



▶ **РЕЗЬБОНАРЕЗНОЙ
ИНСТРУМЕНТ**

ИЗГОТОВЛЕНИЕ ВНУТРЕННЕЙ РЕЗЬБЫ

Предварительно необходимо высверлить отверстие под резьбу. Для выбора правильного диаметра отверстия используйте таблицы. Важно: для нарезки резьбы в глухом отверстии необходимо высверлить отверстие на одну заборную часть метчика глубже. Мы рекомендуем Вам раззенковать просверленное отверстие для лёгкого и правильного введения метчика. Закрепите метчик в воротке, или же, при небольших диаметрах метчиков в цанговом воротке. Удостоверьтесь в том, что ручка воротка крепко затянута. Метчик должен входить в отверстие строго перпендикулярно. Под небольшим давлением вворачивайте метчик при помощи воротка по часовой стрелке. После каждого полуоборота необходимо ломать стружку движением против часовой стрелки.

► ВНУТРЕННЯЯ РЕЗЬБА

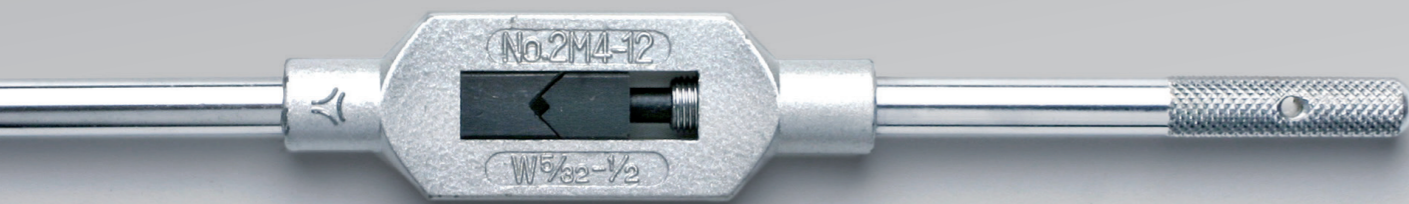

ЧЕТЫРЁГРАННИК ПО DIN 10

для закрепления метчиков в
воротке (vW).

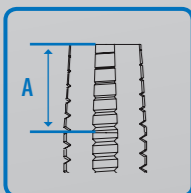

**ПЕРВЫЙ
(ЧЕРНОВОЙ МЕТЧИК)**

Маркирован одним кольцом,
длинная заборная часть,
Форма A / 6-8 витков

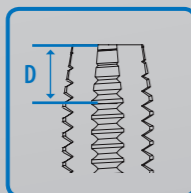

**СРЕДНИЙ
(ПОЛУЧИСТОВОЙ)**

Маркирован двумя кольцами,
средняя заборная часть,
Форма D / 3,5-5 витков

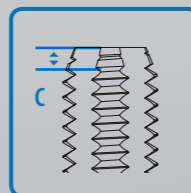

**ТРЕТИЙ
(ЧИСТОВОЙ)**

Без маркировки, короткая
заборная часть,
Форма C / 2-3 витка

**МЕТЧИК
DIN 352 · 3S · M4 · 6H · HSS**

Метчик

DIN 352 = Немецкий институт по стандартизации

3S = Набор метчиков 3-шт.

M4 = размер в мм для метрических
ISO2-резьб в соответствии с DIN 13

6H = класс точности по DIN 802, часть 1

HSS = быстрорежущая сталь
группы сплавов HSS

Маркировка в соответствии с DIN 2197

M4 6H HSS

▶ РУЧНОЙ МЕТЧИК

DIN 352

Набор для метрической
ISO-резьбы состоит из трёх
метчиков - первый (черновой),
средний (получистовой) и
третий (чистовой).

Метчики до M6 имеют
утолщённый хвостовик и 3
канавки. Метчики от M7 имеют
проходной хвостовик и 4
канавки.



ЧЕТЫРЁГРАННИК ПО DIN 10

для закрепления метчиков в
воротке (vW).

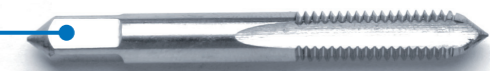
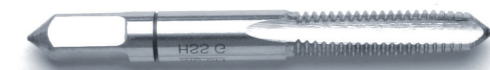

РУЧНОЙ МЕТЧИК	ТЕХНИЧЕСКАЯ ИНФОРМАЦИЯ			
	Норма	DIN 352	Обр. Материал	Сталь
	Резьба	M	Вид отверстия	Сквозное / глухое
	Материал	HSS-G	Направление	правый
			Класс точности	ISO2 / 6h

						Набор	Нр. 1	Нр. 2	Нр. 3	
M 1	0,25	0,75	32	5,5	2,5	2,1	00105010	00104011	00104012	00104013
M 1,1	0,25	0,85	32	5,5	2,5	2,1	00105020	00104021	00104022	00104023
M 1,2	0,25	0,95	32	5,5	2,5	2,1	00105030	00104031	00104032	00104033
M 1,4	0,3	1,1	32	7	2,5	2,1	00105040	00104041	00104042	00104043
M 1,6	0,35	1,25	32	8	2,5	2,1	00105050	00104051	00104052	00104053
M 1,7	0,35	1,3	32	8	2,5	2,1	00105060	00104061	00104062	00104063
M 1,8	0,35	1,45	32	8	2,5	2,1	00105070	00104071	00104072	00104073
M 2	0,4	1,6	36	8	2,8	2,1	00105080	00104081	00104082	00104083
M 2,2	0,45	1,75	36	9	2,8	2,1	00105090	00104091	00104092	00104093
M 2,3	0,4	1,9	36	9	2,8	2,1	00105100	00104101	00104102	00104103
M 2,5	0,45	2,05	40	9	2,8	2,1	00105110	00104111	00104112	00104113
M 2,6	0,45	2,1	40	9	2,8	2,1	00105120	00104121	00104122	00104123
M 3	0,5	2,5	40	11	3,5	2,7	00105130	00104131	00104132	00104133
M 3,5	0,6	2,9	45	13	4	3	00105140	00104141	00104142	00104143
M 4	0,7	3,3	45	13	4,5	3,4	00105150	00104151	00104152	00104153
M 4,5	0,75	3,7	50	16	6	4,9	00105160	00104161	00104162	00104163
M 5	0,8	4,2	50	16	6	4,9	00105170	00104171	00104172	00104173
M 6	1,0	5,0	56	19	6	4,9	00105190	00104191	00104192	00104193
M 7	1,0	6,0	56	19	6	4,9	00105200	00104201	00104202	00104203
M 8	1,25	6,8	63	22	6	4,9	00105210	00104211	00104212	00104213
M 9	1,25	7,8	63	22	7	5,5	00105220	00104221	00104222	00104223
M 10	1,5	8,5	70	24	7	5,5	00105230	00104231	00104232	00104233
M 11	1,5	9,5	70	24	8	6,2	00105240	00104241	00104242	00104243
M 12	1,75	10,2	75	28	9	7	00105250	00104251	00104252	00104253
M 14	2,0	12,0	80	30	11	9	00105260	00104261	00104262	00104263
M 16	2,0	14,0	80	32	12	9	00105270	00104271	00104272	00104273
M 18	2,5	15,5	95	34	14	11	00105280	00104281	00104282	00104283
M 20	2,5	17,5	95	34	16	12	00105290	00104291	00104292	00104293
M 22	2,5	19,5	100	34	18	14,5	00105300	00104301	00104302	00104303
M 24	3,0	21,0	110	38	18	14,5	00105310	00104311	00104312	00104313
M 27	3,0	24,0	110	38	20	16	00105320	00104321	00104322	00104323
M 30	3,5	26,5	125	45	22	18	00105330	00104331	00104332	00104333

							Набор	Нр. 1	Нр. 2	Нр. 3
M 33	3,5	29,5	125	50	25	20	00105340	00104341	00104342	00104343
M 36	4,0	32,0	150	56	28	22	00105350	00104351	00104352	00104353
M 39	4,0	35,0	150	60	32	24	00105360	00104361	00104362	00104363
M 42	4,5	37,5	150	60	32	24	00105370	00104371	00104372	00104373
M 45	4,5	40,5	160	65	36	29	00105380	00104381	00104382	00104383
M 48	5,0	43,0	180	70	36	29	00105390	00104391	00104392	00104393
M 52	5,0	47,0	180	70	40	32	00105400	00104401	00104402	00104403
M 56	5,5	50,5	180	70	40	32	00105410	00104411	00104412	00104413
M 60	5,5	54,5	200	75	45	35	00105420	00104421	00104422	00104423
M 64	6,0	58,0	220	80	50	39	00105430	00104431	00104432	00104433

РУЧНОЙ МЕТЧИК	ТЕХНИЧЕСКАЯ ИНФОРМАЦИЯ			
	Норма	DIN 352	Обр. Материал	VA-Сталь
	Резьба	M	Вид отверстия	Сквозное / глухое
	Материал	HSSE-G	Направление	правый
			Класс точности	ISO2 / 6h

							Набор	Нр. 1	Нр. 2	Нр. 3
M 3	0,5	2,5	40	12	3,5	2,7	00107130	00106131	00106132	00106133
M 4	0,7	3,3	45	14	4,5	3,4	00107150	00106151	00106152	00106153
M 5	0,8	4,2	50	16	6	4,9	00107170	00106171	00106172	00106173
M 6	1,0	5,0	56	19	6	4,9	00107190	00106191	00106192	00106193
M 8	1,25	6,8	63	22	6	4,9	00107210	00106211	00106212	00106213
M 10	1,5	8,5	70	25	7	5,5	00107230	00106231	00106232	00106233
M 12	1,75	10,2	75	28	9	7	00107250	00106251	00106252	00106253
M 14	2,0	12,0	80	32	11	9	00107260	00106261	00106262	00106263
M 16	2,0	14,0	80	32	12	9	00107270	00106271	00106272	00106273
M 18	2,5	15,5	95	34	14	11	00107280	00106281	00106282	00106283
M 20	2,5	17,5	95	34	16	12	00107290	00106291	00106292	00106293
M 22	2,5	19,5	100	34	18	14,5	00107300	00106301	00106302	00106303
M 24	3,0	21,0	110	38	18	14,5	00107310	00106311	00106312	00106313
M 27	3,0	24,0	110	38	20	16	00107320	00106321	00106322	00106323
M 30	3,5	26,5	125	45	22	18	00107330	00106331	00106332	00106333
M 33	3,5	29,5	125	50	25	20	00107340	00106341	00106342	00106343
M 36	4,0	32,0	150	56	28	22	00107350	00106351	00106352	00106353
M 39	4,0	35,0	150	60	32	24	00107360	00106361	00106362	00106363

								Набор	Нр. 1	Нр. 2	Нр. 3
M 42	4,5	37,5	150	60	32	24		00107370	00106371	00106372	00106373
M 45	4,5	40,5	160	65	36	29		00107380	00106381	00106382	00106383
M 48	5,0	43,0	180	70	36	29		00107390	00106391	00106392	00106393
M 52	5,0	47,0	180	70	40	32		00107400	00106401	00106402	00106403
M 56	5,5	51,5	180	70	40	32		00107410	00106411	00106412	00106413
M 60	5,5	54,5	200	75	45	35		00107420	00106421	00106422	00106423
M 64	6,0	58,0	220	80	50	39		00107430	00106431	00106432	00106433

ЧЕРНОВОЙ МЕТЧИК С ЦАПФОЙ

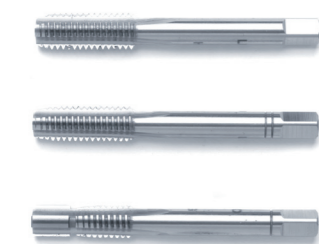

ТЕХНИЧЕСКАЯ ИНФОРМАЦИЯ

Норма	DIN 352	Обр. Материал	Сталь
Резьба	M	Вид отверстия	Сквозное / глухое
Материал	HSSE-G	Направление	правый
		Класс точности	ISO2 / 6h

								Набор	Нр. 1	Нр. 2	Нр. 3
M 3	0,5	2,5	40	11	3,5	2,7		00113130	00112131	00112132	00112133
M 4	0,7	3,3	45	13	4,5	3,4		00113150	00112151	00112152	00112153
M 5	0,8	4,2	50	16	6	4,9		00113170	00112171	00112172	00112173
M 6	1,0	5,0	56	19	6	4,9		00113190	00112191	00112192	00112193
M 8	1,25	6,8	63	22	6	4,9		00113210	00112211	00112212	00112213
M 10	1,5	8,5	70	24	7	5,5		00113230	00112231	00112232	00112233
M 12	1,75	10,2	75	28	9	7		00113250	00112251	00112252	00112253
M 14	2,0	12,0	80	32	11	9		00113260	00112261	00112262	00112263
M 16	2,0	14,0	80	32	12	9		00113270	00112271	00112272	00112273
M 18	2,5	15,5	95	34	14	11		00113280	00112281	00112282	00112283
M 20	2,5	17,5	95	34	16	12		00113290	00112291	00112292	00112293
M 22	2,5	19,5	100	34	18	14,5		00113300	00112301	00112302	00112303
M 24	3,0	21,0	110	38	18	14,5		00113310	00112311	00112312	00112313

ЧЕРНОВОЙ МЕТЧИК С ЦАПФОЙ, ВАПОРИЗИРОВАННЫЙ



ТЕХНИЧЕСКАЯ ИНФОРМАЦИЯ

Норма	DIN 352	Обр. Материал	Сталь
Резьба	M	Вид отверстия	Сквозное / глухое
Материал	HSSE-VAP	Направление	правый
		Класс точности	ISO2 / 6h

								Набор	Нр. 1	Нр. 2	Нр. 3
M 3	0,5	2,5	40	11	3,5	2,7		00813130	00812131	00812132	00812133
M 4	0,7	3,3	45	13	4,5	3,4		00813150	00812151	00812152	00812153
M 5	0,8	4,2	50	16	6	4,9		00813170	00812171	00812172	00812173
M 6	1,0	5,0	56	19	6	4,9		00813190	00812191	00812192	00812193
M 8	1,25	6,8	63	22	6	4,9		00813210	00812211	00812212	00812213
M 10	1,5	8,5	70	24	7	5,5		00813230	00812231	00812232	00812233
M 12	1,75	10,2	75	28	9	7		00813250	00812251	00812252	00812253
M 14	2,0	12,0	80	32	11	9		00813260	00812261	00812262	00812263
M 16	2,0	14,0	80	32	12	9		00813270	00812271	00812272	00812273
M 18	2,5	15,5	95	34	14	11		00813280	00812281	00812282	00812283
M 20	2,5	17,5	95	34	16	12		00813290	00812291	00812292	00812293
M 22	2,5	19,5	100	34	18	14,5		00813300	00812301	00812302	00812303
M 24	3,0	21,0	110	38	18	14,5		00813310	00812311	00812312	00812313

РУЧНОЙ МЕТЧИК LH

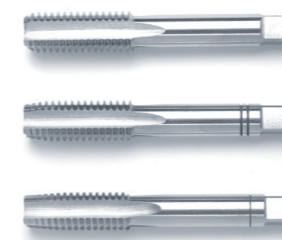

ТЕХНИЧЕСКАЯ ИНФОРМАЦИЯ

Норма	DIN 352	Обр. Материал	Сталь
Резьба	M	Вид отверстия	Сквозное / глухое
Материал	HSS-G	Направление	левый
		Класс точности	ISO2 / 6h

								Набор	Нр. 1	Нр. 2	Нр. 3
M 3	0,5	2,5	40	12	3,5	2,7		00109130	00108131	00108132	00108133
M 4	0,7	3,3	45	14	4,5	3,4		00109150	00108151	00108152	00108153
M 5	0,8	4,2	48	16	6	4,9		00109170	00108171	00108172	00108173
M 6	1,0	5,0	56	19	6	4,9		00109190	00108191	00108192	00108193
M 7	1,0	6,0	56	19	6	4,9		00109200	00108201	00108202	00108203
M 8	1,25	6,8	63	22	6	4,9		00109210	00108211	00108212	00108213
M 9	1,25	7,8	63	22	7	5,5		00109220	00108221	00108222	00108223
M 10	1,5	8,5	70	24	7	5,5		00109230	00108231	00108232	00108233

							Набор	Нр. 1	Нр. 2	Нр. 3
M 12	1,75	10,2	75	28	9	7	00109250	00108251	00108252	00108253
M 14	2,0	12,0	80	32	11	9	00109260	00108261	00108262	00108263
M 16	2,0	14,0	80	32	12	9	00109270	00108271	00108272	00108273
M 18	2,5	15,5	95	34	14	11	00109280	00108281	00108282	00108283
M 20	2,5	17,5	95	34	16	12	00109290	00108291	00108292	00108293
M 22	2,5	19,5	100	34	18	14,5	00109300	00108301	00108302	00108303
M 24	3,0	21,0	110	38	18	14,5	00109310	00108311	00108312	00108313
M 27	3,0	24,0	110	38	20	16	00109320	00108321	00108322	00108323
M 30	3,5	26,5	125	45	22	18	00109330	00108331	00108332	00108333
M 33	3,5	29,5	125	50	25	20	00109340	00108341	00108342	00108343
M 36	4,0	32,0	150	56	28	22	00109350	00108351	00108352	00108353
M 39	4,0	35,0	150	60	32	24	00109360	00108361	00108362	00108363
M 42	4,5	37,5	150	60	32	24	00109370	00108371	00108372	00108373
M 45	4,5	40,5	160	65	36	29	00109380	00108381	00108382	00108383
M 48	5,0	43,0	180	70	36	29	00109390	00108391	00108392	00108393
M 52	5,0	47,0	180	70	40	32	00109400	00108401	00108402	00108403
M 56	5,5	51,5	180	70	40	35	00109410	00108411	00108412	00108413
M 60	5,5	54,5	200	75	45	35	00109420	00108421	00108422	00108423
M 64	6,0	58,0	220	80	50	39	00109430	00108431	00108432	00108433

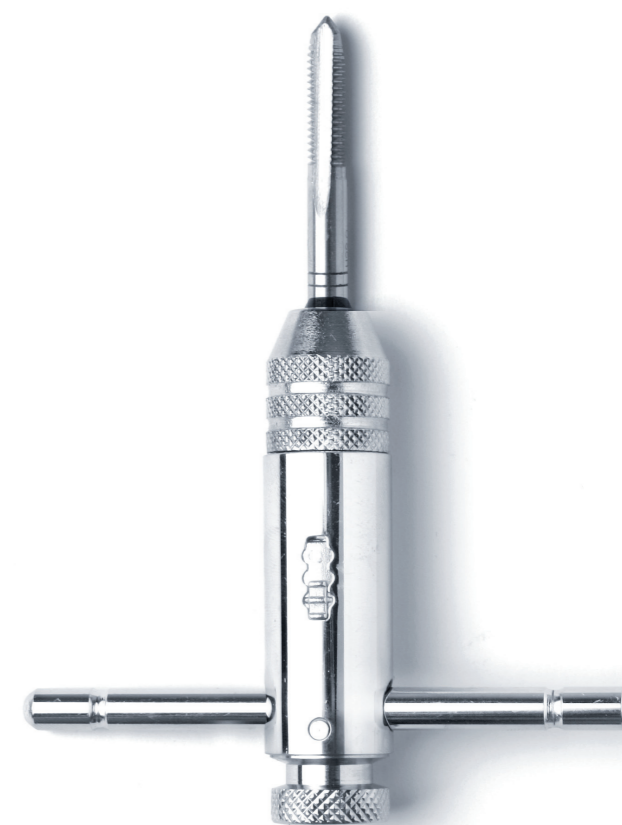

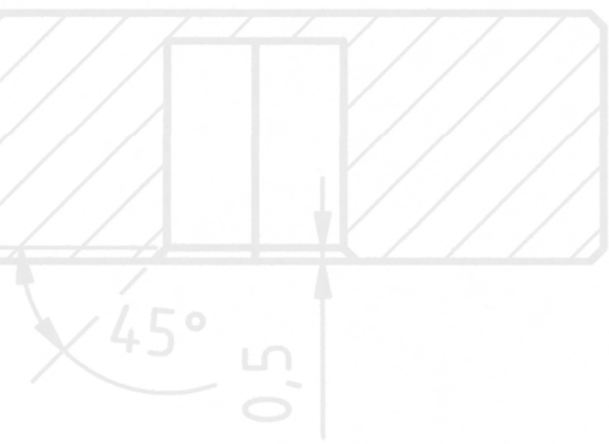

МЕТЧИК
DIN 2181 · 2S · M4 × 0,5 · 6H · HSS

Обозначение
DIN 2181 = Немецкий институт по стандартизации
2S = Набор метчиков 2-шт.
M4 × 0,5 = размер в мм для метрических ISO2-резьб в соответствии с DIN 13
6H = класс точности по DIN 802, часть 1
HSS = быстрорежущая сталь группы сплавов HSS

Маркировка в соответствии с DIN 2197
M4 × 0,5 6H HSS



ЧЕТЫРЁГРАННИК ПО DIN 10
для закрепления метчиков в воротке (vW).

▶ **РУЧНОЙ МЕТЧИК**

DIN 2181

ЗАЖИМ

в ключе с трещёткой



Набор для метрической ISO-мелкой резьбы состоит из трёх метчиков - первый (черновой), средний (получистовой) и третий (чистовой).

Метчики до M6,5 имеют утолщённый хвостовик и 3 канавки. Метчики от M6,5 имеют проходной хвостовик и 4 канавки.

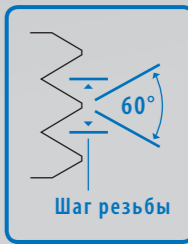
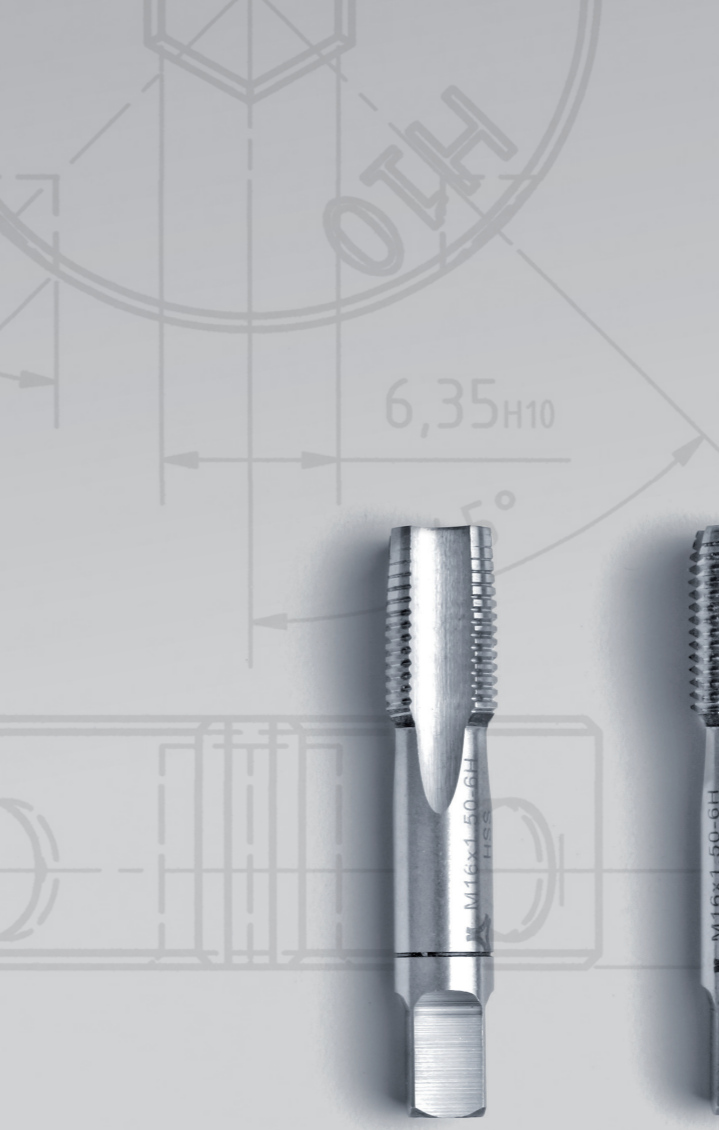

РЕЗЬБА С МЕТРИЧЕСКИМ ПРОФИЛЕМ

ЧЕТЫРЁГРАННИК ПО DIN 10
для закрепления метчиков в воротке (vW).

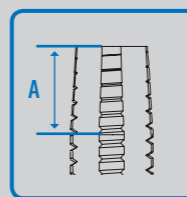

ПЕРВЫЙ (ЧЕРНОВОЙ МЕТЧИК)

Маркирован одним кольцом, длинная заборная часть, Форма А / 6-8 витков

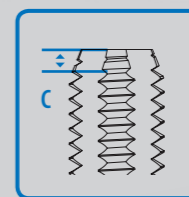

ТРЕТИЙ (ЧИСТОВОЙ)

Без маркировки, короткая заборная часть, Форма С / 2-3 витка

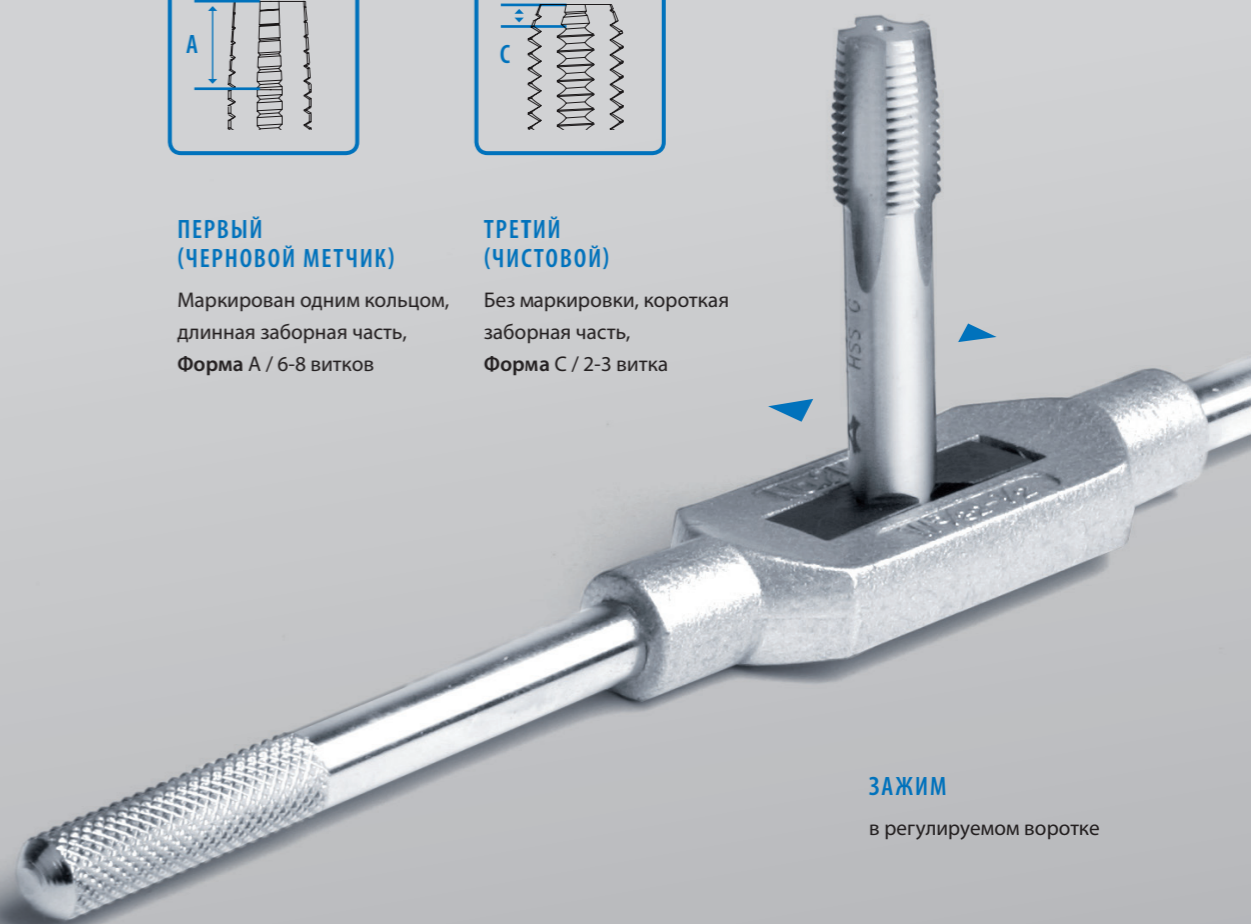

ЗАЖИМ
в регулируемом воротке

							Набор	Нр. 1	Нр. 2
MF 22 x 2	2,0	20,0	80	22	18,0	14,5	00122060	00120061	00120063
MF 23 x 1	1,0	22,0	80	22	18,0	14,5	00122070	00120071	00120073
MF 23 x 1,5	1,5	21,5	80	22	18,0	14,5	00122080	00120081	00120083
MF 24 x 0,5	0,5	23,5	90	22	18,0	14,5	00122090	00120091	00120093
MF 24 x 0,75	0,75	23,25	90	22	18,0	14,5	00122100	00120101	00120103
MF 24 x 1	1,0	23,0	90	22	18,0	14,5	00122110	00120111	00120113
MF 24 x 1,25	1,25	22,75	90	22	18,0	14,5	00122120	00120121	00120123
MF 24 x 1,5	1,5	22,5	90	22	18,0	14,5	00122130	00120131	00120133
MF 24 x 2	2,0	22,0	90	22	18,0	14,5	00122140	00120141	00120143
MF 25 x 1	1,0	24,0	90	22	18,0	14,5	00122150	00120151	00120153
MF 25 x 1,5	1,5	23,5	90	22	18,0	14,5	00122170	00120171	00120173
MF 25 x 2	2,0	23,0	90	22	18,0	14,5	00122180	00120181	00120183
MF 26 x 1	1,0	25,0	90	22	18,0	14,5	00122190	00120191	00120193
MF 26 x 1,25	1,25	24,75	90	22	18,0	14,5	00122200	00120201	00120203
MF 26 x 1,5	1,5	24,5	90	22	18,0	14,5	00122210	00120211	00120213
MF 26 x 2	2,0	24,0	90	22	18,0	14,5	00122220	00120221	00120223
MF 27 x 1	1,0	26,0	90	22	20,0	16,0	00122230	00120231	00120233
MF 27 x 1,5	1,5	25,5	90	22	20,0	16,0	00122240	00120241	00120243
MF 27 x 2	2,0	25,0	90	22	20,0	16,0	00122250	00120251	00120253
MF 28 x 1	1,0	27,0	90	22	20,0	16,0	00122260	00120261	00120263
MF 28 x 1,5	1,5	26,5	90	22	20,0	16,0	00122270	00120271	00120273
MF 28 x 2	2,0	26,0	90	22	20,0	16,0	00122280	00120281	00120283
MF 30 x 1	1,0	29,0	90	22	22,0	18,0	00122290	00120291	00120293
MF 30 x 1,5	1,5	28,5	90	22	22,0	18,0	00122300	00120301	00120303
MF 30 x 2	2,0	28,0	90	22	22,0	18,0	00122310	00120311	00120313
MF 30 x 3	3,0	27,0	125	45	22,0	18,0	00122320	00120321	00120323
MF 32 x 1	1,0	31,0	90	22	22,0	18,0	00122330	00120331	00120333
MF 32 x 1,5	1,5	30,5	90	22	22,0	18,0	00122340	00120341	00120343
MF 32 x 2	2,0	30,0	90	22	22,0	18,0	00122350	00120351	00120353
MF 32 x 3	3,0	29,0	125	45	22,0	18,0	00122360	00120361	00120363
MF 33 x 1	1,0	32,0	100	25	25,0	20,0	00122370	00120371	00120373
MF 33 x 1,5	1,5	31,5	100	25	25,0	20,0	00122380	00120381	00120383
MF 33 x 2	2,0	31,0	100	25	25,0	20,0	00122390	00120391	00120393
MF 33 x 3	3,0	30,0	125	50	25,0	20,0	00122400	00120401	00120403
MF 34 x 1	1,0	33,0	100	25	28,0	22,0	00122410	00120411	00120413
MF 34 x 1,5	1,5	32,5	100	25	28,0	22,0	00122420	00120421	00120423
MF 34 x 2	2,0	32,0	125	40	28,0	22,0	00122430	00120431	00120433
MF 34 x 3	3,0	31,0	125	40	28,0	22,0	00122440	00120441	00120443
MF 35 x 1	1,0	34,0	100	25	28,0	22,0	00122450	00120451	00120453
MF 35 x 1,5	1,5	33,5	100	25	28,0	22,0	00122460	00120461	00120463
MF 35 x 2	2,0	33,0	125	40	28,0	22,0	00122470	00120471	00120473
MF 35 x 3	3,0	32,0	125	40	28,0	22,0	00122480	00120481	00120483
MF 36 x 1	1,0	35,0	100	25	28,0	22,0	00122490	00120491	00120493
MF 36 x 1,5	1,5	34,5	100	25	28,0	22,0	00122500	00120501	00120503

							Набор	Нр. 1	Нр. 2
MF 36 x 2	2,0	34,0	125	40	28,0	22,0	00122510	00120511	00120513
MF 36 x 3	3,0	33,0	125	40	28,0	22,0	00122520	00120521	00120523
MF 38 x 1	1,0	37,0	100	25	28,0	22,0	00122530	00120531	00120533
MF 38 x 1,5	1,5	36,5	100	25	28,0	22,0	00122540	00120541	00120543
MF 38 x 2	2,0	36,0	125	40	28,0	22,0	00122550	00120551	00120553
MF 38 x 3	3,0	35,0	125	40	28,0	22,0	00122560	00120561	00120563
MF 39 x 1,5	1,5	37,5	110	25	32,0	24,0	00122570	00120571	00120573
MF 39 x 2	2,0	37,0	125	40	32,0	24,0	00122580	00120581	00120583
MF 39 x 3	3,0	36,0	125	40	32,0	24,0	00122590	00120591	00120593
MF 40 x 1	1,0	39,0	110	25	32,0	24,0	00122600	00120601	00120603
MF 40 x 1,5	1,5	38,5	110	25	32,0	24,0	00122610	00120611	00120613
MF 40 x 2	2,0	38,0	125	40	32,0	24,0	00122620	00120621	00120623
MF 40 x 3	3,0	37,0	125	40	32,0	24,0	00122630	00120631	00120633
MF 42 x 1,5	1,5	40,5	110	25	32,0	24,0	00122640	00120641	00120643
MF 42 x 2	2,0	40,0	125	40	32,0	24,0	00122650	00120651	00120653
MF 42 x 3	3,0	39,0	125	40	32,0	24,0	00122660	00120661	00120663
MF 42 x 4	4,0	38,0	160	65	32,0	24,0	00122670	00120671	00120673
MF 45 x 1	1,0	44,0	110	25	36,0	29,0	00122680	00120681	00120683
MF 45 x 1,5	1,5	43,5	110	25	36,0	29,0	00122690	00120691	00120693
MF 45 x 2	2,0	43,0	125	40	36,0	29,0	00122700	00120701	00120703
MF 45 x 3	3,0	42,0	125	40	36,0	29,0	00122710	00120711	00120713
MF 45 x 4	4,0	41,0	160	65	36,0	29,0	00122720	00120721	00120723
MF 48 x 1	1,0	47,0	140	40	36,0	29,0	00122730	00120731	00120733
MF 48 x 1,5	1,5	46,5	140	40	36,0	29,0	00122740	00120741	00120743
MF 48 x 2	2,0	46,0	140	40	36,0	29,0	00122750	00120751	00120753
MF 48 x 3	3,0	45,0	140	40	36,0	29,0	00122760	00120761	00120763
MF 48 x 4	4,0	44,0	140	40	36,0	29,0	00122770	00120771	00120773
MF 50 x 1	1,0	49,0	140	40	36,0	29,0	00122780	00120781	00120783
MF 50 x 1,5	1,5	48,5	140	40	36,0	29,0	00122790	00120791	00120793
MF 50 x 2	2,0	48,0	140	40	36,0	29,0	00122800	00120801	00120803
MF 50 x 3	3,0	47,0	140	40	36,0	29,0	00122810	00120811	00120813
MF 50 x 4	4,0	46,0	160	65	40,0	32,0	00122820	00120821	00120823
MF 52 x 1	1,0	51,0	140	40	40,0	32,0	00122830	00120831	00120833
MF 52 x 1,5	1,5	50,5	140	40	40,0	32,0	00122840	00120841	00120843
MF 52 x 2	2,0	50,0	140	40	40,0	32,0	00122850	00120851	00120853
MF 52 x 3	3,0	49,0	140	40	40,0	32,0	00122860	00120861	00120863
MF 52 x 4	4,0	48,0	160	65	40,0	32,0	00122870	00120871	00120873

РУЧНОЙ МЕТЧИК

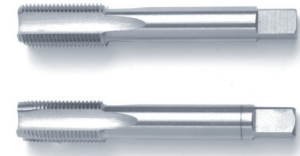

ТЕХНИЧЕСКАЯ ИНФОРМАЦИЯ

Норма	DIN 2181	Обр. Материал	Сталь
Резьба	MF	Вид отверстия	Сквозное / глухое
Материал	HSSE-G	Направление	правый
		Класс точности	ISO2 / 6h

							Набор	Нр. 1	Нр. 2
MF 2,5 × 0,35	0,35	2,15	40	8	2,8	2,1	00142150	00142151	00142153
MF 2,6 × 0,35	0,35	2,15	40	8	2,8	2,1	00142161	00142161	00142163
MF 3 × 0,35	0,35	2,65	40	8	3,5	2,7	00142200	00138201	00138203
MF 3,5 × 0,35	0,35	3,15	45	9	4,0	3,0	00142220	00138221	00138223
MF 4 × 0,35	0,35	3,65	45	10	4,5	3,4	00142230	00138231	00138233
MF 4 × 0,5	0,5	3,5	45	10	4,5	3,4	00142240	00138241	00138243
MF 4,5 × 0,35	0,35	4,15	50	12	6,0	3,4	00142250	00138251	00138253
MF 4,5 × 0,5	0,5	4,0	50	12	6,0	3,4	00142260	00138261	00138263
MF 5 × 0,5	0,5	4,5	50	12	6,0	4,9	00142280	00138281	00138283
MF 5 × 0,75	0,75	4,25	50	12	6,0	4,9	00142290	00138291	00138293
MF 5,5 × 0,5	0,5	5,0	56	12	6,0	4,9	00142300	00138301	00138303
MF 5,5 × 0,75	0,75	4,75	56	12	6,0	4,9	00142310	00138311	00138313
MF 6 × 0,5	0,5	5,5	56	14	6,0	4,9	00142320	00138321	00138323
MF 6 × 0,75	0,75	5,25	56	14	6,0	4,9	00142330	00138331	00138333
MF 7 × 0,5	0,5	6,5	56	14	6,0	4,9	00142350	00138351	00138353
MF 7 × 0,75	0,75	6,25	56	14	6,0	4,9	00142360	00138361	00138363
MF 8 × 0,5	0,5	7,5	56	18	6,0	4,9	00142380	00138381	00138383
MF 8 × 0,75	0,75	7,25	56	18	6,0	4,9	00142390	00138391	00138393
MF 8 × 1	1,0	7,0	63	22	6,0	4,9	00142400	00138401	00138403
MF 8 × 1,5	1,5	6,5	63	22	6,0	4,9	00142410	00138411	00138413
MF 9 × 0,5	0,5	8,5	63	22	7,0	5,5	00142420	00138421	00138423
MF 9 × 0,75	0,75	8,25	63	22	7,0	5,5	00142430	00138431	00138433
MF 9 × 1	1,0	8,0	63	22	7,0	5,5	00142440	00138441	00138443
MF 10 × 0,5	0,5	9,5	63	20	7,0	5,5	00142450	00138451	00138453
MF 10 × 0,75	0,75	9,25	63	20	7,0	5,5	00142460	00138461	00138463
MF 10 × 1	1,0	9,0	63	20	7,0	5,5	00142470	00138471	00138473
MF 10 × 1,25	1,25	8,8	70	24	7,0	5,5	00142480	00138481	00138483
MF 11 × 0,5	0,5	10,5	63	20	8,0	6,2	00142490	00138491	00138493
MF 11 × 0,75	0,75	10,25	63	20	8,0	6,2	00142500	00138501	00138503
MF 11 × 1	1,0	10,0	63	20	8,0	6,2	00142510	00138511	00138513
MF 11 × 1,25	1,25	9,75	70	22	8,0	6,2	00142520	00138521	00138523
MF 12 × 0,5	0,5	11,5	70	22	9,0	7,0	00142530	00138531	00138533
MF 12 × 0,75	0,75	11,25	70	22	9,0	7,0	00142540	00138541	00138543
MF 12 × 1	1,0	11,0	70	22	9,0	7,0	00142550	00138551	00138553
MF 12 × 1,25	1,25	10,8	70	22	9,0	7,0	00142560	00138561	00138563
MF 12 × 1,5	1,5	10,5	70	22	9,0	7,0	00142570	00138571	00138573

							Набор	Нр. 1	Нр. 2
MF 13 × 0,5	0,5	12,5	70	22	11,0	9,0	00142580	00138581	00138583
MF 13 × 0,75	0,75	12,25	70	22	11,0	9,0	00142590	00138591	00138593
MF 13 × 1	1,0	12,0	70	22	11,0	9,0	00142600	00138601	00138603
MF 13 × 1,25	1,25	11,75	70	22	11,0	9,0	00142610	00138611	00138613
MF 13 × 1,5	1,5	11,5	70	22	11,0	9,0	00142620	00138621	00138623
MF 14 × 0,5	0,5	13,5	70	22	11,0	9,0	00142630	00138631	00138633
MF 14 × 0,75	0,75	13,25	70	22	11,0	9,0	00142640	00138641	00138643
MF 14 × 1	1,0	13,0	70	22	11,0	9,0	00142650	00138651	00138653
MF 14 × 1,25	1,25	12,8	70	22	11,0	9,0	00142660	00138661	00138663
MF 14 × 1,5	1,5	12,5	70	22	11,0	9,0	00142670	00138671	00138673
MF 15 × 0,5	0,5	14,5	70	22	12,0	9,0	00142680	00138681	00138683
MF 15 × 0,75	0,75	14,25	70	22	12,0	9,0	00142690	00138691	00138693
MF 15 × 1	1,0	14,0	70	22	12,0	9,0	00142700	00138701	00138703
MF 15 × 1,25	1,25	13,8	70	22	12,0	9,0	00142710	00138711	00138713
MF 15 × 1,5	1,5	13,5	70	22	12,0	9,0	00142720	00138721	00138723
MF 16 × 0,5	0,5	15,5	70	22	12,0	9,0	00142730	00138731	00138733
MF 16 × 0,75	0,75	15,25	70	22	12,0	9,0	00142740	00138741	00138743
MF 16 × 1	1,0	15,0	70	22	12,0	9,0	00142750	00138751	00138753
MF 16 × 1,25	1,25	14,75	70	22	12,0	9,0	00142760	00138761	00138763
MF 16 × 1,5	1,5	14,5	70	22	12,0	9,0	00142770	00138771	00138773
MF 17 × 0,75	0,75	16,25	70	22	12,0	9,0	00142780	00138781	00138783
MF 17 × 1	1,0	16,0	70	22	12,0	9,0	00142790	00138791	00138793
MF 17 × 1,5	1,5	15,5	70	22	12,0	9,0	00142800	00138801	00138803
MF 18 × 0,5	0,5	17,5	80	22	14,0	11,0	00142820	00138821	00138823
MF 18 × 0,75	0,75	17,25	80	22	14,0	11,0	00142830	00138831	00138833
MF 18 × 1	1,0	17,0	80	22	14,0	11,0	00142840	00138841	00138843
MF 18 × 1,25	1,25	16,75	80	22	14,0	11,0	00142850	00138851	00138853
MF 18 × 1,5	1,5	16,5	80	22	14,0	11,0	00142860	00138861	00138863
MF 18 × 2	2,0	16,0	80	22	14,0	11,0	00142870	00138871	00138873
MF 19 × 1	1,0	18,0	80	22	14,0	11,0	00142880	00138881	00138883
MF 19 × 1,5	1,5	17,5	80	22	14,0	11,0	00142900	00138901	00138903
MF 20 × 0,5	0,5	19,5	80	22	16,0	12,0	00142910	00138911	00138913
MF 20 × 0,75	0,75	19,25	80	22	16,0	12,0	00142920	00138921	00138923
MF 20 × 1	1,0	19,0	80	22	16,0	12,0	00142930	00138931	00138933
MF 20 × 1,25	1,25	18,75	80	22	16,0	12,0	00142940	00138941	00138943
MF 20 × 1,5	1,5	18,5	80	22	16,0	12,0	00142950	00138951	00138953
MF 20 × 2	2,0	18,0	80	22	16,0	12,0	00142960	00138961	00138963
MF 21 × 1	1,0	20,0	80	22	16,0	12,0	00142980	00138981	00138983
MF 21 × 1,5	1,5	19,5	80	22	16,0	12,0	00143000	00139001	00139003
MF 22 × 0,5	0,5	21,5	80	22	18,0	14,5	00143010	00139011	00139013
MF 22 × 0,75	0,75	21,25	80	22	18,0	14,5	00143020	00139021	00139023
MF 22 × 1	1,0	21,0	80	22	18,0	14,5	00143030	00139031	00139033
MF 22 × 1,25	1,25	20,75	80	22	18,0	14,5	00143040	00139041	00139043
MF 22 × 1,5	1,5	20,5	80	22	18,0	14,5	00143050	00139051	00139053

							Набор	Нр. 1	Нр. 2
MF 22 × 2	2,0	20,0	80	22	18,0	14,5	00143060	00139061	00139063
MF 23 × 1	1,0	22,0	80	22	18,0	14,5	00143070	00139071	00139073
MF 23 × 1,5	1,5	21,5	80	22	18,0	14,5	00143080	00139081	00139083
MF 24 × 0,5	0,5	23,5	90	22	18,0	14,5	00143090	00139091	00139093
MF 24 × 0,75	0,75	23,25	90	22	18,0	14,5	00143100	00139101	00139103
MF 24 × 1	1,0	23,0	90	22	18,0	14,5	00143110	00139111	00139113
MF 24 × 1,25	1,25	22,75	90	22	18,0	14,5	00143120	00139121	00139123
MF 24 × 1,5	1,5	22,5	90	22	18,0	14,5	00143130	00139131	00139133
MF 24 × 2	2,0	22,0	90	22	18,0	14,5	00143140	00139141	00139143
MF 25 × 1	1,0	24,0	90	22	18,0	14,5	00143150	00139151	00139153
MF 25 × 1,5	1,5	23,5	90	22	18,0	14,5	00143170	00139171	00139173
MF 25 × 2	2,0	23,0	90	22	18,0	14,5	00143180	00139181	00139183
MF 26 × 1	1,0	25,0	90	22	18,0	14,5	00143190	00139191	00139193
MF 26 × 1,25	1,25	24,75	90	22	18,0	14,5	00143200	00139201	00139203
MF 26 × 1,5	1,5	24,5	90	22	18,0	14,5	00143210	00139211	00139213
MF 26 × 2	2,0	24,0	90	22	18,0	14,5	00143220	00139221	00139223
MF 27 × 1	1,0	26,0	90	22	20,0	16,0	00143230	00139231	00139233
MF 27 × 1,5	1,5	25,5	90	22	20,0	16,0	00143240	00139241	00139243
MF 27 × 2	2,0	25,0	90	22	20,0	16,0	00143250	00139251	00139253
MF 28 × 1	1,0	27,0	90	22	20,0	16,0	00143260	00139261	00139263
MF 28 × 1,5	1,5	26,5	90	22	20,0	16,0	00143270	00139271	00139273
MF 28 × 2	2,0	26,0	90	22	20,0	16,0	00143280	00139281	00139283
MF 30 × 1	1,0	29,0	90	22	22,0	18,0	00143290	00139291	00139293
MF 30 × 1,5	1,5	28,5	90	22	22,0	18,0	00143300	00139301	00139303
MF 30 × 2	2,0	28,0	90	22	22,0	18,0	00143310	00139311	00139313
MF 30 × 3	3,0	27,0	125	45	22,0	18,0	00143320	00139321	00139323
MF 32 × 1	1,0	31,0	90	22	22,0	18,0	00143330	00139331	00139333
MF 32 × 1,5	1,5	30,5	90	22	22,0	18,0	00143340	00139341	00139343
MF 32 × 2	2,0	30,0	90	22	22,0	18,0	00143350	00139351	00139353
MF 32 × 3	3,0	29,0	125	45	22,0	18,0	00143360	00139361	00139363
MF 33 × 1	1,0	32,0	100	25	25,0	20,0	00143370	00139371	00139373
MF 33 × 1,5	1,5	31,5	100	25	25,0	20,0	00143380	00139381	00139383
MF 33 × 2	2,0	31,0	100	25	25,0	20,0	00143390	00139391	00139393
MF 33 × 3	3,0	30,0	125	50	25,0	20,0	00143400	00139401	00139403
MF 34 × 1	1,0	33,0	100	25	28,0	22,0	00143410	00139411	00139413
MF 34 × 1,5	1,5	32,5	100	25	28,0	22,0	00143420	00139421	00139423
MF 34 × 2	2,0	32,0	125	40	28,0	22,0	00143430	00139431	00139433
MF 34 × 3	3,0	31,0	125	40	28,0	22,0	00143440	00139441	00139443
MF 35 × 1	1,0	34,0	100	25	28,0	22,0	00143450	00139451	00139453
MF 35 × 1,5	1,5	33,5	100	25	28,0	22,0	00143460	00139461	00139463
MF 35 × 2	2,0	33,0	125	40	28,0	22,0	00143470	00139471	00139473
MF 35 × 3	3,0	32,0	125	40	28,0	22,0	00143480	00139481	00139483

							Набор	Нр. 1	Нр. 2
MF 36 × 1	1,0	35,0	100	25	28,0	22,0	00143490	00139491	00139493
MF 36 × 1,5	1,5	34,5	100	25	28,0	22,0	00143500	00139501	00139503
MF 36 × 2	2,0	34,0	125	40	28,0	22,0	00143510	00139511	00139513
MF 36 × 3	3,0	33,0	125	40	28,0	22,0	00143520	00139521	00139523

РУЧНОЙ МЕТЧИК LH

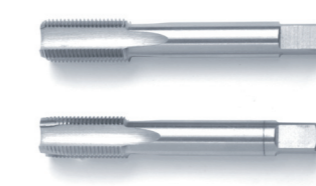

ТЕХНИЧЕСКАЯ ИНФОРМАЦИЯ

Норма	DIN 2181	Обр. Материал	Сталь
Резьба	MF	Вид отверстия	Сквозное / глухое
Материал	HSS-G	Направление	левый
		Класс точности	ISO2 / 6h

							Набор	Нр. 1	Нр. 2
MF 6 × 0,75	0,75	5,25	56	14	6,0	4,9	00117330	00116331	00116333
MF 8 × 0,75	0,75	7,25	56	18	6,0	4,9	00117390	00116391	00116393
MF 8 × 1	1,0	7,0	63	22	6,0	4,9	00117400	00116401	00116403
MF 10 × 1	1,0	9,0	63	20	7,0	5,5	00117470	00116471	00116473
MF 10 × 1,25	1,25	8,8	70	24	7,0	5,5	00117480	00116481	00116483
MF 12 × 1	1,0	11,0	70	22	9,0	7,0	00117550	00116551	00116553
MF 12 × 1,25	1,25	10,8	70	22	9,0	7,0	00117560	00116561	00116563
MF 12 × 1,5	1,5	10,5	70	22	9,0	7,0	00117570	00116571	00116573
MF 14 × 1	1,0	13,0	70	22	11,0	9,0	00117650	00116651	00116653
MF 14 × 1,25	1,25	12,8	70	22	11,0	9,0	00117660	00116661	00116663
MF 14 × 1,5	1,5	12,5	70	22	11,0	9,0	00117670	00116671	00116673
MF 16 × 1	1,0	15,0	70	22	12,0	9,0	00117750	00116751	00116753
MF 16 × 1,5	1,5	14,5	70	22	12,0	9,0	00117770	00116771	00116773
MF 18 × 1,5	1,5	16,5	80	22	14,0	11,0	00117860	00116861	00116863
MF 20 × 1,5	1,5	18,5	80	22	16,0	12,0	00117950	00116951	00116953
MF 22 × 1,5	1,5	20,5	80	22	18,0	14,5	00126050	00124051	00124053
MF 24 × 2	2,0	22,0	90	22	18,0	14,5	00126140	00124141	00124143
MF 30 × 1,5	1,5	28,5	90	22	22,0	18,0	00126300	00124301	00124303
MF 30 × 2	2,0	28,0	90	22	22,0	18,0	00126310	00124311	00124313

РУЧНОЙ МЕТЧИК

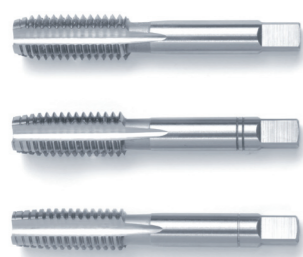

ТЕХНИЧЕСКАЯ ИНФОРМАЦИЯ

Норма	DIN 2184-2 (~DIN352)
Резьба	BSW
Материал	HSS-G
Обр. Материал	Сталь
Вид отверстия	Сквозное / глухое
Направление	правый

BSW	60	1,2	32	8	2,5	2,1	Набор	Нр. 1	Нр. 2	Нр. 3
BSW 1/16	60	1,2	32	8	2,5	2,1	00135010	00134011	00134012	00134013
BSW 3/32	48	1,9	40	9	2,8	2,1	00135020	00134021	00134022	00134023
BSW 1/8	40	2,6	40	11	3,5	2,7	00135030	00134031	00134032	00134033
BSW 5/32	32	3,2	45	13	4,5	3,4	00135040	00134041	00134042	00134043
BSW 3/16	24	3,8	50	16	6,0	4,9	00135050	00134051	00134052	00134053
BSW 7/32	24	4,6	56	17	6,0	4,9	00135060	00134061	00134062	00134063
BSW 1/4	20	5,1	56	19	6,0	4,9	00135070	00134071	00134072	00134073
BSW 5/16	18	6,5	63	22	6,0	4,9	00135080	00134081	00134082	00134083
BSW 3/8	16	7,9	70	24	7,0	5,5	00135090	00134091	00134092	00134093
BSW 7/16	14	9,3	70	24	8,0	6,2	00135100	00134101	00134102	00134103
BSW 1/2	12	10,5	75	28	9,0	7,0	00135110	00134111	00134112	00134113
BSW 9/16	12	12,0	80	30	11,0	9,0	00135120	00134121	00134122	00134123
BSW 5/8	11	13,5	80	32	12,0	9,0	00135130	00134131	00134132	00134133
BSW 3/4	10	16,5	95	34	14,0	11,0	00135140	00134141	00134142	00134143
BSW 7/8	9	19,5	100	34	18,0	14,5	00135150	00134151	00134152	00134153
BSW 1	8	22,0	110	38	18,0	14,5	00135160	00134161	00134162	00134163
BSW 1.1/8	7	25,0	125	45	22,0	18,0	00135170	00134171	00134172	00134173
BSW 1.1/4	7	28,0	125	45	22,0	18,0	00135180	00134181	00134182	00134183
BSW 1.3/8	6	30,5	150	56	28,0	22,0	00135190	00134191	00134192	00134193
BSW 1.1/2	6	33,5	150	56	28,0	22,0	00135200	00134201	00134202	00134203
BSW 1.5/8	5	35,5	150	60	32,0	24,0	00135210	00134211	00134212	00134213
BSW 1.3/4	5	39,0	160	65	36,0	29,0	00135220	00134221	00134222	00134223
BSW 1.7/8	4,5	41,5	180	70	36,0	29,0	00135230	00134231	00134232	00134233
BSW 2	4,5	44,5	180	70	40,0	32,0	00135240	00134241	00134242	00134243
BSW 2.1/4	4	50,8	200	75	45,0	35,0	00135250	00134251	00134252	00134253
BSW 2.1/2	4	57,15	220	80	50,0	39,0	00135260	00134261	00134262	00134263
BSW 2.3/4	3,5	62,6	240	80	50,0	39,0	00135270	00134271	00134272	00134273
BSW 3	3,5	68,95	260	85	50,0	39,0	00135280	00134281	00134282	00134283

РУЧНОЙ МЕТЧИК

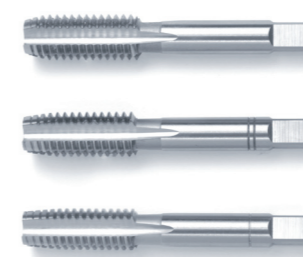

ТЕХНИЧЕСКАЯ ИНФОРМАЦИЯ

Норма	ISO 529	Обр. Материал	Сталь
Резьба	BSW	Вид отверстия	Сквозное / глухое
Материал	HSS-G	Направление	правый

BSW	40	2,6	48	11	3,15	2,5	Набор	Нр. 1	Нр. 2	Нр. 3
BSW 1/8	40	2,6	48	11	3,15	2,5	00137030	00136031	00136032	00136033
BSW 5/32	32	3,2	55	13	4,5	3,55	00137040	00136041	00136042	00136043
BSW 3/16	24	3,8	58	16	5,0	4,0	00137050	00136051	00136052	00136053
BSW 1/4	20	5,1	66	19	6,3	5,0	00137070	00136071	00136072	00136073
BSW 5/16	18	6,5	72	22	8,0	6,3	00137080	00136081	00136082	00136083
BSW 3/8	16	7,9	80	24	10,0	8,0	00137090	00136091	00136092	00136093
BSW 7/16	14	9,3	85	25	8,0	6,3	00137100	00136101	00136102	00136103
BSW 1/2	12	10,5	89	29	9,0	7,1	00137110	00136111	00136112	00136113
BSW 9/16	12	12,0	95	30	11,2	9,0	00137120	00136121	00136122	00136123
BSW 5/8	11	13,5	102	32	12,5	10,0	00137130	00136131	00136132	00136133
BSW 3/4	10	16,5	112	37	14,0	11,2	00137140	00136141	00136142	00136143
BSW 7/8	9	19,5	118	38	16,0	12,5	00137150	00136151	00136152	00136153
BSW 1	8	22,0	130	45	18,0	14,0	00137160	00136161	00136162	00136163
BSW 1.1/8	7	25,0	138	48	20,0	16,0	00137170	00136171	00136172	00136173
BSW 1.1/4	7	28,0	151	51	22,4	18,0	00137180	00136181	00136182	00136183
BSW 1.3/8	6	30,5	162	57	25,0	20,0	00137190	00136191	00136192	00136193
BSW 1.1/2	6	33,5	170	60	28,0	22,4	00137200	00136201	00136202	00136203
BSW 1.3/4	5	39,0	187	67	31,5	25,0	00137220	00136221	00136222	00136223
BSW 2	4,5	44,5	200	70	35,5	28,0	00137240	00136241	00136242	00136243

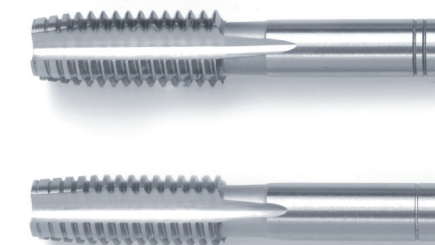

РУЧНОЙ МЕТЧИК LH

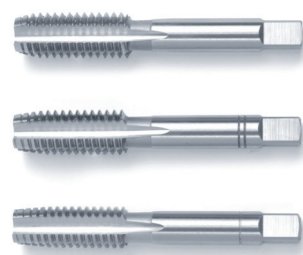

ТЕХНИЧЕСКАЯ ИНФОРМАЦИЯ

Норма	DIN 2184-2 (~DIN352)
Резьба	BSW
Материал	HSS-G
Обр. Материал	Сталь
Вид отверстия	Сквозное / глухое
Направление	правый

↙	↘	↘	↙	↘	↙	◇	Набор	Нр. 1	Нр. 2	Нр. 3
BSW 1/16	60	1,2	32	8	2,5	2,1	00153010	00152011	00152012	00152013
BSW 3/32	48	1,9	40	9	2,8	2,1	00153020	00152021	00152022	00152023
BSW 1/8	40	2,6	40	11	3,5	2,7	00153030	00152031	00152032	00152033
BSW 5/32	32	3,2	45	13	4,5	3,4	00153040	00152041	00152042	00152043
BSW 3/16	24	3,8	50	16	6,0	4,9	00153050	00152051	00152052	00152053
BSW 7/32	24	4,6	56	17	6,0	4,9	00153060	00152061	00152062	00152063
BSW 1/4	20	5,1	56	19	6,0	4,9	00153070	00152071	00152072	00152073
BSW 5/16	18	6,5	63	22	6,0	4,9	00153080	00152081	00152082	00152083
BSW 3/8	16	7,9	70	24	7,0	5,5	00153090	00152091	00152092	00152093
BSW 7/16	14	9,3	70	24	8,0	6,2	00153100	00152101	00152102	00152103
BSW 1/2	12	10,5	75	28	9,0	7,0	00153110	00152111	00152112	00152113
BSW 9/16	12	12,0	80	30	11,0	9,0	00153120	00152121	00152122	00152123
BSW 5/8	11	13,5	80	32	12,0	9,0	00153130	00152131	00152132	00152133
BSW 3/4	10	16,5	95	34	14,0	11,0	00153140	00152141	00152142	00152143
BSW 7/8	9	19,5	100	34	18,0	14,5	00153150	00152151	00152152	00152153
BSW 1	8	22,0	110	38	18,0	14,5	00153160	00152161	00152162	00152163
BSW 1.1/8	7	25,0	125	45	22,0	18,0	00153170	00152171	00152172	00152173
BSW 1.1/4	7	28,0	125	45	22,0	18,0	00153180	00152181	00152182	00152183
BSW 1.3/8	6	30,5	150	56	28,0	22,0	00153190	00152191	00152192	00152193
BSW 1.1/2	6	33,5	150	56	28,0	22,0	00153200	00152201	00152202	00152203
BSW 1.5/8	5	35,5	150	60	32,0	24,0	00153210	00152211	00152212	00152213
BSW 1.3/4	5	39	160	65	36,0	29,0	00153220	00152321	00152322	00152323
BSW 1.7/8	4,5	41,5	180	70	36,0	29,0	00153230	00152231	00152232	00152233
BSW 2	4,5	44,5	180	70	40,0	32,0	00153240	00152241	00152242	00152243
BSW 2.1/4	4	50,8	200	75	45,0	35,0	00153250	00152251	00152252	00152253
BSW 2.1/2	4	57,15	220	80	50,0	39,0	00153260	00152261	00152262	00152263
BSW 2.3/4	3,5	62,6	240	80	50,0	39,0	00153270	00152271	00152272	00152273
BSW 3	3,5	68,95	260	85	50,0	39,0	00153280	00152281	00152282	00152283

РУЧНОЙ МЕТЧИК LH

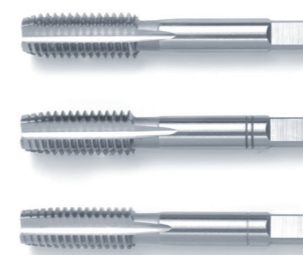

ТЕХНИЧЕСКАЯ ИНФОРМАЦИЯ

Норма	ISO 529	Обр. Материал	Сталь
Резьба	BSW	Вид отверстия	Сквозное / глухое
Материал	HSS-G	Направление	левый

↙	↘	↘	↙	↘	↙	◇	Набор	Нр. 1	Нр. 2	Нр. 3
BSW 1/8	40	2,6	48	11	3,15	2,5	00129030	00127031	00127032	00127033
BSW 5/32	32	3,2	55	13	4,5	3,55	00129040	00127041	00127042	00127043
BSW 3/16	24	3,8	58	16	5,0	4,0	00129050	00127051	00127052	00127053
BSW 1/4	20	5,1	66	19	6,3	5,0	00129070	00127071	00127072	00127073
BSW 5/16	18	6,5	72	22	8,0	6,3	00129080	00127081	00127082	00127083
BSW 3/8	16	7,9	80	24	10,0	8,0	00129090	00127091	00127092	00127093
BSW 7/16	14	9,3	85	25	8,0	6,3	00129100	00127101	00127102	00127103
BSW 1/2	12	10,5	89	29	9,0	7,1	00129110	00127111	00127112	00127113
BSW 9/16	12	12,0	95	30	11,2	9,0	00129120	00127121	00127122	00127123
BSW 5/8	11	13,5	102	32	12,5	10,0	00129130	00127131	00127132	00127133
BSW 3/4	10	16,5	112	37	14,0	11,2	00129140	00127141	00127142	00127143
BSW 7/8	9	19,5	118	38	16,0	12,5	00129150	00127151	00127152	00127153
BSW 1	8	22,0	130	45	18,0	14,0	00129160	00127161	00127162	00127163
BSW 1.1/8	7	25,0	138	48	20,0	16,0	00129170	00127171	00127172	00127173
BSW 1.1/4	7	28,0	151	51	22,4	18,0	00129180	00127181	00127182	00127183
BSW 1.3/8	6	30,5	162	57	25,0	20,0	00129190	00127191	00127192	00127193
BSW 1.1/2	6	33,5	170	60	28,0	22,4	00129200	00127201	00127202	00127203
BSW 1.3/4	5	39,0	187	67	31,5	25,0	00129220	00127221	00127222	00127223
BSW 2	4,5	44,5	200	70	35,5	28,0	00129240	00127241	00127242	00127243

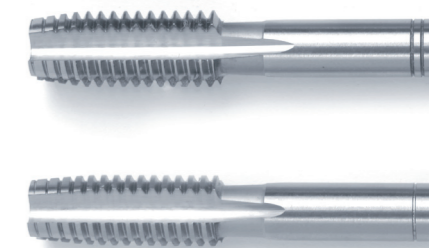



▶ РУЧНОЙ МЕТЧИК

DIN 5157



Двухпроходный набор для трубной внутренней резьбы – для неплотных соединений (G) по DIN ISO 228 часть 1 – состоит из черного и чистового метчиков. Размеры G 1/4 до G 4" изготавливаются с проходным хвостовиком и четырьмя канавками. Шаг резьбы обозначается как нитки на дюйм.



ЧЕТЫРЁХГРАННИК ПО DIN 10 для закрепления метчиков в воротке (vW).

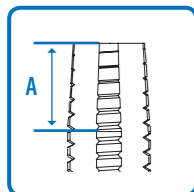

ПЕРВЫЙ (ЧЕРНОВОЙ МЕТЧИК)

Маркирован одним кольцом, длинная заборная часть, Форма A / 6-8 витков

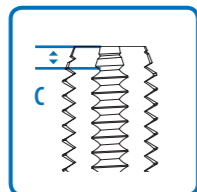

ТРЕТИЙ (ЧИСТОВОЙ)

Без маркировки, короткая заборная часть, Форма C / 2-3 витка

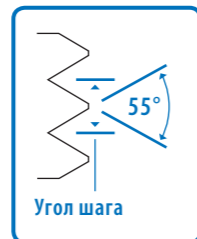

РЕЗЬБА С ТРУБНЫМ ПРОФИЛЕМ

**МЕТЧИК
DIN 5157 · 2S · G 1/2 · 6H · HSS**

- Обозначение**
- DIN 5157 = Немецкий институт по стандартизации
 - 2S = Набор метчиков 2-шт.
 - G 1/2 = Трубная резьба Витворта по DIN ISO 228 1/2 дюйма (=25,4 мм)
 - 6H = класс точности по DIN 802, часть 1
 - HSS = быстрорежущая сталь группы сплавов HSS
- Маркировка в соответствии с DIN 2197**
G 1/2 6H HSS

Трубные резьбы Витворта имеют профиль резьбы 55° по сравнению с метрическими резьбами с углом в профиле 60°. Различают между цилиндрической и конической резьбами Витворта. Коническая резьба по DIN EN 10226-1 (старое обозначение DIN 2999) является самогерметизирующей (R).

Причина в том, что диаметр конической резьбы после нескольких оборотов полностью соответствует противоположной резьбе. При дальнейшем вкручивании резьбы как бы впиваются друг в друга и таким образом они плотно самогерметизируются. Цилиндрическая резьба по DIN ISO 228 не является самогерметизирующей. (обозначение = G).



РУЧНОЙ МЕТЧИК



ТЕХНИЧЕСКАЯ ИНФОРМАЦИЯ

Норма	DIN 5157	Обр. Материал	Сталь
Резьба	BSP	Вид отверстия	Сквозное / глухое
Материал	HSS-G	Направление	правый
		Класс точности	6h

Символы	Набор	Нр. 1	Нр. 2
BSP 1/8	28	8,8	63 20 7,0 5,5 00155020 00154021 00154023
BSP 1/4	19	11,8	70 22 11,0 9,0 00155060 00154061 00154063
BSP 3/8	19	15,3	70 22 12,0 9,0 00155080 00154081 00154083
BSP 1/2	14	19,0	80 22 16,0 12,0 00155100 00154101 00154103
BSP 5/8	14	21,0	80 22 18,0 14,5 00155120 00154121 00154123
BSP 3/4	14	24,5	90 22 20,0 16,0 00155130 00154131 00154133
BSP 7/8	14	28,3	90 22 22,0 18,0 00155140 00154141 00154143
BSP 1	11	30,5	100 25 25,0 20,0 00155150 00154151 00154153
BSP 1.1/8	11	35,5	125 40 28,0 22,0 00155170 00154171 00154173
BSP 1.1/4	11	39,5	125 40 32,0 24,0 00155180 00154181 00154183
BSP 1.3/8	11	42,0	125 40 36,0 29,0 00155190 00154191 00154193
BSP 1.1/2	11	45,0	140 40 36,0 29,0 00155200 00154201 00154203
BSP 1.5/8	11	49,6	140 40 36,0 29,0 00155210 00154211 00154213
BSP 1.3/4	11	51,0	140 40 40,0 32,0 00155220 00154221 00154223
BSP 2	11	57,0	160 40 45,0 35,0 00155230 00154231 00154233
BSP 2.1/4	11	63,3	160 40 50,0 39,0 00155240 00154241 00154243
BSP 2.1/2	11	72,8	160 40 50,0 39,0 00155250 00154251 00154253
BSP 2.3/4	11	79,0	160 40 50,0 39,0 00155260 00154261 00154263
BSP 3	11	85,5	160 40 50,0 39,0 00155270 00154271 00154273
BSP 3.1/4	11	91,6	180 45 56,0 44,0 00155280 00154281 00154283
BSP 3.1/2	11	98,0	180 45 63,0 49,0 00155290 00154291 00154293
BSP 3.3/4	11	104,0	180 45 70,0 55,0 00155300 00154301 00154303
BSP 4	11	110,7	180 45 70,0 55,0 00155310 00154311 00154313

РУЧНОЙ МЕТЧИК



ТЕХНИЧЕСКАЯ ИНФОРМАЦИЯ

Норма	DIN 5157	Обр. Материал	Сталь
Резьба	BSP	Вид отверстия	Сквозное / глухое
Материал	HSSE-G	Направление	правый
		Класс точности	6h

Символы	Набор	Нр. 1	Нр. 2
BSP 1/8	28	8,8	63 20 7,0 5,5 00159020 00158021 00158023
BSP 1/4	19	11,8	70 22 11,0 9,0 00159060 00158061 00158063
BSP 3/8	19	15,3	70 22 12,0 9,0 00159080 00158081 00158083
BSP 1/2	14	19,0	80 22 16,0 12,0 00159100 00158101 00158103
BSP 5/8	14	21,0	80 22 18,0 14,5 00159120 00158121 00158123
BSP 3/4	14	24,5	90 22 20,0 16,0 00159130 00158131 00158133
BSP 7/8	14	28,3	90 22 22,0 18,0 00159140 00158141 00158143
BSP 1	11	30,5	100 25 25,0 20,0 00159150 00158151 00158153
BSP 1.1/8	11	35,5	125 40 28,0 22,0 00159170 00158171 00158173
BSP 1.1/4	11	39,5	125 40 32,0 24,0 00159180 00158181 00158183
BSP 1.3/8	11	42,0	125 40 36,0 29,0 00159190 00158191 00158193
BSP 1.1/2	11	45,0	140 40 36,0 29,0 00159200 00158201 00158203
BSP 1.5/8	11	49,6	140 40 36,0 29,0 00159210 00158211 00158213
BSP 1.3/4	11	51,0	140 40 40,0 32,0 00159220 00158221 00158223
BSP 2	11	57,0	160 40 45,0 35,0 00159230 00158231 00158233
BSP 2.1/4	11	63,3	160 40 50,0 39,0 00159240 00158241 00158243
BSP 2.1/2	11	72,8	160 40 50,0 39,0 00159250 00158251 00158253
BSP 2.3/4	11	79,0	160 40 50,0 39,0 00159260 00158261 00158263
BSP 3	11	85,5	160 40 50,0 39,0 00159270 00158271 00158273

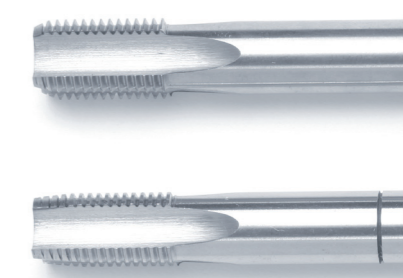

РУЧНОЙ МЕТЧИК LH

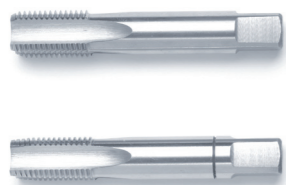

ТЕХНИЧЕСКАЯ ИНФОРМАЦИЯ

Норма	DIN 5157	Обр. Материал	Сталь
Резьба	BSP	Вид отверстия	Сквозное / глухое
Материал	HSS-G	Направление	левый
		Класс точности	6h

							Набор	Нр. 1	Нр. 2
BSP 1/8	28	8,8	63	20	7,0	5,5	00157020	00156021	00156023
BSP 1/4	19	11,8	70	22	11,0	9,0	00157060	00156061	00156063
BSP 3/8	19	15,3	70	22	12,0	9,0	00157080	00156081	00156083
BSP 1/2	14	19,0	80	22	16,0	12,0	00157100	00156101	00156103
BSP 5/8	14	21,0	80	22	18,0	14,5	00157120	00156121	00156123
BSP 3/4	14	24,5	90	22	20,0	16,0	00157130	00156131	00156133
BSP 7/8	14	28,3	90	22	22,0	18,0	00157140	00156141	00156143
BSP 1	11	30,5	100	25	25,0	20,0	00157150	00156151	00156153
BSP 1.1/8	11	35,5	125	40	28,0	22,0	00157170	00156171	00156173
BSP 1.1/4	11	39,5	125	40	32,0	24,0	00157180	00156181	00156183
BSP 1.3/8	11	42,0	125	40	36,0	29,0	00157190	00156191	00156193
BSP 1.1/2	11	45,0	140	40	36,0	29,0	00157200	00156201	00156203
BSP 1.5/8	11	49,6	140	40	36,0	29,0	00157210	00156211	00156213
BSP 1.3/4	11	51,0	140	40	40,0	32,0	00157220	00156221	00156223
BSP 2	11	57,0	160	40	45,0	35,0	00157230	00156231	00156233
BSP 2.1/4	11	63,3	160	40	50,0	39,0	00157240	00156241	00156243
BSP 2.1/2	11	72,8	160	40	50,0	39,0	00157250	00156251	00156253
BSP 2.3/4	11	79,0	160	40	50,0	39,0	00157260	00156261	00156263
BSP 3	11	85,5	160	40	50,0	39,0	00157270	00156271	00156273

РУЧНОЙ МЕТЧИК

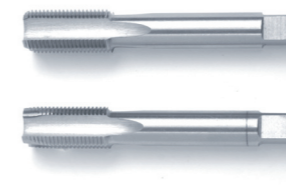

ТЕХНИЧЕСКАЯ ИНФОРМАЦИЯ

Норма	DIN 2184-2 (~ DIN 352)
Резьба	BSF
Материал	HSS-G
Обр. Материал	Сталь
Вид отверстия	Сквозное / глухое
Направление	правый

							Набор	Нр. 1	Нр. 2
BSF 3/16	32	4,0	45	14	5,5	4,3	00145040	00144041	00144043
BSF 1/4	26	5,3	50	16	6,0	4,9	00145060	00144061	00144063
BSF 5/16	22	6,8	56	18	6,0	4,9	00145070	00144071	00144073
BSF 3/8	20	8,3	56	18	7,0	5,5	00145080	00144081	00144083
BSF 7/16	18	9,7	63	22	8,0	6,2	00145090	00144091	00144093
BSF 1/2	16	11,1	70	22	9,0	7,0	00145100	00144101	00144103
BSF 9/16	16	12,7	70	25	11,0	9,0	00145110	00144111	00144113
BSF 5/8	14	14,0	70	25	12,0	9,0	00145120	00144121	00144123
BSF 11/16	14	15,7	80	28	14,0	11,0	00145130	00144131	00144133
BSF 3/4	12	16,8	80	28	14,0	11,0	00145140	00144141	00144143
BSF 13/16	12	18,5	90	28	16,0	12,0	00145150	00144151	00144153
BSF 7/8	11	19,8	90	28	18,0	14,5	00145160	00144161	00144163
BSF 15/16	11	21,5	90	32	18,0	14,5	00145170	00144171	00144173
BSF 1	10	22,8	100	32	20,0	16,0	00145180	00144181	00144183
BSF 1.1/8	9	25,5	110	40	20,0	16,0	00145200	00144201	00144203
BSF 1.1/4	9	28,6	125	46	22,0	18,0	00145210	00144211	00144213
BSF 1.3/8	8	31,5	125	46	25,0	20,0	00145220	00144221	00144223
BSF 1.1/2	8	34,6	150	55	28,0	22,0	00145230	00144231	00144233
BSF 1.5/8	8	38,1	140	45	32,0	24,0	00145240	00144241	00144243
BSF 1.3/4	7	40,8	150	50	36,0	29,0	00145250	00144251	00144253
BSF 2	7	47,2	150	50	40,0	32,0	00145260	00144261	00144263

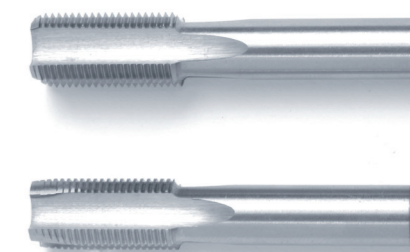

РУЧНОЙ МЕТЧИК

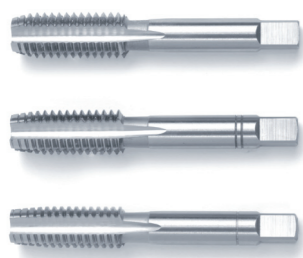

ТЕХНИЧЕСКАЯ ИНФОРМАЦИЯ

Норма	DIN 2184-2 (~ DIN 352)
Резьба	UNC
Материал	HSS-G
Обр. Материал	Сталь
Вид отверстия	Сквозное / глухое
Направление	правый
Класс точности	2b

	W	M	M	M	W	◇	Набор	Нр. 1	Нр. 2	Нр. 3
UNC Нр. 1	64	1,5	36	8	2,8	2,1	00165010	00164011	00164012	00164013
UNC Нр. 2	56	1,8	36	9	2,8	2,1	00165020	00164021	00164022	00164023
UNC Нр. 3	48	2,1	40	9	2,8	2,1	00165030	00164031	00164032	00164033
UNC Нр. 4	40	2,3	40	11	3,5	2,7	00165040	00164041	00164042	00164043
UNC Нр. 5	40	2,6	40	11	3,5	2,7	00165050	00164051	00164052	00164053
UNC Нр. 6	32	2,9	45	12	4	3	00165060	00164061	00164062	00164063
UNC Нр. 8	32	3,5	45	13	4,5	3,4	00165080	00164081	00164082	00164083
UNC Нр. 10	24	3,9	50	16	6	4,9	00165100	00164101	00164102	00164103
UNC Нр. 12	24	4,5	56	17	6	4,9	00165120	00164121	00164122	00164123
UNC 1/4	20	5,2	56	19	6	4,9	00165130	00164131	00164132	00164133
UNC 5/16	18	6,6	63	22	6	4,9	00165140	00164141	00164142	00164143
UNC 3/8	16	8	70	24	7	5,5	00165150	00164151	00164152	00164153
UNC 7/16	14	9,4	70	24	8	6,2	00165160	00164161	00164162	00164163
UNC 1/2	13	10,8	75	28	9	7	00165170	00164171	00164172	00164173
UNC 9/16	12	12,3	80	30	11	9	00165180	00164181	00164182	00164183
UNC 5/8	11	13,5	80	32	12	9	00165190	00164191	00164192	00164193
UNC 3/4	10	16,5	95	34	14	11	00165210	00164211	00164212	00164213
UNC 7/8	9	19,5	100	34	18	14,5	00165230	00164231	00164232	00164233
UNC 1	8	22,3	110	38	18	14,5	00165250	00164251	00164252	00164253
UNC 1.1/8	7	25	125	45	22	18	00165260	00164261	00164262	00164263
UNC 1.1/4	7	28,3	125	45	22	18	00165270	00164271	00164272	00164273
UNC 1.3/8	6	30,8	150	56	28	22	00165280	00164281	00164282	00164283
UNC 1.1/2	6	34	150	56	28	22	00165290	00164291	00164292	00164293
UNC 1.5/8	5	37,1	150	60	32	24	00165300	00164301	00164302	00164303
UNC 1.3/4	5	39,5	160	65	36	29	00165310	00164311	00164312	00164313
UNC 1.7/8	4,5	42	180	70	36	29	00165320	00164321	00164322	00164323
UNC 2	4,5	45	180	70	40	32	00165330	00164331	00164332	00164333
UNC 2.1/4	4,5	51,5	200	75	45	35	00165340	00164341	00164342	00164343
UNC 2.1/2	4	57,2	220	80	50	39	00165350	00164351	00164352	00164353
UNC 2.3/4	4	63,25	240	80	50	39	00165360	00164361	00164362	00164363
UNC 3	4	69,85	260	85	50	39	00165370	00164371	00164372	00164373

РУЧНОЙ МЕТЧИК

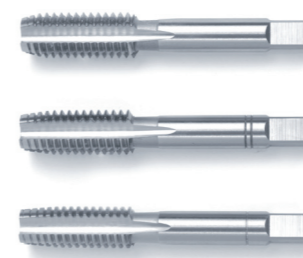

ТЕХНИЧЕСКАЯ ИНФОРМАЦИЯ

Норма	ISO 529	Обр. Материал	Сталь
Резьба	UNC	Вид отверстия	Сквозное / глухое
Материал	HSS-G	Направление	правый
		Класс точности	2b

	W	M	M	M	W	◇	Набор	Нр. 1	Нр. 2	Нр. 3
UNC Нр. 1	64	1,5	32	7	2,5	2,1	00163010	00162011	00162012	00162013
UNC Нр. 2	56	1,8	36	8	2,8	2,1	00163020	00162021	00162022	00162023
UNC Нр. 3	48	2,1	45	10	2,8	2,24	00163030	00162031	00162032	00162033
UNC Нр. 4	40	2,3	48	15	3,15	2,5	00163040	00162041	00162042	00162043
UNC Нр. 5	40	2,6	48	15	3,15	2,5	00163050	00162051	00162052	00162053
UNC Нр. 6	32	2,9	50	17	3,55	2,8	00163060	00162061	00162062	00162063
UNC Нр. 8	32	3,5	53	13	4,5	3,55	00163080	00162081	00162082	00162083
UNC Нр. 10	24	3,9	58	16	5	4	00163100	00162101	00162102	00162103
UNC Нр. 12	24	4,5	62	17	5,6	4,5	00163120	00162121	00162122	00162123
UNC 1/4	20	5,2	66	19	6,3	5,0	00163130	00162131	00162132	00162133
UNC 5/16	18	6,6	72	22	8,0	6,3	00163140	00162141	00162142	00162143
UNC 3/8	16	8	80	24	10,0	8,0	00163150	00162151	00162152	00162153
UNC 7/16	14	9,4	85	25	8,0	6,3	00163160	00162161	00162162	00162163
UNC 1/2	13	10,8	89	29	9,0	7,1	00163170	00162171	00162172	00162173
UNC 9/16	12	12,3	95	30	11,2	9,0	00163180	00162181	00162182	00162183
UNC 5/8	11	13,5	102	32	12,5	10,0	00163190	00162191	00162192	00162193
UNC 3/4	10	16,5	112	37	14,0	11,2	00163210	00162211	00162212	00162213
UNC 7/8	9	19,5	118	38	16,0	12,5	00163230	00162231	00162232	00162233
UNC 1	8	22,3	130	45	18,0	14,0	00163250	00162251	00162252	00162253
UNC 1.1/8	7	25	138	48	20	16	00163260	00162261	00162262	00162263
UNC 1.1/4	7	28,3	151	51	22,4	18	00163270	00162271	00162272	00162273
UNC 1.1/2	6	34	170	60	28	22,4	00163290	00162291	00162292	00162293
UNC 1.3/4	5	39,5	187	67	31,5	25	00163310	00162311	00162312	00162313
UNC 2	4,5	45	200	70	35,5	28	00163330	00162331	00162332	00162333

РУЧНОЙ МЕТЧИК LH

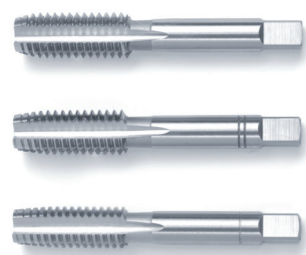

ТЕХНИЧЕСКАЯ ИНФОРМАЦИЯ

Норма	DIN 2184-2 (~ DIN 352)
Резьба	UNC
Материал	HSS-G
Обр. Материал	Сталь
Вид отверстия	Сквозное / глухое
Направление	левый
Класс точности	2b

							Набор	Нр. 1	Нр. 2	Нр. 3
UNC Нр. 1	64	1,5	36	8	2,8	2,1	00811010	00810011	00810012	00810013
UNC Нр. 2	56	1,8	36	9	2,8	2,1	00811020	00810021	00810022	00810023
UNC Нр. 3	48	2,1	40	9	2,8	2,1	00811030	00810031	00810032	00810033
UNC Нр. 4	40	2,3	40	11	3,5	2,7	00811040	00810041	00810042	00810043
UNC Нр. 5	40	2,6	40	11	3,5	2,7	00811050	00810051	00810052	00810053
UNC Нр. 6	32	2,9	45	12	4	3	00811060	00810061	00810062	00810063
UNC Нр. 8	32	3,5	45	13	4,5	3,4	00811080	00810081	00810082	00810083
UNC Нр. 10	24	3,9	50	16	6	4,9	00811100	00810101	00810102	00810103
UNC Нр. 12	24	4,5	56	17	6	4,9	00811120	00810121	00810122	00810123
UNC 1/4	20	5,2	56	19	6	4,9	00811130	00810131	00810132	00810133
UNC 5/16	18	6,6	63	22	6	4,9	00811140	00810141	00810142	00810143
UNC 3/8	16	8	70	24	7	5,5	00811150	00810151	00810152	00810153
UNC 7/16	14	9,4	70	24	8	6,2	00811160	00810161	00810162	00810163
UNC 1/2	13	10,8	75	28	9	7	00811170	00810171	00810172	00810173
UNC 9/16	12	12,3	80	30	11	9	00811180	00810181	00810182	00810183
UNC 5/8	11	13,5	80	32	12	9	00811190	00810191	00810192	00810193
UNC 3/4	10	16,5	95	34	14	11	00811210	00810211	00810212	00810213
UNC 7/8	9	19,5	100	34	18	14,5	00811230	00810231	00810232	00810233
UNC 1	8	22,3	110	38	18	14,5	00811250	00810251	00810252	00810253

РУЧНОЙ МЕТЧИК



ТЕХНИЧЕСКАЯ ИНФОРМАЦИЯ

Норма	ISO 529	Обр. Материал	Сталь
Резьба	UNC	Вид отверстия	Сквозное / глухое
Материал	HSS-G	Направление	левый
		Класс точности	2b

							Набор	Нр. 1	Нр. 2	Нр. 3
UNC Нр. 1	64	1,5	32	7	2,5	2,1	00169010	00168011	00168012	00168013
UNC Нр. 2	56	1,8	36	8	2,8	2,1	00169020	00168021	00168022	00168023
UNC Нр. 3	48	2,1	45	10	2,8	2,24	00169030	00168031	00168032	00168033
UNC Нр. 4	40	2,3	48	15	3,15	2,5	00169040	00168041	00168042	00168043
UNC Нр. 5	40	2,6	48	15	3,15	2,5	00169050	00168051	00168052	00168053
UNC Нр. 6	32	2,9	50	17	3,55	2,8	00169060	00168061	00168062	00168063
UNC Нр. 8	32	3,5	53	13	4,5	3,55	00169080	00168081	00168082	00168083
UNC Нр. 10	24	3,9	58	16	5	4	00169100	00168101	00168102	00168103
UNC Нр. 12	24	4,5	62	17	5,6	4,5	00169120	00168121	00168122	00168123
UNC 1/4	20	5,2	66	19	6,3	5,0	00169130	00168131	00168132	00168133
UNC 5/16	18	6,6	72	22	8,0	6,3	00169140	00168141	00168142	00168143
UNC 3/8	16	8	80	24	10,0	8,0	00169150	00168151	00168152	00168153
UNC 7/16	14	9,4	85	25	8,0	6,3	00169160	00168161	00168162	00168163
UNC 1/2	13	10,8	89	29	9,0	7,1	00169170	00168171	00168172	00168173
UNC 9/16	12	12,3	95	30	11,2	9,0	00169180	00168181	00168182	00168183
UNC 5/8	11	13,5	102	32	12,5	10,0	00169190	00168191	00168192	00168193
UNC 3/4	10	16,5	112	37	14,0	11,2	00169210	00168211	00168212	00168213
UNC 7/8	9	19,5	118	38	16,0	12,5	00169230	00168231	00168232	00168233
UNC 1	8	22,3	130	45	18,0	14,0	00169250	00168251	00168252	00168253

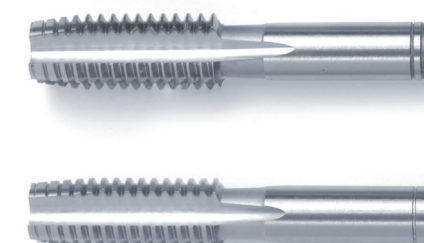

РУЧНОЙ МЕТЧИК

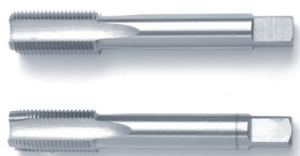

ТЕХНИЧЕСКАЯ ИНФОРМАЦИЯ

Норма	DIN 2184-2 (~ DIN 352)
Резьба	UNF
Материал	HSS-G
Обр. Материал	Сталь
Вид отверстия	Сквозное / глухое
Направление	правый
Класс точности	2b

РУЧНОЙ МЕТЧИК

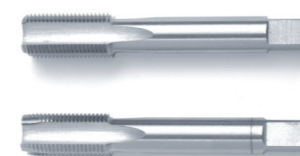

ТЕХНИЧЕСКАЯ ИНФОРМАЦИЯ

Норма	ISO 529	Обр. Материал	Сталь
Резьба	UNF	Вид отверстия	Сквозное / глухое
Материал	HSS-G	Направление	правый
		Класс точности	2b

Символ	Символ	Символ	Символ	Символ	Символ	Символ	Набор	Нр. 1	Нр. 2
UNF Нр. 0	80	1,25	32	8	2,5	2,1	00175000	00174001	00174003
UNF Нр. 1	72	1,55	36	8	2,8	2,1	00175010	00174011	00174013
UNF Нр. 2	64	1,85	36	9	2,8	2,1	00175020	00174021	00174023
UNF Нр. 3	56	2,1	40	9	2,8	2,1	00175030	00174031	00174033
UNF Нр. 4	48	2,4	40	11	3,5	2,7	00175040	00174041	00174043
UNF Нр. 5	44	2,7	40	11	3,5	2,7	00175050	00174051	00174053
UNF Нр. 6	40	3,0	45	12	4,0	3,0	00175060	00174061	00174063
UNF Нр. 8	36	3,5	45	13	4,5	3,4	00175080	00174081	00174083
UNF Нр. 10	32	4,1	50	16	6,0	4,9	00175100	00174101	00174103
UNF Нр. 12	28	4,65	56	17	6,0	4,9	00175120	00174121	00174123
UNF 1/4	28	5,5	56	19	6,0	4,9	00175130	00174131	00174133
UNF 5/16	24	6,9	63	22	6,0	4,9	00175140	00174141	00174143
UNF 3/8	24	8,5	63	20	7,0	5,5	00175150	00174151	00174153
UNF 7/16	20	9,9	70	24	8,0	6,2	00175160	00174161	00174163
UNF 1/2	20	11,5	70	22	9,0	7,0	00175170	00174171	00174173
UNF 9/16	18	13,0	70	22	11,0	9,0	00175180	00174181	00174183
UNF 5/8	18	14,5	70	22	12,0	9,0	00175190	00174191	00174193
UNF 3/4	16	17,5	80	22	14,0	11,0	00175210	00174211	00174213
UNF 7/8	14	20,5	80	22	18,0	14,5	00175230	00174231	00174233
UNF 1 (14)	14	23,3	90	22	18,0	14,5	00175250	00174251	00174253
UNF 1 (12)	12	23,3	90	22	18,0	14,5	00175260	00174261	00174263
UNF 1.1/8	12	26,5	90	22	22,0	18,0	00175270	00174271	00174273
UNF 1.1/4	12	29,5	90	22	22,0	18,0	00175280	00174281	00174283
UNF 1.3/8	12	32,5	125	40	28,0	22,0	00175290	00174291	00174293
UNF 1.1/2	12	36,0	125	40	28,0	22,0	00175300	00174301	00174303

Символ	Символ	Символ	Символ	Символ	Символ	Символ	Набор	Нр. 1	Нр. 2
UNF Нр. 1	72	1,55	41	8	—	2	00173040	00172041	00172043
UNF Нр. 2	64	1,85	44,5	9,5	—	2,24	00173050	00172051	00172053
UNF Нр. 3	56	2,1	44,5	9,5	—	2,24	00173060	00172061	00172063
UNF Нр. 4	48	2,4	48	11	2,12	2,5	00173040	00172041	00172043
UNF Нр. 5	44	2,7	48	11	2,36	2,5	00173050	00172051	00172053
UNF Нр. 6	40	3	50	13	2,5	2,8	00173060	00172061	00172063
UNF Нр. 8	36	3,5	53	13	3,15	3,55	00173080	00172081	00172083
UNF Нр. 10	32	4,1	58	16	3,55	4	00173100	00172101	00172103
UNF Нр. 12	28	4,65	62	17	4,25	4,5	00173120	00172121	00172123
UNF 1/4	28	5,5	66	19	6,3	5,0	00173130	00172131	00172133
UNF 5/16	24	6,9	69	19	8,0	6,3	00173140	00172141	00172143
UNF 3/8	24	8,5	76	20	10,0	8,0	00173150	00172151	00172153
UNF 7/16	20	9,9	82	22	8,0	6,3	00173160	00172161	00172163
UNF 1/2	20	11,5	84	24	9,0	7,1	00173170	00172171	00172173
UNF 9/16	18	13,0	90	25	11,2	9,0	00173180	00172181	00172183
UNF 5/8	18	14,5	95	25	12,5	10,0	00173190	00172191	00172193
UNF 3/4	16	17,5	104	29	14,0	11,2	00173210	00172211	00172213
UNF 7/8	14	20,5	113	33	16,0	12,5	00173230	00172231	00172233
UNF 1 (14)	14	23,3	120	35	18,0	14,0	00173250	00172251	00172253
UNF 1 (12)	12	23,3	120	35	18,0	14,0	00173260	00172261	00172263
UNF 1.1/8	12	26,5	127	37	20,0	16,0	00173270	00172271	00172273
UNF 1.1/4	12	29,5	137	37	22,4	18,0	00173280	00172281	00172283
UNF 1.3/8	12	32,5	144	39	25,0	20,0	00173290	00172291	00172293
UNF 1.1/2	12	36,0	149	39	28,0	22,4	00173300	00172301	00172303

РУЧНОЙ МЕТЧИК

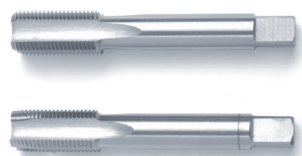

ТЕХНИЧЕСКАЯ ИНФОРМАЦИЯ

Норма	DIN 2184-2	Обр. Материал	Сталь
Резьба	UNEF	Вид отверстия	Сквозное / глухое
Материал	HSS-G	Направление	правый
		Класс точности	2b

РУЧНОЙ МЕТЧИК

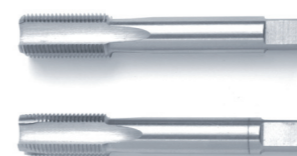

ТЕХНИЧЕСКАЯ ИНФОРМАЦИЯ

Норма	ISO 529	Обр. Материал	Сталь
Резьба	UNEF	Вид отверстия	Сквозное / глухое
Материал	HSS-G	Направление	правый
		Класс точности	2b

Иконка	М	М	М	М	Иконка	◇	Набор	Нр. 1	Нр. 2
UNEF Нр. 12	32	4,7	56	17	6	4,9	00177010	00176011	00176013
UNEF 1/4	32	5,55	56	14	6,0	4,9	00177020	00176021	00176023
UNEF 5/16	32	7,15	56	18	6,0	4,9	00177030	00176031	00176033
UNEF 3/8	32	8,75	63	20	7,0	5,5	00177040	00176041	00176043
UNEF 7/16	28	10,2	63	20	8,0	6,2	00177050	00176051	00176053
UNEF 1/2	28	11,8	70	22	9,0	7,0	00177060	00176061	00176063
UNEF 9/16	24	13,2	70	22	11,0	9,0	00177070	00176071	00176073
UNEF 5/8	24	14,8	70	22	12,0	9,0	00177080	00176081	00176083
UNEF 11/16	24	16,4	80	22	14,0	11,0	00177090	00176091	00176093
UNEF 3/4	20	17,8	80	22	14,0	11,0	00177100	00176101	00176103
UNEF 13/16	20	19,4	80	22	16,0	12,0	00177110	00176111	00176113
UNEF 7/8	20	21	80	22	18,0	14,5	00177120	00176121	00176123
UNEF 15/16	20	22,5	90	22	18,0	14,5	00177130	00176131	00176133
UNEF 1	20	24,1	90	22	18,0	14,5	00177140	00176141	00176143
UNEF 1.1/16	18	25,6	90	22	20,0	16,0	00177150	00176151	00176153
UNEF 1.1/8	18	27,2	90	22	22,0	18,0	00177160	00176161	00176163
UNEF 1.3/16	18	28,8	90	22	22,0	18,0	00177170	00176171	00176173
UNEF 1.1/4	18	30,3	90	22	22,0	18,0	00177180	00176181	00176183
UNEF 1.5/16	18	31,9	100	25	28,0	22,0	00177190	00176191	00176193
UNEF 1.3/8	18	33,5	100	25	28,0	22,0	00177200	00176201	00176203
UNEF 1.7/16	18	35,1	100	25	28,0	22,0	00177210	00176211	00176213
UNEF 1.1/2	18	36,7	100	25	28,0	22,0	00177220	00176221	00176223
UNEF 1.9/16	18	38,3	100	25	32,0	24,0	00177230	00176231	00176233
UNEF 1.5/8	18	39,9	100	25	32,0	24,0	00177240	00176241	00176243
UNEF 1.11/16	18	41,5	100	25	36,0	29,0	00177250	00176251	00176253

Иконка	М	М	М	М	Иконка	◇	Набор	Нр. 1	Нр. 2
UNEF Нр. 12	32	4,7	48	16	6,0	4,9	00179010	00178011	00178013
UNEF 1/4	32	5,55	48	16	6,0	4,9	00179020	00178021	00178023
UNEF 5/16	32	7,15	56	16	6,0	4,9	00179030	00178031	00178033
UNEF 3/8	32	8,75	63	18	7,0	5,5	00179040	00178041	00178043
UNEF 7/16	28	10,2	63	18	9,0	7,0	00179050	00178051	00178053
UNEF 1/2	28	11,8	70	20	9,0	7,0	00179060	00178061	00178063
UNEF 9/16	24	13,2	70	20	11,0	9,0	00179070	00178071	00178073
UNEF 5/8	24	14,8	70	20	12,0	9,0	00179080	00178081	00178083
UNEF 11/16	24	16,4	80	22	14,0	11,0	00179090	00178091	00178093
UNEF 3/4	20	17,8	80	22	14,0	11,0	00179100	00178101	00178103
UNEF 13/16	20	19,4	80	22	16,0	12,0	00179110	00178111	00178113
UNEF 7/8	20	21	80	22	18,0	14,5	00179120	00178121	00178123
UNEF 15/16	20	22,5	80	22	18,0	14,5	00179130	00178131	00178133
UNEF 1	20	24,1	90	22	20,0	16,0	00179140	00178141	00178143
UNEF 1.1/16	18	25,6	90	22	20,0	16,0	00179150	00178151	00178153
UNEF 1.1/8	18	27,2	90	22	22,0	18,0	00179160	00178161	00178163
UNEF 1.3/16	18	28,8	90	22	22,0	18,0	00179170	00178171	00178173
UNEF 1.1/4	18	30,3	90	22	25,0	20,0	00179180	00178181	00178183
UNEF 1.5/16	18	31,9	90	22	25,0	20,0	00179190	00178191	00178193
UNEF 1.3/8	18	33,5	100	25	28,0	22,0	00179200	00178201	00178203
UNEF 1.7/16	18	35,1	110	25	28,0	22,0	00179210	00178211	00178213
UNEF 1.1/2	18	36,7	110	25	32,0	24,0	00179220	00178221	00178223
UNEF 1.9/16	18	38,3	110	25	32,0	24,0	00179230	00178231	00178233
UNEF 1.5/8	18	39,9	110	25	32,0	24,0	00179240	00178241	00178243
UNEF 1.11/16	18	41,5	110	25	32,0	24,0	00179250	00178251	00178253

РУЧНОЙ МЕТЧИК

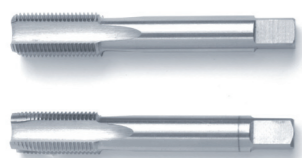

ТЕХНИЧЕСКАЯ ИНФОРМАЦИЯ

Норма	DIN 2184-2 (~ DIN 352)
Резьба	UN / UNS
Материал	HSS-G
Обр. Материал	Сталь
Вид отверстия	Сквозное / глухое
Направление	правый
Класс точности	2b

РУЧНОЙ МЕТЧИК

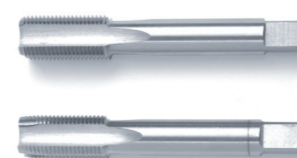

ТЕХНИЧЕСКАЯ ИНФОРМАЦИЯ

Норма	DIN 2184-2 (~ DIN40430)
Резьба	PG
Материал	HSS-G
Обр. Материал	Сталь
Вид отверстия	Сквозное / глухое
Направление	правый
Класс точности	2b

							Набор	Нр. 1	Нр. 2
UNS 1/4	40	5,7	56	14	6	4,9	00167010	00166011	00166013
UNS 1/4	36	5,65	56	14	6	4,9	00167020	00166021	00166023
UNS 1/4	24	5,3	56	19	6	4,9	00167030	00166031	00166033
UNS 7/16	24	10,1	63	20	8	6,2	00167040	00166041	00166043
UNS 1/2	24	11,65	70	22	9	7,0	00167050	00166051	00166053
UN 9/16	20	13,0	70	22	11	9,0	00167060	00166061	00166063
UN 11/16	20	16,2	80	22	14	11	00167070	00166071	00166073
UN 11/16	16	15,9	80	22	14	11	00167080	00166081	00166083
UNS 1	23,6	23,6	90	22	18	14,5	00167090	00166091	00166093
UN 1.1/16	12	24,9	90	22	20	16	00167100	00166101	00166103
UN 1.1/8	8	25,4	125	45	22	18	00167110	00166111	00166113
UN 1.3/16	12	28,1	90	22	22	18	00167120	00166121	00166123
UN 1.1/4	8	28,6	125	45	22	18	00167130	00166131	00166133
UN 1.5/16	12	31,3	125	40	28	22	00167140	00166141	00166143
UN 1.3/8	8	31,75	125	40	28	22	00167150	00166151	00166153
UN 1.1/2	8	34,9	125	40	25	22	00167160	00166161	00166163
UN 1.5/8	12	39,2	125	40	32	24	00167170	00166171	00166173
UN 1.5/8	8	38,1	125	40	32	24	00167180	00166181	00166183
UN 1.3/4	12	42,4	125	40	36	29	00167190	00166191	00166193
UN 1.3/4	8	41,3	125	40	36	29	00167200	00166201	00166203
UN 1.7/8	12	45,5	140	40	36	29	00167210	00166211	00166213
UN 1.7/8	8	44,5	140	40	36	29	00167220	00166221	00166223
UN 2	12	48,7	140	40	40	32	00167230	00166231	00166233
UN 2	8	47,7	140	40	40	32	00167240	00166241	00166243
UN 2.1/4	8	54,0	160	40	45	35	00167250	00166251	00166253
UN 2.1/2	8	60,3	180	56	50	39	00167260	00166261	00166263
UN 2.3/4	8	66,7	200	56	50	39	00167270	00166271	00166273
UN 3	8	73,0	220	60	50	39	00167280	00166281	00166283

							Набор	Нр. 1	Нр. 2
Pg 7	20	11,4	70	22	9	7	00191010	00190011	00190013
Pg 9	18	14,0	70	22	12	9	00191020	00190021	00190023
Pg 11	18	17,3	80	22	14	11	00191030	00190031	00190033
Pg 13,5	18	19,0	80	22	16	12	00191040	00190041	00190043
Pg 16	18	21,3	80	22	18	14,5	00191050	00190051	00190053
Pg 21	16	27,0	90	22	22	18	00191060	00190061	00190063
Pg 29	16	35,5	100	25	28	22	00191070	00190071	00190073
Pg 36	16	45,5	140	40	36	29	00191080	00190081	00190083
Pg 42	16	52,5	140	40	40	32	00191090	00190091	00190093
Pg 48	16	58,0	160	40	45	35	00191100	00190101	00190103

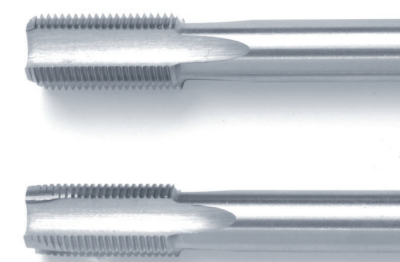

РУЧНОЙ МЕТЧИК

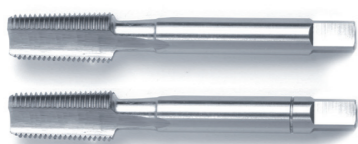

ТЕХНИЧЕСКАЯ ИНФОРМАЦИЯ

Норма	DIN 2184-2	Обр. Материал	Сталь
Резьба	NPT	Вид отверстия	Сквозное / глухое
Материал	HSS-G	Направление	правый

Символы	М	К	М	К	М	К	Набор	Нр. 1	Нр. 2
NPT 1/16	27	6,25	55	13	7,0	5,5	00181010	00180011	00180013
NPT 1/8	27	8,5	63	15	7,0	5,5	00181020	00180021	00180023
NPT 1/4	18	11,1	63	21	11,0	9,0	00181030	00180031	00180033
NPT 3/8	18	14,7	70	21	12,0	9,0	00181040	00180041	00180043
NPT 1/2	14	18,0	80	27	16,0	12,0	00181050	00180051	00180053
NPT 3/4	14	23,3	100	27	20,0	16,0	00181060	00180061	00180063
NPT 1	11,5	29,3	110	32	25,0	20,0	00181070	00180071	00180073
NPT 1.1/4	11,5	38,0	125	33	32,0	24,0	00181080	00180081	00180083
NPT 1.1/2	11,5	44,3	140	33	36,0	29,0	00181090	00180091	00180093
NPT 2	11,5	56,3	160	33	36,0	29,0	00181100	00180101	00180103
NPT 2.1/2	8	66,5	180	75	45,0	35,0	00181110	00180111	00180113
NPT 3	8	82,5	200	75	50,0	39,0	00181120	00180121	00180123
NPT 3.1/2	8	95	220	75	63,0	49,0	00181130	00180131	00180133
NPT 4	8	107,7	240	75	70,0	55,0	00181140	00180141	00180143

РУЧНОЙ МЕТЧИК



ТЕХНИЧЕСКАЯ ИНФОРМАЦИЯ

Норма	Заводской стандарт	Обр. Материал	Сталь
Резьба	Tr	Вид отверстия	Глухое < 3×d
Материал	HSS-G	Направление	правый
		Класс точности	ISO3 / 7H

Символы	М	К	М	К	М	К	Набор	Нр. 1	Нр. 2	Нр. 3
Tr 10×2*	2	8,0	90	33	7,0	5,5	00193010	00192011	—	00192013
Tr 10×3	3	7,0	100	40	7,0	5,5	00193020	00192021	00192022	00192023
Tr 12×2*	2	10,0	110	35	8,0	6,2	00193030	00192031	—	00192033
Tr 12×3	3	9,0	110	42	8,0	6,2	00193040	00192041	00192042	00192043
Tr 14×2*	2	12,0	120	36	10,0	8,0	00193050	00192051	—	00192053
Tr 14×3	3	11,0	130	43	10,0	8,0	00193060	00192061	00192062	00192063
Tr 14×4	4	10,0	130	54	10,0	8,0	00193070	00192071	00192072	00192073
Tr 16×2*	2	14,0	125	38	11,0	9,0	00193080	00192081	—	00192083
Tr 16×4	4	12,0	140	56	11,0	9,0	00193090	00192091	00192092	00192093
Tr 18×2*	2	16,0	135	40	12,0	9,0	00193100	00192101	—	00192103
Tr 18×4	4	14,0	150	58	12,0	9,0	00193110	00192111	00192112	00192113
Tr 20×2*	2	18,0	145	42	14,0	11,0	00193120	00192121	—	00192123
Tr 20×4	4	16,0	160	60	14,0	11,0	00193130	00192131	00192132	00192133
Tr 22×5	5	17,0	175	72	16,0	12,0	00193140	00192141	00192142	00192143
Tr 24×3*	3	21,0	170	52	18,0	14,5	00193150	00192151	—	00192153
Tr 24×5	5	19,0	190	74	18,0	14,5	00193160	00192161	00192162	00192163
Tr 26×5	5	21,0	210	76	20,0	16,0	00193170	00192171	00192172	00192173
Tr 28×5	5	23,0	220	78	22,0	18,0	00193180	00192181	00192182	00192183
Tr 30×3*	3	27,0	210	57	22,0	18,0	00193190	00192191	—	00192193
Tr 30×6	6	24,0	240	90	22,0	18,0	00193200	00192201	00192202	00192203
Tr 32×6	6	26,0	255	92	25,0	20,0	00193210	00192211	00192212	00192213
Tr 36×3*	3	33,0	240	68	28,0	22,0	00193220	00192221	—	00192223
Tr 36×6	6	30,0	280	96	28,0	22,0	00193230	00192231	00192232	00192233
Tr 40×7	7	33,0	310	107	32,0	24,0	00193240	00192241	00192242	00192243

* Набор 2-шт.

РУЧНОЙ МЕТЧИК

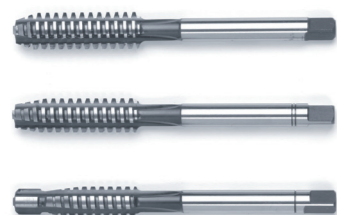

ТЕХНИЧЕСКАЯ ИНФОРМАЦИЯ

Норма	Заводской стандарт	Обр. Материал	Сталь
Резьба	Tr	Вид отверстия	Глухое < 3×d
Материал	HSSE-G	Направление	правый
		Класс точности	ISO3 / 7H

Набор	Нр. 1	Нр. 2	Нр. 3							
Tr 10×2*	2	8,0	90	33	7,0	5,5	00183010	00182011	—	00182013
Tr 10×3	3	7,0	100	40	7,0	5,5	00183020	00182021	00182022	00182023
Tr 12×2*	2	10,0	110	35	8,0	6,2	00183030	00182031	—	00182033
Tr 12×3	3	9,0	110	42	8,0	6,2	00183040	00182041	00182042	00182043
Tr 14×2*	2	12,0	120	36	10,0	8,0	00183050	00182051	—	00182053
Tr 14×3	3	11,0	130	43	10,0	8,0	00183060	00182061	00182062	00182063
Tr 14×4	4	10,0	130	54	10,0	8,0	00183070	00182071	00182072	00182073
Tr 16×2*	2	14,0	125	38	11,0	9,0	00183080	00182081	—	00182083
Tr 16×4	4	12,0	140	56	11,0	9,0	00183090	00182091	00182092	00182093
Tr 18×2*	2	16,0	135	40	12,0	9,0	00183100	00182101	—	00182103
Tr 18×4	4	14,0	150	58	12,0	9,0	00183110	00182111	00182112	00182113
Tr 20×2*	2	18,0	145	42	14,0	11,0	00183120	00182121	—	00182123
Tr 20×4	4	16,0	160	60	14,0	11,0	00183130	00182131	00182132	00182133
Tr 22×5	5	17,0	175	72	16,0	12,0	00183140	00182141	00182142	00182143
Tr 24×3*	3	21,0	170	52	18,0	14,5	00183150	00182151	—	00182153
Tr 24×5	5	19,0	190	74	18,0	14,5	00183160	00182161	00182162	00182163
Tr 26×5	5	21,0	210	76	20,0	16,0	00183170	00182171	00182172	00182173
Tr 28×5	5	23,0	220	78	22,0	18,0	00183180	00182181	00182182	00182183
Tr 30×3*	3	27,0	210	57	22,0	18,0	00183190	00182191	—	00182193
Tr 30×6	6	24,0	240	90	22,0	18,0	00183200	00182201	00182202	00182203
Tr 32×6	6	26,0	255	92	25,0	20,0	00183210	00182211	00182212	00182213
Tr 36×3*	3	33,0	240	68	28,0	22,0	00183220	00182221	—	00182223
Tr 36×6	6	30,0	280	96	28,0	22,0	00183230	00182231	00182232	00182233
Tr 40×7	7	33,0	310	107	32,0	24,0	00183240	00182241	00182242	00182243

* Набор 2-шт.

РУЧНОЙ МЕТЧИК

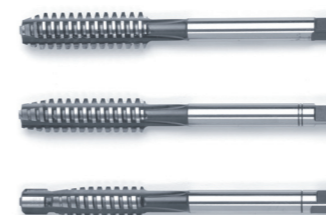

ТЕХНИЧЕСКАЯ ИНФОРМАЦИЯ

Норма	Заводской стандарт	Обр. Материал	Сталь
Резьба	Tr	Вид отверстия	Глухое < 3×d
Материал	HSSE-G	Направление	левый
		Класс точности	ISO3 / 7H

Набор	Нр. 1	Нр. 2	Нр. 3							
Tr 10×2*	2	8,0	90	33	7,0	5,5	00189010	00188011	—	00188013
Tr 10×3	3	7,0	100	40	7,0	5,5	00189020	00188021	00188022	00188023
Tr 12×2*	2	10,	110	35	8,0	6,2	00189030	00188031	—	00188033
Tr 12×3	3	9,0	110	42	8,0	6,2	00189040	00188041	00188042	00188043
Tr 14×2*	2	12,0	120	36	10,0	8,0	00189050	00188051	—	00188053
Tr 14×3	3	11,0	130	43	10,0	8,0	00189060	00188061	00188062	00188063
Tr 14×4	4	10,0	130	54	10,0	8,0	00189070	00188071	00188072	00188073
Tr 16×2*	2	14,0	125	38	11,0	9,0	00189080	00188081	—	00188083
Tr 16×4	4	12,0	140	56	11,0	9,0	00189090	00188091	00188092	00188093
Tr 18×2*	2	16,0	135	40	12,0	9,0	00189100	00188101	—	00188103
Tr 18×4	4	14,0	150	58	12,0	9,0	00189110	00188111	00188112	00188113
Tr 20×2*	2	18,0	145	42	14,0	11,0	00189120	00188121	—	00188123
Tr 20×4	4	16,0	160	60	14,0	11,0	00189130	00188131	00188132	00188133
Tr 22×5	5	17,0	175	72	16,0	12,0	00189140	00188141	00188142	00188143
Tr 24×3*	3	21,0	170	52	18,0	14,5	00189150	00188151	—	00188153
Tr 24×5	5	19,0	190	74	18,0	14,5	00189160	00188161	00188162	00188163
Tr 26×5	5	21,0	210	76	20,0	16,0	00189170	00188171	00188172	00188173
Tr 28×5	5	23,0	220	78	22,0	18,0	00189180	00188181	00188182	00188183
Tr 30×3*	3	27,0	210	57	22,0	18,0	00189190	00188191	—	00188193
Tr 30×6	6	24,0	240	90	22,0	18,0	00189200	00188201	00188202	00188203
Tr 32×6	6	26,0	255	92	25,0	20,0	00189210	00188211	00188212	00188213
Tr 36×3*	3	33,0	240	68	28,0	22,0	00189220	00188221	—	00188223
Tr 36×6	6	30,0	280	96	28,0	22,0	00189230	00188231	00188232	00188233
Tr 40×7	7	33,0	310	107	32,0	24,0	00189240	00188241	00188242	00188243

* Набор 2-шт.



▶ МАШИННО РУЧНОЙ МЕТЧИК

DIN 352



ВИНТОВАЯ ПОДТОЧКА

ФОРМА В 3,5-5
витков, средняя заборная часть с винтовой подточкой для сквозных отверстий

ЧЕТЫРЁХГРАННИК ПО DIN 10
для закрепления метчиков в воротке (vW).

Метчики до М6 имеют утолщённый хвостовик и 3 канавки. Метчики от М7 имеют проходной хвостовик и 4 канавки.

**МЕТЧИК
DIN 352 · В · М8 · 6Н · HSS**

Обозначение

DIN 352 = Немецкий институт по стандартизации
В = 3,5 – 5 витков, средняя заборная часть с винтовой подточкой для сквозных отверстий
М8 = размер в мм для метрических ISO2-резьб в соответствии с DIN 13
6H = класс точности по DIN 802, часть 1
HSS = быстрорежущая сталь группы сплавов HSS

ФОРМА А
6 – 8 витков, длинная заборная часть для сквозных отверстий

ФОРМА С
2 – 3 витка, короткая заборная часть, для глухих и сквозных отверстий



ЗАЖИМ С ЦЕНТРОВОЧНЫМ УРОВНЕМ

ШЕСТИГРАННИК 

МАШИННО РУЧНОЙ МЕТЧИК-БИТ
для метрических ISO-резьб от М3 до М10 с 1/4-хвостовиком подходящим для зажимов по DIN 3126 до D3,6 для ручного и машинного применения

ФОРМА В
средняя заборная часть, 3,5 – 5 витков

МАГНИТНЫЙ ДЕРЖАТЕЛЬ



МАШИННО РУЧНОЙ МЕТЧИК



ТЕХНИЧЕСКАЯ ИНФОРМАЦИЯ

Норма	DIN 352	Вид отверстия	Глухое < 1хd
Резьба	M	Направление	правый
Материал	HSS-G	Класс точности	6h
Форма	Форма А	Обр. Материал	Сталь

Машинно-ручной метчик, однопроходный, 5-6 витков резьбы

Иконка	М	мм	мм	мм	мм	мм	Арт.-Нр.
M 3	0,5	2,5	40	11	3,5	2,7	00202130
M 4	0,7	3,3	45	13	4,5	3,4	00202150
M 5	0,8	4,2	50	16	6,0	4,2	00202170
M 6	1,0	5,0	56	19	6,0	5,0	00202190
M 8	1,25	6,8	63	22	6,0	6,8	00202210
M 10	1,5	8,5	70	24	7,0	8,5	00202230
M 12	1,75	10,2	75	28	9,0	7,0	00202250
M 14	2,0	12,0	80	30	11,0	9,0	00202260
M 16	2,0	14,0	80	32	12,0	9,0	00202270
M 18	2,5	15,5	95	34	14,0	11,0	00202280
M 20	2,5	17,5	95	34	16,0	12,0	00202290
M 22	2,5	19,5	100	34	18,0	14,5	00202300
M 24	3,0	21,0	110	38	18,0	14,5	00202310

МАШИННО РУЧНОЙ МЕТЧИК



ТЕХНИЧЕСКАЯ ИНФОРМАЦИЯ

Норма	DIN 352	Вид отверстия	Глухое < 1хd
Резьба	M	Направление	правый
Материал	HSS-G	Класс точности	6h
Форма	Форма В	Обр. Материал	Сталь

Машинно-ручной метчик, однопроходный, 4-5 витков резьбы

Иконка	М	мм	мм	мм	мм	мм	Арт.-Нр.
M 3	0,5	2,5	40	11	3,5	2,7	00204130
M 4	0,7	3,3	45	13	4,5	3,4	00204150
M 5	0,8	4,2	50	16	6,0	4,2	00204170
M 6	1,0	5,0	56	19	6,0	5,0	00204190
M 7	1,0	6,0	56	19	6,0	6,0	00204200
M 8	1,25	6,8	63	22	6,0	6,8	00204210
M 10	1,5	8,5	70	24	7,0	8,5	00204230
M 12	1,75	10,2	75	28	9,0	7,0	00204250

Иконка	М	мм	мм	мм	мм	мм	Арт.-Нр.
M 14	2,0	12,0	80	30	11,0	9,0	00204260
M 16	2,0	14,0	80	32	12,0	9,0	00204270
M 18	2,5	15,5	95	34	14,0	11,0	00204280
M 20	2,5	17,5	95	34	16,0	12,0	00204290
M 22	2,5	19,5	100	34	18,0	14,5	00204300
M 24	3,0	21,0	110	38	18,0	14,5	00204310
M 27	3,0	24,0	110	38	20,0	16,0	00204320
M 30	3,5	26,5	125	45	22,0	18,0	00204330
M 33	3,5	29,5	125	50	25,0	20,0	00204340
M 36	4,0	32,0	150	56	28,0	22,0	00204350
M 39	4,0	35,0	150	60	32,0	24,0	00204360
M 42	4,5	37,5	150	60	32,0	24,0	00204370
M 45	4,5	40,5	160	65	36,0	29,0	00204380
M 48	5,0	43,0	180	70	36,0	29,0	00204390
M 52	5,0	47,0	180	70	40,0	32,0	00204400
M 56	5,5	51,5	180	70	40,0	32,0	00204410
M 60	5,5	54,5	200	75	45,0	35,0	00204420
M 64	6,0	58,0	220	80	50,0	39,0	00204430
M 68	6,0	62,0	220	80	50,0	39,0	00204440
M 72	6,0	66,0	240	80	50,0	39,0	00204450
M 76	6,0	70,0	240	80	50,0	39,0	00204460
M 80	6,0	74,0	260	85	50,0	39,0	00204470
M 84	6,0	78,0	260	85	50,0	39,0	00204480
M 88	6,0	82,0	260	85	50,0	39,0	00204490
M 90	6,0	84,0	260	85	50,0	39,0	00204500
M 92	6,0	86,0	280	90	56,0	44,0	00204510
M 96	6,0	90,0	280	90	56,0	44,0	00204520
M 100	6,0	94,0	300	90	56,0	44,0	00204530

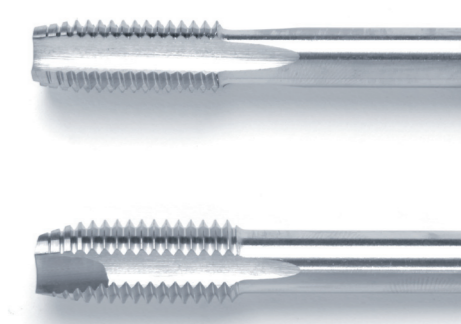

МАШИННО РУЧНОЙ МЕТЧИК



ТЕХНИЧЕСКАЯ ИНФОРМАЦИЯ

Норма	DIN 352	Вид отверстия	сквозное <1.1/2xd
Резьба	M	Направление	правый
Материал	HSS-G	Класс точности	6h
Форма	Форма С	Обр. Материал	Сталь

Машинно-ручной метчик, однопроходный, 2-3 витка резьбы

М	0,5	2,5	40	11	3,5	2,7	Арт.-Нр.
M 3	0,5	2,5	40	11	3,5	2,7	00205130
M 4	0,7	3,3	45	13	4,5	3,4	00205150
M 5	0,8	4,2	50	16	6,0	4,2	00205170
M 6	1,0	5,0	56	19	6,0	5,0	00205190
M 7	1,0	6,0	56	19	6,0	6,0	00205200
M 8	1,25	6,8	63	22	6,0	6,8	00205210
M 10	1,5	8,5	70	24	7,0	8,5	00205230
M 12	1,75	10,2	75	28	9,0	7,0	00205250
M 14	2,0	12,0	80	30	11,0	9,0	00205260
M 16	2,0	14,0	80	32	12,0	9,0	00205270
M 18	2,5	15,5	95	34	14,0	11,0	00205280
M 20	2,5	17,5	95	34	16,0	12,0	00205290
M 22	2,5	19,5	100	34	18,0	14,5	00205300
M 24	3,0	21,0	110	38	18,0	14,5	00205310
M 27	3,0	24,0	110	38	20,0	16,0	00205320
M 30	3,5	26,5	125	45	22,0	18,0	00205330
M 33	3,5	29,5	125	50	25,0	20,0	00205340
M 36	4,0	32,0	150	56	28,0	22,0	00205350
M 39	4,0	35,0	150	60	32,0	24,0	00205360
M 42	4,5	37,5	150	60	32,0	24,0	00205370
M 45	4,5	40,5	160	65	36,0	29,0	00205380
M 48	5,0	43,0	180	70	36,0	29,0	00205390
M 52	5,0	47,0	180	70	40,0	32,0	00205400
M 56	5,5	51,5	180	70	40,0	32,0	00205410
M 60	5,5	54,5	200	75	45,0	35,0	00205420
M 64	6,0	58,0	220	80	50,0	39,0	00205430
M 68	6,0	62,0	220	80	50,0	39,0	00205440
M 72	6,0	66,0	240	80	50,0	39,0	00205450
M 76	6,0	70,0	240	80	50,0	39,0	00205460
M 80	6,0	74,0	260	85	50,0	39,0	00205470
M 84	6,0	78,0	260	85	50,0	39,0	00205480
M 88	6,0	82,0	260	85	50,0	39,0	00205490
M 90	6,0	84,0	260	85	50,0	39,0	00205500
M 92	6,0	86,0	280	90	56,0	44,0	00205510
M 96	6,0	90,0	280	90	56,0	44,0	00205520
M 100	6,0	94,0	300	90	56,0	44,0	00205530

МАШИННО РУЧНОЙ МЕТЧИК



ТЕХНИЧЕСКАЯ ИНФОРМАЦИЯ

Норма	DIN 352	Вид отверстия	сквозное <1.1/2xd
Резьба	M	Направление	правый
Материал	HSSE-G	Класс точности	6h
Форма	Форма С/RSP 35°	Обр. Материал	Сталь

Машинно-ручной метчик, однопроходный со спиральной канавкой, 2-3 витка резьбы

М	0,5	2,5	40	11	3,5	2,7	Арт.-Нр.
M 3	0,5	2,5	40	11	3,5	2,7	00219130
M 4	0,7	3,3	45	13	4,5	3,4	00219150
M 5	0,8	4,2	50	16	6,0	4,2	00219170
M 6	1,0	5,0	56	19	6,0	5,0	00219190
M 8	1,25	6,8	63	22	6,0	6,8	00219210
M 10	1,5	8,5	70	24	7,0	8,5	00219230
M 12	1,75	10,2	75	28	9,0	7,0	00219250
M 14	2,0	12,0	80	30	11,0	9,0	00219260
M 16	2,0	14,0	80	32	12,0	9,0	00219270
M 18	2,5	15,5	95	34	14,0	11,0	00219280
M 20	2,5	17,5	95	34	16,0	12,0	00219290
M 22	2,5	19,5	100	34	18,0	14,5	00219300
M 24	3,0	21,0	110	38	18,0	14,5	00219310

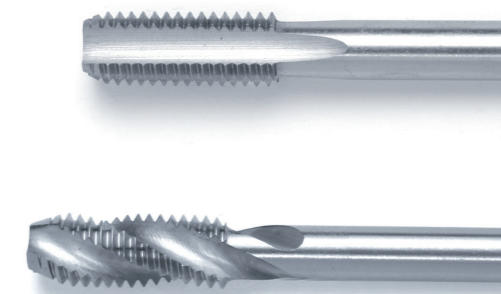

МАШИННО РУЧНОЙ МЕТЧИК



ТЕХНИЧЕСКАЯ ИНФОРМАЦИЯ

Норма	DIN 352	Вид отверстия	Глухое <1.1/2xd
Резьба	M	Направление	правый
Материал	HSSE-G	Класс точности	6h
Форма	Форма В	Обр. Материал	Сталь

Машинно-ручной метчик, однопроходный, 4-5 витков резьбы, со спиральной подточкой (стружколом)

М	0,5	2,5	40	11	3,5	2,7	Арт.-Нр.
М 3	0,5	2,5	40	11	3,5	2,7	00206130
М 4	0,7	3,3	45	13	4,5	3,4	00206150
М 5	0,8	4,2	50	16	6,0	4,2	00206170
М 6	1,0	5,0	56	19	6,0	5,0	00206190
М 8	1,25	6,8	63	22	6,0	6,8	00206210
М 10	1,5	8,5	70	24	7,0	8,5	00206230
М 12	1,75	10,2	75	28	9,0	7,0	00206250
М 14	2,0	12,0	80	30	11,0	9,0	00206260
М 16	2,0	14,0	80	32	12,0	9,0	00206270
М 18	2,5	15,5	95	34	14,0	11,0	00206280
М 20	2,5	17,5	95	34	16,0	12,0	00206290
М 22	2,5	19,5	100	34	18,0	14,5	00206300
М 24	3,0	21,0	110	38	18,0	14,5	00206310

МАШИННО РУЧНОЙ МЕТЧИК



ТЕХНИЧЕСКАЯ ИНФОРМАЦИЯ

Норма	DIN 352	Вид отверстия	Глухое <1.1/2xd
Резьба	M	Направление	правый
Материал	HSSE-G	Класс точности	6h
Форма	Форма В/AZ	Обр. Материал	Бронза, Медь, Алюминий

Машинно-ручной метчик, однопроходный, 4-5 витков резьбы, со спиральной подточкой (стружколом), шахматный

М	0,5	2,5	40	11	3,5	2,7	Арт.-Нр.
М 3	0,5	2,5	40	11	3,5	2,7	00208130
М 4	0,7	3,3	45	13	4,5	3,4	00208150
М 5	0,8	4,2	50	16	6,0	4,2	00208170
М 6	1,0	5,0	56	19	6,0	5,0	00208190
М 8	1,25	6,8	63	22	6,0	6,8	00208210
М 10	1,5	8,5	70	24	7,0	8,5	00208230
М 12	1,75	10,2	75	28	9,0	7,0	00208250
М 14	2,0	12,0	80	30	11,0	9,0	00208260
М 16	2,0	14,0	80	32	12,0	9,0	00208270
М 18	2,5	15,5	95	34	14,0	11,0	00208280
М 20	2,5	17,5	95	34	16,0	12,0	00208290
М 22	2,5	19,5	100	34	18,0	14,5	00208300
М 24	3,0	21,0	110	38	18,0	14,5	00208310

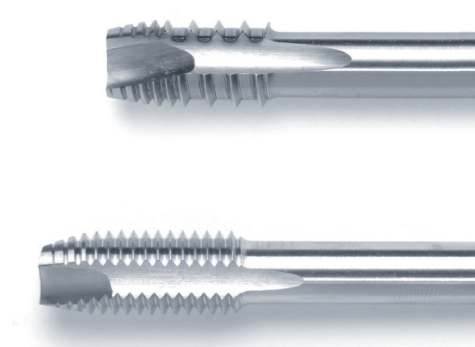

МАШИННО РУЧНОЙ МЕТЧИК



ТЕХНИЧЕСКАЯ ИНФОРМАЦИЯ

Норма	DIN 2181	Вид отверстия	сквозное <1.1/2хd
Резьба	MF	Направление	правый
Материал	HSS-G	Класс точности	6h
Форма	Форма С	Обр. Материал	Сталь

Машинно-ручной метчик, однопроходный, 2-3 витка резьбы

							Арт.-Нр.
MF 3 × 0,35	0,35	2,65	36	10	3,5	2,7	00220200
MF 3,5 × 0,35	0,35	3,15	36	10	4,0	3,0	00220220
MF 4 × 0,35	0,35	3,65	36	10	4,5	3,4	00220230
MF 4 × 0,5	0,5	3,5	40	12	4,5	3,4	00220240
MF 4,5 × 0,35	0,35	4,15	40	12	4,5	3,4	00220250
MF 4,5 × 0,5	0,5	4,0	40	12	4,5	3,4	00220260
MF 5 × 0,5	0,5	4,5	45	14	6,0	4,9	00220280
MF 5 × 0,75	0,75	4,25	48	16	6,0	4,9	00220290
MF 5,5 × 0,5	0,5	5,0	48	16	6,0	4,9	00220300
MF 5,5 × 0,75	0,75	4,75	48	16	6,0	4,9	00220310
MF 6 × 0,5	0,5	5,5	45	14	6,0	4,9	00220320
MF 6 × 0,75	0,75	5,25	48	16	6,0	4,9	00220330
MF 7 × 0,5	0,5	6,5	48	16	6,0	4,9	00220350
MF 7 × 0,75	0,75	6,25	48	16	6,0	4,9	00220360
MF 8 × 0,5	0,5	7,5	50	14	6,0	4,9	00220380
MF 8 × 0,75	0,75	7,25	50	16	6,0	4,9	00220390
MF 8 × 1	1,0	7,0	56	18	6,0	4,9	00220400
MF 8 × 1,5	1,5	6,5	56	22	6,0	4,9	00220410
MF 9 × 0,5	0,5	8,5	56	18	7,0	5,5	00220420
MF 9 × 0,75	0,75	8,25	56	18	7,0	5,5	00220430
MF 9 × 1	1,0	8,0	56	18	7,0	5,5	00220440
MF 10 × 0,5	0,5	9,5	50	14	7,0	5,5	00220450
MF 10 × 0,75	0,75	9,25	56	16	7,0	5,5	00220460
MF 10 × 1	1,0	9,0	63	18	7,0	5,5	00220470
MF 10 × 1,25	1,25	8,8	63	18	7,0	5,5	00220480
MF 11 × 0,5	0,5	10,5	63	18	8,0	6,2	00220490
MF 11 × 0,75	0,75	10,25	63	18	8,0	6,2	00220500
MF 11 × 1	1,0	10,0	63	18	8,0	6,2	00220510
MF 11 × 1,25	1,25	9,75	63	18	8,0	6,2	00220520
MF 12 × 0,5	0,5	11,5	63	16	9,0	7,0	00220530
MF 12 × 0,75	0,75	11,25	63	16	9,0	7,0	00220540
MF 12 × 1	1,0	11,0	63	20	9,0	7,0	00220550
MF 12 × 1,25	1,25	10,8	63	20	9,0	7,0	00220560
MF 12 × 1,5	1,5	10,5	70	20	9,0	7,0	00220570
MF 13 × 0,5	0,5	12,5	63	20	11,0	9,0	00220580
MF 13 × 0,75	0,75	12,25	63	20	11,0	9,0	00220590

							Арт.-Нр.
MF 13 × 1	1,0	12,0	63	20	11,0	9,0	00220600
MF 13 × 1,25	1,25	11,75	70	20	11,0	9,0	00220610
MF 13 × 1,5	1,5	11,5	70	20	11,0	9,0	00220620
MF 14 × 0,5	0,5	13,5	70	16	11,0	9,0	00220630
MF 14 × 0,75	0,75	13,25	70	16	11,0	9,0	00220640
MF 14 × 1	1,0	13,0	70	20	11,0	9,0	00220650
MF 14 × 1,25	1,25	12,8	70	20	11,0	9,0	00220660
MF 14 × 1,5	1,5	12,5	70	20	11,0	9,0	00220670
MF 15 × 0,5	0,5	14,5	70	20	12,0	9,0	00220680
MF 15 × 0,75	0,75	14,25	70	20	12,0	9,0	00220690
MF 15 × 1	1,0	14,0	70	20	12,0	9,0	00220700
MF 15 × 1,25	1,25	13,8	70	20	12,0	9,0	00220710
MF 15 × 1,5	1,5	13,5	70	20	12,0	9,0	00220720
MF 16 × 0,5	0,5	15,5	70	20	12,0	9,0	00220730
MF 16 × 0,75	0,75	15,25	70	20	12,0	9,0	00220740
MF 16 × 1	1,0	15,0	70	20	12,0	9,0	00220750
MF 16 × 1,25	1,25	14,75	70	20	12,0	9,0	00220760
MF 16 × 1,5	1,5	14,5	70	20	12,0	9,0	00220770
MF 17 × 0,75	0,75	16,25	70	20	12,0	9,0	00220780
MF 17 × 1	1,0	16,0	70	20	12,0	9,0	00220790
MF 17 × 1,5	1,5	15,5	70	20	12,0	9,0	00220800
MF 18 × 0,5	0,5	17,5	80	22	14,0	11,0	00220820
MF 18 × 0,75	0,75	17,25	80	22	14,0	11,0	00220830
MF 18 × 1	1,0	17,0	80	22	14,0	11,0	00220840
MF 18 × 1,25	1,25	16,75	80	22	14,0	11,0	00220850
MF 18 × 1,5	1,5	16,5	80	22	14,0	11,0	00220860
MF 18 × 2	2,0	16,0	90	25	14,0	11,0	00220870
MF 19 × 1	1,0	18,0	80	22	14,0	11,0	00220880
MF 19 × 1,5	1,5	17,5	80	22	14,0	11,0	00220900
MF 20 × 0,5	0,5	19,5	80	22	16,0	12,0	00220910
MF 20 × 0,75	0,75	19,25	80	22	16,0	12,0	00220920
MF 20 × 1	1,0	19,0	80	22	16,0	12,0	00220930
MF 20 × 1,25	1,25	18,75	80	22	16,0	12,0	00220940
MF 20 × 1,5	1,5	18,5	80	22	16,0	12,0	00220950
MF 20 × 2	2,0	18,0	90	25	16,0	12,0	00220960
MF 21 × 1	1,0	20,0	80	22	16,0	12,0	00220980
MF 21 × 1,5	1,5	19,5	80	22	16,0	12,0	00221000
MF 22 × 0,5	0,5	21,5	80	22	18,0	14,5	00221010
MF 22 × 0,75	0,75	21,25	80	22	18,0	14,5	00221020
MF 22 × 1	1,0	21,0	80	22	18,0	14,5	00221030
MF 22 × 1,25	1,25	20,75	80	22	18,0	14,5	00221040
MF 22 × 1,5	1,5	20,5	80	22	18,0	14,5	00221050
MF 22 × 2	2,0	20,0	90	25	18,0	14,5	00221060
MF 23 × 1	1,0	22,0	80	22	18,0	14,5	00221070

							Арт.-Нр.
MF 23 × 1,5	1,5	21,5	80	22	18,0	14,5	00221080
MF 24 × 0,5	0,5	23,5	80	22	18,0	14,5	00221090
MF 24 × 0,75	0,75	23,25	80	22	18,0	14,5	00221100
MF 24 × 1	1,0	23,0	80	22	18,0	14,5	00221110
MF 24 × 1,25	1,25	22,75	80	22	18,0	14,5	00221120
MF 24 × 1,5	1,5	22,5	80	22	18,0	14,5	00221130
MF 24 × 2	2,0	22,0	90	25	18,0	14,5	00221140
MF 25 × 1	1,0	24,0	90	22	18,0	14,5	00221150
MF 25 × 1,5	1,5	23,5	90	22	18,0	14,5	00221170
MF 25 × 2	2,0	23,0	100	28	18,0	14,5	00221180
MF 26 × 1	1,0	25,0	90	22	18,0	14,5	00221190
MF 26 × 1,25	1,25	24,75	90	22	18,0	14,5	00221200
MF 26 × 1,5	1,5	24,5	90	22	18,0	14,5	00221210
MF 26 × 2	2,0	24,0	100	28	18,0	14,5	00221220
MF 27 × 1	1,0	26,0	90	22	20,0	16,0	00221230
MF 27 × 1,5	1,5	25,5	90	22	20,0	16,0	00221240
MF 27 × 2	2,0	25,0	100	28	20,0	16,0	00221250
MF 28 × 1	1,0	27,0	90	22	20,0	16,0	00221260
MF 28 × 1,5	1,5	26,5	90	22	20,0	16,0	00221270
MF 28 × 2	2,0	26,0	100	28	20,0	16,0	00221280
MF 30 × 1	1,0	29,0	90	22	22,0	18,0	00221290
MF 30 × 1,5	1,5	28,5	90	22	22,0	18,0	00221300
MF 30 × 2	2,0	28,0	100	28	22,0	18,0	00221310
MF 30 × 3	3,0	27,0	110	32	22,0	18,0	00221320
MF 32 × 1	1,0	31,0	90	22	22,0	18,0	00221330
MF 32 × 1,5	1,5	30,5	90	22	22,0	18,0	00221340
MF 32 × 2	2,0	30,0	100	28	22,0	18,0	00221350
MF 32 × 3	3,0	29,0	125	36	22,0	18,0	00221360
MF 33 × 1	1,0	32,0	100	25	25,0	20,0	00221370
MF 33 × 1,5	1,5	31,5	100	25	25,0	20,0	00221380
MF 33 × 2	2,0	31,0	110	32	25,0	20,0	00221390
MF 33 × 3	3,0	30,0	125	36	25,0	20,0	00221400
MF 34 × 1	1,0	33,0	100	25	28,0	22,0	00221410
MF 34 × 1,5	1,5	32,5	100	25	28,0	22,0	00221420
MF 34 × 2	2,0	32,0	110	32	28,0	22,0	00221430
MF 34 × 3	3,0	31,0	125	36	28,0	22,0	00221440
MF 35 × 1	1,0	34,0	100	25	28,0	22,0	00221450
MF 35 × 1,5	1,5	33,5	100	25	28,0	22,0	00221460
MF 35 × 2	2,0	33,0	110	32	28,0	22,0	00221470
MF 35 × 3	3,0	32,0	125	36	28,0	22,0	00221480
MF 36 × 1	1,0	35,0	100	25	28,0	22,0	00221490
MF 36 × 1,5	1,5	34,5	100	25	28,0	22,0	00221500
MF 36 × 2	2,0	34,0	110	32	28,0	22,0	00221510
MF 36 × 3	3,0	33,0	125	36	28,0	22,0	00221520

							Арт.-Нр.
MF 38 × 1	1,0	37,0	110	25	28,0	22,0	00221530
MF 38 × 1,5	1,5	36,5	110	25	28,0	22,0	00221540
MF 38 × 2	2,0	36,0	125	32	28,0	22,0	00221550
MF 38 × 3	3,0	35,0	125	36	28,0	22,0	00221560
MF 39 × 1,5	1,5	37,5	110	25	32,0	24,0	00221570
MF 39 × 2	2,0	37,0	125	32	32,0	24,0	00221580
MF 39 × 3	3,0	36,0	125	36	32,0	24,0	00221590
MF 40 × 1	1,0	39,0	110	25	32,0	24,0	00221600
MF 40 × 1,5	1,5	38,5	110	25	32,0	24,0	00221610
MF 40 × 2	2,0	38,0	125	32	32,0	24,0	00221620
MF 40 × 3	3,0	37,0	125	36	32,0	24,0	00221630
MF 42 × 1,5	1,5	40,5	110	25	32,0	24,0	00221640
MF 42 × 2	2,0	40,0	125	32	32,0	24,0	00221650
MF 42 × 3	3,0	39,0	125	36	32,0	24,0	00221660
MF 42 × 4	4,0	38,0	140	40	32,0	24,0	00221670
MF 45 × 1	1,0	44,0	110	25	36,0	29,0	00221680
MF 45 × 1,5	1,5	43,5	110	25	36,0	29,0	00221690
MF 45 × 2	2,0	43,0	125	32	36,0	29,0	00221700
MF 45 × 3	3,0	42,0	125	36	36,0	29,0	00221710
MF 45 × 4	4,0	41,0	140	40	36,0	29,0	00221720
MF 48 × 1	1,0	47,0	125	25	36,0	29,0	00221730
MF 48 × 1,5	1,5	46,5	125	25	36,0	29,0	00221740
MF 48 × 2	2,0	46,0	140	32	36,0	29,0	00221750
MF 48 × 3	3,0	45,0	140	36	36,0	29,0	00221760
MF 48 × 4	4,0	44,0	140	40	36,0	29,0	00221770
MF 50 × 1	1,0	49,0	125	25	36,0	29,0	00221780
MF 50 × 1,5	1,5	48,5	125	25	36,0	29,0	00221790
MF 50 × 2	2,0	48,0	140	32	36,0	29,0	00221800
MF 50 × 3	3,0	47,0	140	36	36,0	29,0	00221810
MF 50 × 4	4,0	46,0	140	40	40,0	32,0	00221820
MF 52 × 1	1,0	51,0	125	25	40,0	32,0	00221830
MF 52 × 1,5	1,5	50,5	125	25	40,0	32,0	00221840
MF 52 × 2	2,0	50,0	140	32	40,0	32,0	00221850
MF 52 × 3	3,0	49,0	140	36	40,0	32,0	00221860
MF 52 × 4	4,0	48,0	140	40	40,0	32,0	00221870

МАШИННО РУЧНОЙ МЕТЧИК



ТЕХНИЧЕСКАЯ ИНФОРМАЦИЯ

Норма	DIN 2184-2	Вид отверстия	Глухое <3хd
Резьба	BSW	Направление	правый
Материал	HSS-G	Класс точности	6h
Форма	Форма В	Обр. Материал	Сталь

Машинно-ручной метчик, однопроходный, 4-5 витков резьбы, со спиральной подточкой (стружколом)

Сечение	М	Н	М	Н	М	Н	Арт.-Нр.
BSW 1/16	60	1,2	32	8	2,5	2,1	00236010
BSW 3/32	48	1,9	40	9	2,8	2,1	00236020
BSW 1/8	40	2,6	40	11	3,5	2,7	00236030
BSW 5/32	32	3,2	45	13	4,5	3,4	00236040
BSW 3/16	24	3,8	50	16	6	4,9	00236050
BSW 7/32	24	4,6	56	17	6	4,9	00236060
BSW 1/4	20	5,1	56	19	6	4,9	00236070
BSW 5/16	18	6,5	63	22	6	4,9	00236080
BSW 3/8	16	7,9	70	24	7	5,5	00236090
BSW 7/16	14	9,3	70	24	7	5,5	00236100
BSW 1/2	12	10,5	75	28	9	7,0	00236110
BSW 9/16	12	12,0	80	30	11	9,0	00236120
BSW 5/8	11	13,5	80	32	12	9,0	00236130
BSW 3/4	10	16,5	95	34	14	11,0	00236140
BSW 7/8	9	19,5	100	34	18	14,5	00236150
BSW 1"	8	22,0	110	38	18	14,5	00236160
BSW 1.1/8	7	25,0	125	45	22	18,0	00236170
BSW 1.1/4	7	28,0	125	45	22	18,0	00236180
BSW 1.3/8	6	30,5	150	56	28	22,0	00236190
BSW 1.1/2	6	33,5	150	56	28	22,0	00236200
BSW 1.5/8	5	35,5	150	60	32	24,0	00236210
BSW 1.3/4	5	39,0	160	65	36	29,0	00236220
BSW 1.7/8	4,5	41,5	180	70	36	29,0	00236230
BSW 2"	4,5	44,5	180	70	40	32,0	00236240

МАШИННО РУЧНОЙ МЕТЧИК



ТЕХНИЧЕСКАЯ ИНФОРМАЦИЯ

Норма	DIN 2184-2	Вид отверстия	сквозное <1.1/2хd
Резьба	BSW	Направление	правый
Материал	HSS-G	Класс точности	6h
Форма	Форма С	Обр. Материал	Сталь

Машинно-ручной метчик, однопроходный, 2-3 витка резьбы

Сечение	М	Н	М	Н	М	Н	Арт.-Нр.
BSW 1/16	60	1,2	32	8	2,5	2,1	00235010
BSW 3/32	48	1,9	40	9	2,8	2,1	00235020
BSW 1/8	40	2,6	40	11	3,5	2,7	00235030
BSW 5/32	32	3,2	45	13	4,5	3,4	00235040
BSW 3/16	24	3,8	50	16	6	4,9	00235050
BSW 7/32	24	4,6	56	17	6	4,9	00235060
BSW 1/4	20	5,1	56	19	6	4,9	00235070
BSW 5/16	18	6,5	63	22	6	4,9	00235080
BSW 3/8	16	7,9	70	24	7	5,5	00235090
BSW 7/16	14	9,3	70	24	7	5,5	00235100
BSW 1/2	12	10,5	75	28	9	7,0	00235110
BSW 9/16	12	12,0	80	30	11	9,0	00235120
BSW 5/8	11	13,5	80	32	12	9,0	00235130
BSW 3/4	11	16,5	95	34	14	11,0	00235140
BSW 7/8	9	19,5	100	34	18	14,5	00235150
BSW 1"	8	22,0	110	38	18	14,5	00235160
BSW 1.1/8	7	25,0	125	45	22	18,0	00235170
BSW 1.1/4	7	28,0	125	45	22	18,0	00235180
BSW 1.3/8	6	30,5	150	56	28	22,0	00235190
BSW 1.1/2	6	33,5	150	56	28	22,0	00235200
BSW 1.5/8	5	35,5	150	60	32	24,0	00235210
BSW 1.3/4	5	39,0	160	65	36	29,0	00235220
BSW 1.7/8	4,5	41,5	180	70	36	29,0	00235230
BSW 2"	4,5	44,5	180	70	40	32,0	00235240

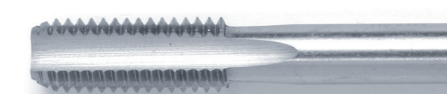

МАШИННО РУЧНОЙ МЕТЧИК



ТЕХНИЧЕСКАЯ ИНФОРМАЦИЯ

Норма	DIN 5157	Вид отверстия	Сквозное / глухое
Резьба	BSP	Направление	правый
Материал	HSS-G	Класс точности	6h
Форма	Форма С	Обр. Материал	Сталь

Машинно-ручной метчик, однопроходный, 2-3 витка резьбы

Сечение	М	М	М	М	М	М	Арт.-Нр.
BSP 1/8	28	8,8	63	20	7,0	5,5	00258030
BSP 1/4	19	11,8	70	22	11,0	9,0	00258070
BSP 3/8	19	15,3	70	22	12,0	9,0	00258090
BSP 1/2	14	19,0	80	22	16,0	12,0	00258110
BSP 5/8	14	21,0	80	22	18,0	14,5	00258130
BSP 3/4	14	24,5	90	22	20,0	16,0	00258140
BSP 7/8	14	28,3	90	22	22,0	18,0	00258150
BSP 1	11	30,5	100	25	25,0	20,0	00258160
BSP 1.1/8	11	35,5	125	40	28,0	22,0	00258170
BSP 1.1/4	11	39,5	125	40	32,0	24,0	00258180
BSP 1.3/8	11	42,0	125	40	36,0	29,0	00258190
BSP 1.1/2	11	45,0	140	40	36,0	29,0	00258200
BSP 1.5/8	11	49,6	140	40	36,0	29,0	00258210
BSP 1.3/4	11	51,0	140	40	40,0	32,0	00258220
BSP 2	11	57,0	160	40	45,0	35,0	00258240

МАШИННО РУЧНОЙ МЕТЧИК LH



ТЕХНИЧЕСКАЯ ИНФОРМАЦИЯ

Норма	DIN 5157	Вид отверстия	Сквозное / глухое
Резьба	BSP	Направление	левый
Материал	HSS-G	Класс точности	6h
Форма	Форма С	Обр. Материал	Сталь

Машинно-ручной метчик, однопроходный, 2-3 витка резьбы

Сечение	М	М	М	М	М	М	Арт.-Нр.
BSP 1/8	28	8,8	63	20	7,0	5,5	00259030
BSP 1/4	19	11,8	70	22	11,0	9,0	00259070
BSP 3/8	19	15,3	70	22	12,0	9,0	00259090
BSP 1/2	14	19,0	80	22	16,0	12,0	00259110
BSP 5/8	14	21,0	80	22	18,0	14,5	00259130
BSP 3/4	14	24,5	90	22	20,0	16,0	00259140
BSP 7/8	14	28,3	90	22	22,0	18,0	00259150
BSP 1	11	30,5	100	25	25,0	20,0	00259160
BSP 1.1/8	11	35,5	125	40	28,0	22,0	00259170
BSP 1.1/4	11	39,5	125	40	32,0	24,0	00259180
BSP 1.3/8	11	42,0	125	40	36,0	29,0	00259190
BSP 1.1/2	11	45,0	140	40	36,0	29,0	00259200
BSP 1.5/8	11	49,6	140	40	36,0	29,0	00259210
BSP 1.3/4	11	51,0	140	40	40,0	32,0	00259220
BSP 2	11	57,0	160	40	45,0	35,0	00259240

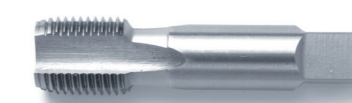

МАШИННО РУЧНОЙ МЕТЧИК



ТЕХНИЧЕСКАЯ ИНФОРМАЦИЯ

Норма	DIN 2184-2	Вид отверстия	Сквозное / глухое
Резьба	BSF	Направление	правый
Материал	HSS-G	Класс точности	6h
Форма	Форма С	Обр. Материал	Сталь

Машинно-ручной метчик, однопроходный, 2-3 витка резьбы

							Арт.-Нр.
BSF 1/4	26	5,2	56	19	6,0	4,9	00241060
BSF 5/16	22	6,6	63	22	6,0	4,9	00241070
BSF 3/8	20	8,1	70	24	7,0	5,5	00241080
BSF 7/16	18	9,5	70	24	7	5,5	00241090
BSF 1/2	16	11,0	75	28	9,0	7,0	00241100
BSF 9/16	16	12,5	80	30	11,0	9,0	00241110
BSF 5/8	14	14,0	80	32	12	9,0	00241120
BSF 3/4	12	16,75	95	34	14,0	11,0	00241140
BSF 7/8	11	19,7	100	34	18,0	14,5	00241160
BSF 1"	10	22,75	110	38	18,0	14,5	00241180

МАШИННО РУЧНОЙ МЕТЧИК

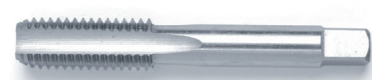

ТЕХНИЧЕСКАЯ ИНФОРМАЦИЯ

Норма	DIN 2184-2	Вид отверстия	Сквозное / глухое
Резьба	UNC	Направление	правый
Материал	HSS-G	Класс точности	6h
Форма	Форма С	Обр. Материал	Сталь

Машинно-ручной метчик, однопроходный, 2-3 витка резьбы

							Арт.-Нр.
UNC 1/4	20	5,2	56	19	6,0	4,9	00260130
UNC 5/16	18	6,6	63	22	6,0	4,9	00260140
UNC 3/8	16	8,0	70	24	7,0	5,5	00260150
UNC 7/16	14	9,4	70	24	7	5,5	00260160
UNC 1/2	13	10,8	75	28	9,0	7,0	00260170
UNC 9/16	12	12,3	80	30	11,0	9,0	00260180
UNC 5/8	11	13,5	80	32	12	9,0	00260190
UNC 3/4	10	16,5	95	34	14,0	11,0	00260210
UNC 7/8	9	19,5	100	34	18,0	14,5	00260230
UNC 1"	8	22,3	110	38	18,0	14,5	00260250

МАШИННО РУЧНОЙ МЕТЧИК



ТЕХНИЧЕСКАЯ ИНФОРМАЦИЯ

Норма	DIN 2184-2	Вид отверстия	Сквозное / глухое
Резьба	UNC	Направление	правый
Материал	HSS-G	Класс точности	6h
Форма	Форма D	Обр. Материал	Сталь

Машинно-ручной метчик, однопроходный, 4-5 витков резьбы

							Арт.-Нр.
UNC 1/4	20	5,2	56	19	6,0	4,9	00261130
UNC 5/16	18	6,6	63	22	6,0	4,9	00261140
UNC 3/8	16	8,0	70	24	7,0	5,5	00261150
UNC 7/16	14	9,4	70	24	7	5,5	00261160
UNC 1/2	13	10,8	75	28	9,0	7,0	00261170
UNC 9/16	12	12,3	80	30	11,0	9,0	00261180
UNC 5/8	11	13,5	80	32	12	9,0	00261190
UNC 3/4	10	16,5	95	34	14,0	11,0	00261210
UNC 7/8	9	19,5	100	34	18,0	14,5	00261230
UNC 1"	8	22,3	110	38	18,0	14,5	00261250

МАШИННО РУЧНОЙ МЕТЧИК



ТЕХНИЧЕСКАЯ ИНФОРМАЦИЯ

Норма	DIN 2184-2	Вид отверстия	Сквозное / глухое
Резьба	UNF	Направление	правый
Материал	HSS-G	Класс точности	6h
Форма	Форма С	Обр. Материал	Сталь

Машинно-ручной метчик, однопроходный, 2-3 витка резьбы

							Арт.-Нр.
UNF 1/4	28	5,5	50	16	6,0	4,9	00270130
UNF 5/16	24	6,9	56	16	6,0	4,9	00270140
UNF 3/8	24	8,5	56	16	7,0	5,5	00270150
UNF 7/16	20	9,9	63	18	8,0	6,2	00270160
UNF 9/16	18	13,0	70	22	11,0	9,0	00270180
UNF 5/8	18	14,5	70	22	12,0	9,0	00270190
UNF 3/4	16	17,5	80	25	14,0	11,0	00270210
UNF 7/8	14	20,5	90	28	18,0	14,5	00270230
UNF 1"	12	23,3	100	32	20,0	16,0	00270250

МАШИННО РУЧНОЙ МЕТЧИК



ТЕХНИЧЕСКАЯ ИНФОРМАЦИЯ

Норма	DIN 2184-2	Вид отверстия	Сквозное / глухое
Резьба	UNF	Направление	правый
Материал	HSS-G	Класс точности	6h
Форма	Форма D	Обр. Материал	Сталь

Машинно-ручной метчик, однопроходный, 4-5 витков резьбы

							Арт.-Нр.
UNF 1/4	28	5,5	50	16	6,0	4,9	00271130
UNF 5/16	24	6,9	56	16	6,0	4,9	00271140
UNF 3/8	24	8,5	56	16	7,0	5,5	00271150
UNF 7/16	20	9,9	63	18	8,0	6,2	00271160
UNF 9/16	18	13,0	70	22	11,0	9,0	00271180
UNF 5/8	18	14,5	70	22	12,0	9,0	00271190
UNF 3/4	16	17,5	80	25	14,0	11,0	00271210
UNF 7/8	14	20,5	90	28	18,0	14,5	00271230
UNF 1"	12	23,3	100	32	20,0	16,0	00271250

МАШИННО РУЧНОЙ МЕТЧИК



ТЕХНИЧЕСКАЯ ИНФОРМАЦИЯ

Норма	Заводской стандарт	Вид отверстия	Сквозное / глухое
Резьба	PG	Направление	правый
Материал	HSS-G	Класс точности	2b
Форма	Форма C	Обр. Материал	Сталь

Машинно-ручной метчик, однопроходный, 2-3 витка резьбы

							Арт.-Нр.
Pg 7	20	11,4	70	22	9	7	00287010
Pg 9	18	14,0	70	22	12	9	00287020
Pg 11	18	17,3	80	22	14	11	00287030
Pg 13,5	18	19,0	80	22	16	12	00287040
Pg 16	18	21,3	80	22	18	14,5	00287050
Pg 21	16	27,0	90	22	22	18	00287060
Pg 29	16	35,5	100	25	28	22	00287070
Pg 36	16	45,5	140	40	36	29	00287080
Pg 42	16	52,5	140	40	40	32	00287090
Pg 48	16	58,0	160	40	45	35	00287100

МАШИННО РУЧНОЙ МЕТЧИК



ТЕХНИЧЕСКАЯ ИНФОРМАЦИЯ

Норма	Заводской стандарт	Вид отверстия	Сквозное / глухое
Резьба	NPT	Направление	правый
Материал	HSS-G	Класс точности	6h
Форма	Форма C	Обр. Материал	Сталь

Машинно-ручной метчик, однопроходный, 2-3 витка резьбы

							Арт.-Нр.
NPT 1/16	27	6,25	55	13	7,0	5,5	00280010
NPT 1/8	27	8,5	63	15	7,0	5,5	00280020
NPT 1/4	18	11,1	63	21	11,0	9,0	00280030
NPT 3/8	18	14,7	70	21	12,0	9,0	00280040
NPT 1/2	14	18,0	80	27	16,0	12,0	00280050
NPT 3/4	14	23,3	100	27	20,0	16,0	00280060
NPT 1"	11,5	29,3	110	32	25,0	20,0	00280070
NPT 1.1/4	11,5	38,0	125	33	32,0	24,0	00280080
NPT 1.1/2	11,5	44,3	140	33	36,0	29,0	00280090
NPT 2"	11,5	56,3	160	33	36,0	29,0	00280100

МАШИННО РУЧНОЙ МЕТЧИК



ТЕХНИЧЕСКАЯ ИНФОРМАЦИЯ

Норма	Заводской стандарт	Вид отверстия	Сквозное / глухое
Резьба	NPT	Направление	lins
Материал	HSS-G	Класс точности	6h
Форма	Форма C	Обр. Материал	Сталь

Машинно-ручной метчик, однопроходный, 2-3 витка резьбы

							Арт.-Нр.
NPT 1/16	27	6,25	55	13	7,0	5,5	00284010
NPT 1/8	27	8,5	63	15	7,0	5,5	00284020
NPT 1/4	18	11,1	63	21	11,0	9,0	00284030
NPT 3/8	18	14,7	70	21	12,0	9,0	00284040
NPT 1/2	14	18,0	80	27	16,0	12,0	00284050
NPT 3/4	14	23,3	100	27	20,0	16,0	00284060
NPT 1"	11,5	29,3	110	32	25,0	20,0	00284070
NPT 1.1/4	11,5	38,0	125	33	32,0	24,0	00284080
NPT 1.1/2	11,5	44,3	140	33	36,0	29,0	00284090
NPT 2"	11,5	56,3	160	33	36,0	29,0	00284100

МАШИННО РУЧНОЙ МЕТЧИК



ТЕХНИЧЕСКАЯ ИНФОРМАЦИЯ

Норма	Заводской стандарт	Вид отверстия	Сквозное / глухое
Резьба	NPTF	Направление	правый
Материал	HSS-G	Класс точности	6h
Форма	Форма С	Обр. Материал	Сталь

Машинно-ручной метчик, однопроходный, 2-3 витка резьбы

							Арт.-Нр.
NPTF 1/16	27	6,25	55	13	7,0	5,5	00282010
NPTF 1/8	27	8,5	63	15	7,0	5,5	00282020
NPTF 1/4	18	11,1	63	21	11,0	9,0	00282030
NPTF 3/8	18	14,7	70	21	12,0	9,0	00282040
NPTF 1/2	14	18,0	80	27	16,0	12,0	00282050
NPTF 3/4	14	23,3	100	27	20,0	16,0	00282060
NPTF 1"	11,5	29,3	110	32	25,0	20,0	00282070
NPTF 1.1/4	11,5	38,0	125	33	32,0	24,0	00282080
NPTF 1.1/2	11,5	44,3	140	33	36,0	29,0	00282090
NPTF 2"	11,5	56,3	160	33	36,0	29,0	00282100

МАШИННО РУЧНОЙ МЕТЧИК



ТЕХНИЧЕСКАЯ ИНФОРМАЦИЯ

Норма	Заводской стандарт	Вид отверстия	Сквозное / глухое
Резьба	NPS	Направление	правый
Материал	HSSE-G	Класс точности	6h
Форма	Форма С	Обр. Материал	Сталь

Машинно-ручной метчик, однопроходный, 2-3 витка резьбы

							Арт.-Нр.
NPS 1/16	27	—	54	17,5	8,0	6,0	00289010
NPS 1/8	27	9,2	54	19	8,0	6,0	00289020
NPS 1/4	18	12,1	62	27	14,2	10,7	00289030
NPS 3/8	18	15,5	65	27	17,6	13,5	00289040
NPS 1/2	14	19,1	79	35	17,5	13,0	00289050
NPS 3/4	14	24,5	83	35	23,0	17,0	00289060
NPS 1"	11,5	30,6	95	44	28,8	21,4	00289070
NPS 1.1/4	11,5	—	105	45	32,0	26,0	00289080
NPS 1.1/2	11,5	—	110	45	38,0	29,0	00289090
NPS 2"	11,5	—	120	50	46,0	35,0	00289100

МАШИННО РУЧНОЙ МЕТЧИК



ТЕХНИЧЕСКАЯ ИНФОРМАЦИЯ

Норма	Заводской стандарт	Вид отверстия	сквозное < 1/2 x d
Резьба	NPS	Направление	правый
Материал	HSSE-G	Класс точности	6h
Форма	Форма С/RSP 35°	Обр. Материал	Сталь

Машинно-ручной метчик, однопроходный, 2-3 витка резьбы, со спиральной канавкой машинно ручной метчик-bit ts – Машинно ручной метчик-бит

							Арт.-Нр.
NPS 1/16	27	—	54	17,5	8,0	6,0	00290010
NPS 1/8	27	9,2	54	19	8,0	6,0	00290020
NPS 1/4	18	12,1	62	27	14,2	10,7	00290030
NPS 3/8	18	15,5	65	27	17,6	13,5	00290040
NPS 1/2	14	19,1	79	35	17,5	13,0	00290050
NPS 3/4	14	24,5	83	35	23,0	17,0	00290060
NPS 1"	11,5	30,6	95	44	28,8	21,4	00290070
NPS 1.1/4	11,5	—	105	45	32,0	26,0	00290080
NPS 1.1/2	11,5	—	110	45	38,0	29,0	00290090
NPS 2"	11,5	—	120	50	46,0	35,0	00290100

МАШИННО РУЧНОЙ МЕТЧИК-BITS



ТЕХНИЧЕСКАЯ ИНФОРМАЦИЯ

Норма	Заводской стандарт	Вид отверстия	Глухое < 1xd
Резьба	M	Направление	правый
Материал	HSS-G	Класс точности	6h
Форма	Форма А	Обр. Материал	Сталь

Метчик для аккумуляторных машин, 4-6 витков резьбы с шестигранным хвостовиком 1/4" (DIN 3126)

						Арт.-Нр.
M 3	0,5	2,5	33	11	1/4"	00299130
M 4	0,7	3,3	35	12	1/4"	00299150
M 5	0,8	4,2	36	15	1/4"	00299170
M 6	1	5	39	18	1/4"	00299190
M 8	1,25	6,8	40	19	1/4"	00299210
M 10	1,5	8,5	41	21	1/4"	00299230

РУЧНОЙ ГАЕЧНЫЙ МЕТЧИК



ТЕХНИЧЕСКАЯ ИНФОРМАЦИЯ

Норма	DIN 335	Вид отверстия	Глухое
Резьба	M	Направление	правый
Материал	HSS-G	Класс точности	ISO2 / 6h
Форма	2/3 x L2	Обр. Материал	Сталь

МАШИННЫЙ ГАЕЧНЫЙ МЕТЧИК



ТЕХНИЧЕСКАЯ ИНФОРМАЦИЯ

Норма	DIN 357	Вид отверстия	Глухое
Резьба	M	Направление	правый
Материал	HSSE-G	Класс точности	6h
Форма	2/3 x L2	Обр. Материал	Сталь

							Арт.-Нр.
M 3	0,5	2,5	70	45	2,2	2,7	00830130
M 4	0,7	3,3	90	55	2,8	3,4	00830150
M 5	0,8	4,2	100	60	3,5	4,9	00830170
M 6	1,0	5,0	110	65	4,5	4,9	00830190
M 8	1,25	6,8	125	72	6,0	4,9	00830210
M 10	1,5	8,5	140	80	7,0	5,5	00830230
M 12	1,75	10,2	180	90	9,0	7,0	00830250
M 14	2,0	12,0	200	95	11,0	9,0	00830260
M 16	2,0	14,0	200	105	12,0	9,0	00830270
M 18	2,5	15,5	220	115	14,0	11,0	00830280
M 20	2,5	17,5	250	120	16,0	12,0	00830290
M 22	2,5	19,5	280	125	18,0	14,5	00830300
M 24	3,0	21,0	280	130	18,0	14,5	00830310

							Арт.-Нр.
M 3	0,5	2,5	70	22	2,2	2,7	03399130
M 4	0,7	3,3	90	25	2,8	3,4	03399150
M 5	0,8	4,2	100	28	3,5	4,9	03399170
M 6	1,0	5,0	110	32	4,5	4,9	03399190
M 8	1,25	6,8	125	40	6,0	4,9	03399210
M 10	1,5	8,5	140	45	7,0	5,5	03399230
M 12	1,75	10,2	180	50	9,0	7,0	03399250
M 14	2,0	12,0	200	56	11,0	9,0	03399260
M 16	2,0	14,0	200	63	12,0	9,0	03399270
M 18	2,5	15,5	220	63	14,0	11,0	03399280
M 20	2,5	17,5	250	70	16,0	12,0	03399290
M 22	2,5	19,5	280	80	18,0	14,5	03399300
M 24	3,0	21,0	280	80	18,0	14,5	03399310
M 27	3,0	24,0	315	90	20,0	16,0	03399320
M 30	3,5	26,5	315	100	22,0	18,0	03399330
M 33	3,5	29,5	355	110	25,0	20,0	03399340
M 36	4,0	32,0	400	110	28,0	22,0	03399350
M 39	4,0	35,0	400	115	32,0	24,0	03399360
M 42	4,5	37,5	450	115	32,0	24,0	03399370
M 45	4,5	40,5	500	130	36,0	29,0	03399380
M 48	5,0	43,0	500	130	36,0	29,0	03399390
M 52	5,0	47,0	500	130	40,0	32,0	03399400

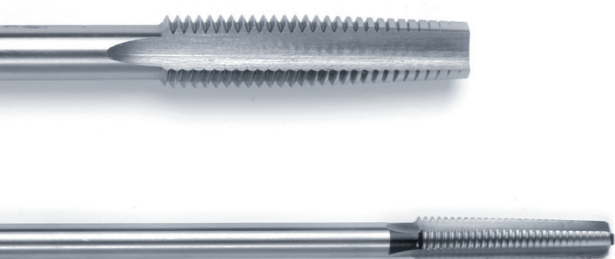

MASCHINEN-ГАЕЧНЫЙ МЕТЧИК

ТЕХНИЧЕСКАЯ ИНФОРМАЦИЯ



Норма	Заводской стандарт	Вид отверстия	Глухое < 1хd
Резьба	Tr	Направление	правый
Материал	HSS-G	Класс точности	7h
Форма	2/3 x L2	Обр. Материал	Сталь
с направляющей цапфой			

MASCHINEN-ГАЕЧНЫЙ МЕТЧИК LH

ТЕХНИЧЕСКАЯ ИНФОРМАЦИЯ



Норма	Заводской стандарт	Вид отверстия	Глухое < 1хd
Резьба	Tr	Направление	левый
Материал	HSS-G	Класс точности	7h
Форма	2/3 x L2	Обр. Материал	Сталь
с направляющей цапфой			

							Арт.-Нр.
Tr 10 × 2	2,0	8	110	63	7,0	5,5	00831010
Tr 10 × 3	3,0	7	125	75	7,0	5,5	00831020
Tr 12 × 3	3,0	9	165	111	8,0	6,2	00831040
Tr 14 × 3	3,0	11	140	85	10,0	8,0	00831060
Tr 14 × 4	4,0	10	170	112	10,0	8,0	00831070
Tr 16 × 4	4,0	12	180	116	11,0	9,0	00831090
Tr 18 × 4	4,0	14	190	120	12,0	9,0	00831110
Tr 20 × 4	4,0	16	200	124	14,0	11,0	00831130
Tr 22 × 5	5,0	17	235	155	16,0	12,0	00831140
Tr 24 × 5	5,0	19	245	160	18,0	14,5	00831160
Tr 26 × 5	5,0	21	255	165	20,0	16,0	00831170
Tr 28 × 5	5,0	23	265	170	22,0	18,0	00831180
Tr 30 × 6	6,0	24	290	185	22,0	18,0	00831200
Tr 32 × 6	6,0	26	300	191	25,0	20,0	00831210
Tr 36 × 6	6,0	30	310	200	28,0	22,0	00831230

							Арт.-Нр.
Tr 10 × 2	2,0	8	110	63	7,0	5,5	00832010
Tr 10 × 3	3,0	7	125	75	7,0	5,5	00832020
Tr 12 × 3	3,0	9	165	111	8,0	6,2	00832040
Tr 14 × 3	3,0	11	140	85	10,0	8,0	00832060
Tr 14 × 4	4,0	10	170	112	10,0	8,0	00832070
Tr 16 × 4	4,0	12	180	116	11,0	9,0	00832090
Tr 18 × 4	4,0	14	190	120	12,0	9,0	00832110
Tr 20 × 4	4,0	16	200	124	14,0	11,0	00832130
Tr 22 × 5	5,0	17	235	155	16,0	12,0	00832140
Tr 24 × 5	5,0	19	245	160	18,0	14,5	00832160
Tr 26 × 5	5,0	21	255	165	20,0	16,0	00832170
Tr 28 × 5	5,0	23	265	170	22,0	18,0	00832180
Tr 30 × 6	6,0	24	290	185	22,0	18,0	00832200
Tr 32 × 6	6,0	26	300	191	25,0	20,0	00832210
Tr 36 × 6	6,0	30	310	200	28,0	22,0	00832230

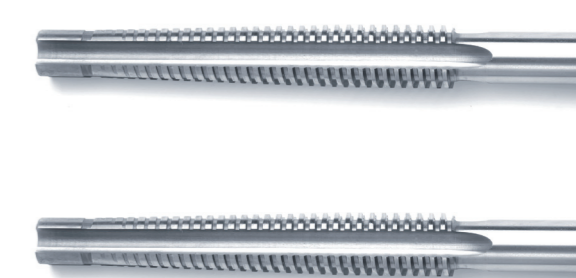

MASCHINEN-ГАЕЧНЫЙ МЕТЧИК

ТЕХНИЧЕСКАЯ ИНФОРМАЦИЯ



Норма	Заводской стандарт	Вид отверстия	Глухое < 1.1/2хd
Резьба	Tr	Направление	правый
Материал	HSSE-V3	Класс точности	7h
Форма	2/3 x L2	Обр. Материал	VA-Сталь
с направляющей цапфой			

							Арт.-Нр.
Tr 10 × 2	2,0	8,2	110	64	7,0	5,5	00292010
Tr 10 × 3	3,0	7,3	130	91	7,0	5,5	00292020
Tr 12 × 2	2,0	10,2	120	66	8,0	6,2	00292030
Tr 12 × 3	3,0	9,3	140	93	8,0	6,2	00292040
Tr 14 × 2	2,0	12,2	130	68	10,0	8,0	00292050
Tr 14 × 3	3,0	11,3	150	95	10,0	8,0	00292060
Tr 14 × 4	4,0	10,3	180	122	10,0	8,0	00292070
Tr 16 × 2	2,0	14,2	130	70	11,0	9,0	00292080
Tr 16 × 4	4,0	12,3	190	124	11,0	9,0	00292090
Tr 18 × 2	2,0	16,2	140	72	12,0	9,0	00292100
Tr 18 × 4	4,0	14,3	200	126	12,0	9,0	00292110
Tr 20 × 2	2,0	18,2	150	74	14,0	11,0	00292120
Tr 20 × 4	4,0	16,3	210	128	14,0	11,0	00292130
Tr 22 × 5	5,0	17,4	240	157	16,0	12,0	00292140
Tr 24 × 3	3,0	21,3	200	104	18,0	14,5	00292150
Tr 24 × 5	5,0	19,4	250	159	18,0	14,5	00292160
Tr 26 × 5	5,0	21,4	260	160	20,0	16,0	00292170
Tr 28 × 5	5,0	23,4	270	160	22,0	18,0	00292180
Tr 30 × 3	3,0	27,3	220	104	22,0	18,0	00292190
Tr 30 × 6	6,0	24,5	300	188	22,0	18,0	00292200
Tr 32 × 6	6,0	26,5	310	188	25,0	20,0	00292210
Tr 36 × 3	3,0	33,3	240	104	28,0	22,0	00292220
Tr 36 × 6	6,0	30,5	330	188	28,0	22,0	00292230
Tr 40 × 7	7,0	33,5	370	216	32,0	24,0	00292240

MASCHINEN-ГАЕЧНЫЙ МЕТЧИК LH

ТЕХНИЧЕСКАЯ ИНФОРМАЦИЯ



Норма	Заводской стандарт	Вид отверстия	Глухое < 1.1/2хd
Резьба	Tr	Направление	правый
Материал	HSSE-V3	Класс точности	7h
Форма	2/3 x L2	Обр. Материал	VA-Сталь
с направляющей цапфой			

							Арт.-Нр.
Tr 10 × 2	2,0	8,2	110	64	7,0	5,5	00293010
Tr 10 × 3	3,0	7,3	130	91	7,0	5,5	00293020
Tr 12 × 2	2,0	10,2	120	66	8,0	6,2	00293030
Tr 12 × 3	3,0	9,3	140	93	8,0	6,2	00293040
Tr 14 × 2	2,0	12,2	130	68	10,0	8,0	00293050
Tr 14 × 3	3,0	11,3	150	95	10,0	8,0	00293060
Tr 14 × 4	4,0	10,3	180	122	10,0	8,0	00293070
Tr 16 × 2	2,0	14,2	130	70	11,0	9,0	00293080
Tr 16 × 4	4,0	12,3	190	124	11,0	9,0	00293090
Tr 18 × 2	2,0	16,2	140	72	12,0	9,0	00293100
Tr 18 × 4	4,0	14,3	200	126	12,0	9,0	00293110
Tr 20 × 2	2,0	18,2	150	74	14,0	11,0	00293120
Tr 20 × 4	4,0	16,3	210	128	14,0	11,0	00293130
Tr 22 × 5	5,0	17,4	240	157	16,0	12,0	00293140
Tr 24 × 3	3,0	21,3	200	104	18,0	14,5	00293150
Tr 24 × 5	5,0	19,4	250	159	18,0	14,5	00293160
Tr 26 × 5	5,0	21,4	260	160	20,0	16,0	00293170
Tr 28 × 5	5,0	23,4	270	160	22,0	18,0	00293180
Tr 30 × 3	3,0	27,3	220	104	22,0	18,0	00293190
Tr 30 × 6	6,0	24,5	300	188	22,0	18,0	00293200
Tr 32 × 6	6,0	26,5	310	188	25,0	20,0	00293210
Tr 36 × 3	3,0	33,3	240	104	28,0	22,0	00293220
Tr 36 × 6	6,0	30,5	330	188	28,0	22,0	00293230
Tr 40 × 7	7,0	33,5	370	216	32,0	24,0	00293240

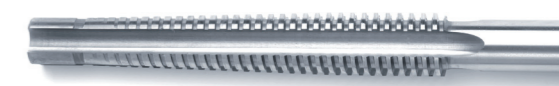

HSS-E

Быстрорежущая сталь группы сплавов HSS-E с содержанием кобальта и с долей ванадия $\leq 2,6\%$

HSS

Быстрорежущая сталь группы сплавов HSS без добавления кобальта с долей ванадия $>2,6\%$



▶ МАШИННЫЙ МЕТЧИК

DIN 371 / DIN 376

ТИП 2

DIN 376 / M3 – M10

ТИП 1

DIN 371 / M3,5 – M68



Машинный метчик применяется в машинах для нарезки внутренней резьбы. Метчики по DIN 371 имеют утолщенный хвостовик, ну а метчики по DIN 376 изготавливаются с проходным хвостовиком.

ТИП 1

DIN 371 / M1 – M2,6

ТИП 2

DIN 376 / M1,6 – M3

**МЕТЧИК
DIN 371 · B · M2 · 6H · HSS**
Обозначение

DIN 371 = Немецкий институт по стандартизации
B = винтовая подточка для сквозных отверстий по DIN 2191

M2 = размер в мм для метрических ISO2-резьб

6H = класс точности по DIN 802, часть 1

HSS = быстрорежущая сталь группы сплавов HSS

Маркировка в соответствии с DIN 2197
M2 6H HSS

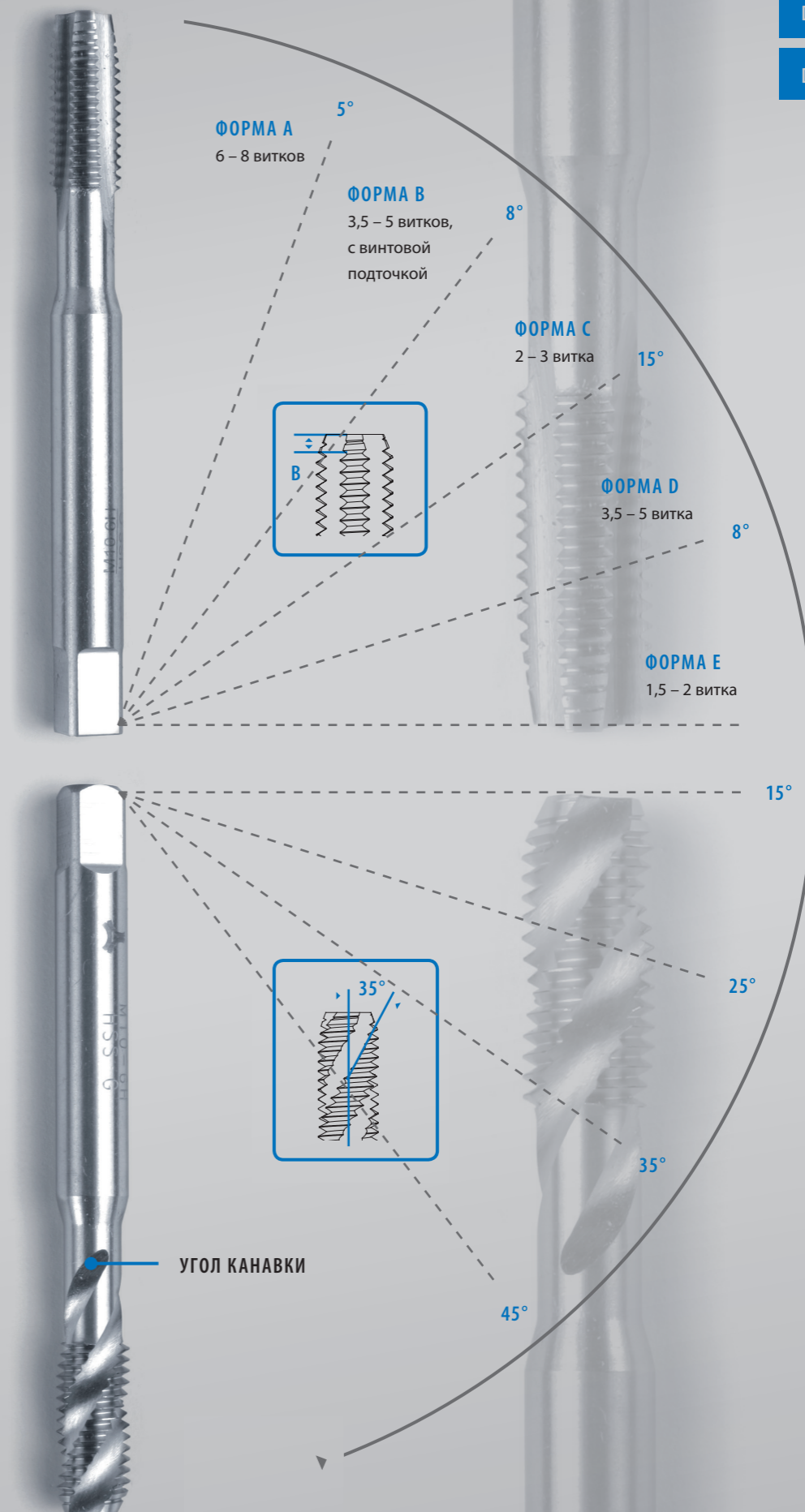

МАШИННЫЙ МЕТЧИК



ТЕХНИЧЕСКАЯ ИНФОРМАЦИЯ

Норма	DIN 371	Вид отверстия	сквозное < 1хd
Резьба	M	Направление	правый
Материал	HSS-G	Класс точности	6h
Форма	Форма А	Обр. Материал	Сталь

Машинный метчик с утолщённым хвостовиком, 6–8 Витков резьбы

М	мм	мм	мм	мм	мм	мм	Арт.-Нр.
M 2	0,4	1,6	45	8	2,8	2,1	00301080
M 2,2	0,45	1,75	45	9	2,8	2,1	00301090
M 2,3	0,4	1,9	45	9	2,8	2,1	00301100
M 2,5	0,45	2,05	50	9	2,8	2,1	00301110
M 2,6	0,45	2,1	50	9	2,8	2,1	00301120
M 3	0,5	2,5	56	11	3,5	2,7	00301130
M 3,5	0,6	2,9	56	12	4,0	3,0	00301140
M 4	0,7	3,3	63	13	4,5	3,4	00301150
M 5	0,8	4,2	70	16	6,0	4,9	00301170
M 6	1,0	5,0	80	19	6,0	4,9	00301190
M 7	1,0	6,0	80	19	7,0	5,5	00301200
M 8	1,25	6,8	90	22	8,0	6,2	00301210
M 10	1,5	8,5	100	24	10,0	8,0	00301230

МАШИННЫЙ МЕТЧИК



ТЕХНИЧЕСКАЯ ИНФОРМАЦИЯ

Норма	DIN 376	Вид отверстия	сквозное < 1хd
Резьба	M	Направление	правый
Материал	HSS-G	Класс точности	6h
Форма	Форма А	Обр. Материал	Сталь

Машинный метчик с проходным хвостовиком, 6–8 Витков резьбы

М	мм	мм	мм	мм	мм	мм	Арт.-Нр.
M 3	0,5	2,5	56	11	2,2	—	00307130
M 4	0,7	3,3	63	13	2,8	2,1	00307150
M 5	0,8	4,2	70	16	3,5	2,7	00307170
M 6	1,0	5,0	80	19	4,5	3,4	00307190
M 7	1,0	6,0	80	19	5,5	4,3	00307200
M 8	1,25	6,8	90	22	6,0	4,9	00307210
M 10	1,5	8,5	100	24	7,0	5,5	00307230
M 12	1,75	10,2	110	28	9,0	7,0	00307250
M 14	2,0	12,0	110	30	11,0	9,0	00307260
M 16	2,0	14,0	110	32	12,0	9,0	00307270
M 18	2,5	15,5	125	34	14,0	11,0	00307280
M 20	2,5	17,5	140	34	16,0	12,0	00307290

М	мм	мм	мм	мм	мм	мм	Арт.-Нр.
M 22	2,5	19,5	140	34	18,0	14,5	00307300
M 24	3,0	21,0	160	38	18,0	14,5	00307310
M 27	3,0	24,0	160	38	20,0	16,0	00307320
M 30	3,5	26,5	180	45	22,0	18,0	00307330
M 33	3,5	29,5	180	50	25,0	20,0	00307340
M 36	4,0	32,0	200	56	28,0	22,0	00307350
M 39	4,0	35,0	200	60	32,0	24,0	00307360
M 42	4,5	37,5	200	60	32,0	24,0	00307370
M 45	4,5	40,5	220	65	36,0	29,0	00307380
M 48	5,0	43,0	250	70	36,0	29,0	00307390
M 52	5,0	47,0	250	70	40,0	32,0	00307400
M 56	5,5	51,5	250	70	40,0	32,0	00307410
M 60	5,5	54,5	280	75	45,0	35,0	00307420
M 64	6,0	58,0	315	80	50,0	39,0	00307430
M 68	6,0	62,0	315	80	50,0	39,0	00307440
M 72	6,0	66,0	340	80	50,0	39,0	00307450
M 76	6,0	70,0	340	80	50,0	39,0	00307460
M 80	6,0	74,0	360	85	50,0	39,0	00307470
M 84	6,0	78,0	380	85	50,0	39,0	00307480
M 88	6,0	82,0	380	85	50,0	39,0	00307490
M 90	6,0	84,0	380	85	50,0	39,0	00307500
M 92	6,0	86,0	400	90	56,0	44,0	00307510
M 96	6,0	90,0	400	90	56,0	44,0	00307520
M 100	6,0	94,0	400	90	56,0	44,0	00307530

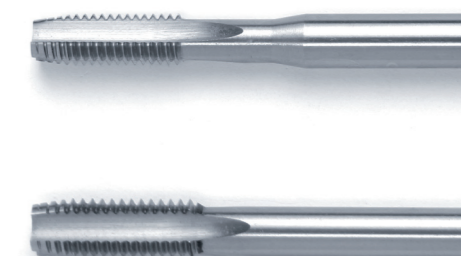

МАШИННЫЙ МЕТЧИК



ТЕХНИЧЕСКАЯ ИНФОРМАЦИЯ

Норма	DIN 371	Вид отверстия	сквозное < 1.1/2xd
Резьба	M	Направление	правый
Материал	HSSE-G	Класс точности	6h
Форма	Форма А	Обр. Материал	Сталь

Машинный метчик с утолщённым хвостовиком, 6–8 Витков резьбы, с прямой канавкой

Иконка	М	мм	мм	мм	мм	мм	Арт.-Нр.	
	M 2	0,4	1,6	45	8	2,8	2,1	01001080
	M 2,2	0,45	1,75	45	9	2,8	2,1	01001090
	M 2,3	0,4	1,9	45	9	2,8	2,1	01001100
	M 2,5	0,45	2,05	50	9	2,8	2,1	01001110
	M 2,6	0,45	2,1	50	9	2,8	2,1	01001120
	M 3	0,5	2,5	56	11	3,5	2,7	01001130
	M 3,5	0,6	2,9	56	12	4,0	3,0	01001140
	M 4	0,7	3,3	63	13	4,5	3,4	01001150
	M 5	0,8	4,2	70	16	6,0	4,9	01001170
	M 6	1,0	5,0	80	19	6,0	4,9	01001190
	M 7	1,0	6,0	80	19	7,0	5,5	01001200
	M 8	1,25	6,8	90	22	8,0	6,2	01001210
	M 10	1,5	8,5	100	24	10,0	8,0	01001230

МАШИННЫЙ МЕТЧИК



ТЕХНИЧЕСКАЯ ИНФОРМАЦИЯ

Норма	DIN 376	Вид отверстия	сквозное < 1.1/2xd
Резьба	M	Направление	правый
Материал	HSSE-G	Класс точности	6h
Форма	Форма А	Обр. Материал	Сталь

Машинный метчик с проходным хвостовиком, 6–8 Витков резьбы, с прямой канавкой

Иконка	М	мм	мм	мм	мм	мм	Арт.-Нр.	
	M 3	0,5	2,5	56	11	2,2	—	02001130
	M 4	0,7	3,3	63	13	2,8	2,1	02001150
	M 5	0,8	4,2	70	16	3,5	2,7	02001170
	M 6	1,0	5,0	80	19	4,5	3,4	02001190
	M 7	1,0	6,0	80	19	5,5	4,3	02001200
	M 8	1,25	6,8	90	22	6,0	4,9	02001210
	M 10	1,5	8,5	100	24	7,0	5,5	02001230
	M 12	1,75	10,2	110	28	9,0	7,0	02001250
	M 14	2,0	12,0	110	30	11,0	9,0	02001260
	M 16	2,0	14,0	110	32	12,0	9,0	02001270
	M 18	2,5	15,5	125	34	14,0	11,0	02001280
	M 20	2,5	17,5	140	34	16,0	12,0	02001290
	M 22	2,5	19,5	140	34	18,0	14,5	02001300
	M 24	3,0	21,0	160	38	18,0	14,5	02001310
	M 27	3,0	24,0	160	38	20,0	16,0	02001320
	M 30	3,5	26,5	180	45	22,0	18,0	02001330
	M 33	3,5	29,5	180	50	25,0	20,0	02001340
	M 36	4,0	32,0	200	56	28,0	22,0	02001350
	M 39	4,0	35,0	200	60	32,0	24,0	02001360
	M 42	4,5	37,5	200	60	32,0	24,0	02001370
	M 45	4,5	40,5	220	65	36,0	29,0	02001380
	M 48	5,0	43,0	250	70	36,0	29,0	02001390
	M 52	5,0	47,0	250	70	40,0	32,0	02001400
	M 56	5,5	51,5	250	70	40,0	32,0	02001410
	M 60	5,5	54,5	280	75	45,0	35,0	02001420
	M 64	6,0	58,0	315	80	50,0	39,0	02001430
	M 68	6,0	62,0	315	80	50,0	39,0	02001440
	M 72	6,0	66,0	340	80	50,0	39,0	02001450
	M 76	6,0	70,0	340	80	50,0	39,0	02001460
	M 80	6,0	74,0	360	85	50,0	39,0	02001470
	M 84	6,0	78,0	380	85	50,0	39,0	02001480
	M 88	6,0	82,0	380	85	50,0	39,0	02001490
	M 90	6,0	84,0	380	85	50,0	39,0	02001500
	M 92	6,0	86,0	400	90	56,0	44,0	02001510
	M 96	6,0	90,0	400	90	56,0	44,0	02001520
	M 100	6,0	94,0	400	90	56,0	44,0	02001530

МАШИННЫЙ МЕТЧИК



ТЕХНИЧЕСКАЯ ИНФОРМАЦИЯ

Норма	DIN 371	Вид отверстия	сквозное < 1.1/2xd
Резьба	M	Направление	правый
Материал	HSS-G	Класс точности	6h
Форма	Форма В	Обр. Материал	Сталь

Машинный метчик с утолщённым хвостовиком, 4–5 витков резьбы, со спиральной подточкой (стружколом)

Иконка	Иконка	Иконка	Иконка	Иконка	Иконка	Иконка	Арт.-Нр.
M 2	0,4	1,6	45	8	2,8	2,1	00302080
M 2,2	0,45	1,75	45	9	2,8	2,1	00302090
M 2,3	0,4	1,9	45	9	2,8	2,1	00302100
M 2,5	0,45	2,05	50	9	2,8	2,1	00302110
M 2,6	0,45	2,1	50	9	2,8	2,1	00302120
M 3	0,5	2,5	56	11	3,5	2,7	00302130
M 3,5	0,6	2,9	56	12	4,0	3,0	00302140
M 4	0,7	3,3	63	13	4,5	3,4	00302150
M 5	0,8	4,2	70	16	6,0	4,9	00302170
M 6	1,0	5,0	80	19	6,0	4,9	00302190
M 7	1,0	6,0	80	19	7,0	5,5	00302200
M 8	1,25	6,8	90	22	8,0	6,2	00302210
M 10	1,5	8,5	100	24	10,0	8,0	00302230

МАШИННЫЙ МЕТЧИК



ТЕХНИЧЕСКАЯ ИНФОРМАЦИЯ

Норма	DIN 376 (DIN 2184-1)	Вид отверстия	сквозное < 1.1/2xd
Резьба	M	Направление	правый
Материал	HSS-G	Класс точности	6h
Форма	Форма В	Обр. Материал	Сталь

Машинный метчик с проходным хвостовиком, 4 – 5 витков резьбы, со спиральной подточкой (стружколом)

Иконка	Иконка	Иконка	Иконка	Иконка	Иконка	Иконка	Арт.-Нр.
M 3	0,5	2,5	56	11	2,2	—	00309130
M 4	0,7	3,3	63	13	2,8	2,1	00309150
M 5	0,8	4,2	70	16	3,5	2,7	00309170
M 6	1,0	5,0	80	19	4,5	3,4	00309190
M 7	1,0	6,0	80	19	5,5	4,3	00309200
M 8	1,25	6,8	90	22	6,0	4,9	00309210
M 10	1,5	8,5	100	24	7,0	5,5	00309230
M 12	1,75	10,2	110	28	9,0	7,0	00309250
M 14	2,0	12,0	110	30	11,0	9,0	00309260
M 16	2,0	14,0	110	32	12,0	9,0	00309270

Иконка	Иконка	Иконка	Иконка	Иконка	Иконка	Иконка	Арт.-Нр.
M 18	2,5	15,5	125	34	14,0	11,0	00309280
M 20	2,5	17,5	140	34	16,0	12,0	00309290
M 22	2,5	19,5	140	34	18,0	14,5	00309300
M 24	3,0	21,0	160	38	18,0	14,5	00309310
M 27	3,0	24,0	160	38	20,0	16,0	00309320
M 30	3,5	26,5	180	45	22,0	18,0	00309330
M 33	3,5	29,5	180	50	25,0	20,0	00309340
M 36	4,0	32,0	200	56	28,0	22,0	00309350
M 39	4,0	35,0	200	60	32,0	24,0	00309360
M 42	4,5	37,5	200	60	32,0	24,0	00309370
M 45	4,5	40,5	220	65	36,0	29,0	00309380
M 48	5,0	43,0	250	70	36,0	29,0	00309390
M 52	5,0	47,0	250	70	40,0	32,0	00309400
M 56	5,5	51,5	250	70	40,0	32,0	00309410
M 60	5,5	54,5	280	75	45,0	35,0	00309420
M 64	6,0	58,0	315	80	50,0	39,0	00309430
M 68	6,0	62,0	315	80	50,0	39,0	00309440
M 72	6,0	66,0	340	80	50,0	39,0	00309450
M 76	6,0	70,0	340	80	50,0	39,0	00309460
M 80	6,0	74,0	360	85	50,0	39,0	00309470
M 84	6,0	78,0	380	85	50,0	39,0	00309480
M 88	6,0	82,0	380	85	50,0	39,0	00309490
M 90	6,0	84,0	380	85	50,0	39,0	00309500
M 92	6,0	86,0	400	90	56,0	44,0	00309510
M 96	6,0	90,0	400	90	56,0	44,0	00309520
M 100	6,0	94,0	400	90	56,0	44,0	00309530

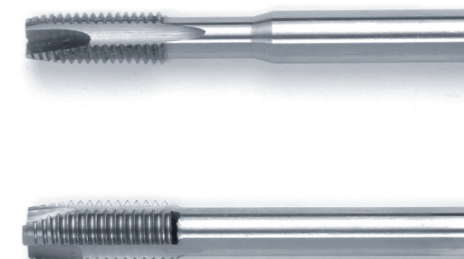

МАШИННЫЙ МЕТЧИК



ТЕХНИЧЕСКАЯ ИНФОРМАЦИЯ

Норма	DIN 371 (DIN 2184-1)	Вид отверстия	сквозное < 1.1/2xd
Резьба	M	Направление	правый
Материал	HSSE-G	Класс точности	6h
Форма	Форма B	Обр. Материал	Сталь

Машинный метчик с утолщённым хвостовиком, 4–5 витков резьбы, со спиральной подточкой (стружколом)

Иконка	Иконка	Иконка	Иконка	Иконка	Иконка	Иконка	Арт.-Нр.
M 2	0,4	1,6	45	8	2,8	2,1	01004080
M 2,2	0,45	1,75	45	9	2,8	2,1	01004090
M 2,3	0,4	1,9	45	9	2,8	2,1	01004100
M 2,5	0,45	2,05	50	9	2,8	2,1	01004110
M 2,6	0,45	2,1	50	9	2,8	2,1	01004120
M 3	0,5	2,5	56	11	3,5	2,7	01004130
M 3,5	0,6	2,9	56	12	4,0	3,0	01004140
M 4	0,7	3,3	63	13	4,5	3,4	01004150
M 5	0,8	4,2	70	16	6,0	4,9	01004170
M 6	1,0	5,0	80	19	6,0	4,9	01004190
M 7	1,0	6,0	80	19	7,0	5,5	01004200
M 8	1,25	6,8	90	22	8,0	6,2	01004210
M 10	1,5	8,5	100	24	10,0	8,0	01004230

МАШИННЫЙ МЕТЧИК



ТЕХНИЧЕСКАЯ ИНФОРМАЦИЯ

Норма	DIN 376	Вид отверстия	сквозное < 1.1/2xd
Резьба	M	Направление	правый
Материал	HSSE-G	Класс точности	6h
Форма	Форма B	Обр. Материал	Сталь

Машинный метчик с проходным хвостовиком, 4–5 витков резьбы, со спиральной подточкой (стружколом)

Иконка	Иконка	Иконка	Иконка	Иконка	Иконка	Иконка	Арт.-Нр.
M 3	0,5	2,5	56	11	2,2	—	02004130
M 4	0,7	3,3	63	13	2,8	2,1	02004150
M 5	0,8	4,2	70	16	3,5	2,7	02004170
M 6	1,0	5,0	80	19	4,5	3,4	02004190
M 7	1,0	6,0	80	19	5,5	4,3	02004200
M 8	1,25	6,8	90	22	6,0	4,9	02004210
M 10	1,5	8,5	100	24	7,0	5,5	02004230
M 12	1,75	10,2	110	28	9,0	7,0	02004250
M 14	2,0	12,0	110	30	11,0	9,0	02004260
M 16	2,0	14,0	110	32	12,0	9,0	02004270
M 18	2,5	15,5	125	34	14,0	11,0	02004280
M 20	2,5	17,5	140	34	16,0	12,0	02004290
M 22	2,5	19,5	140	34	18,0	14,5	02004300
M 24	3,0	21,0	160	38	18,0	14,5	02004310
M 27	3,0	24,0	160	38	20,0	16,0	02004320
M 30	3,5	26,5	180	45	22,0	18,0	02004330
M 33	3,5	29,5	180	50	25,0	20,0	02004340
M 36	4,0	32,0	200	56	28,0	22,0	02004350
M 39	4,0	35,0	200	60	32,0	24,0	02004360
M 42	4,5	37,5	200	60	32,0	24,0	02004370
M 45	4,5	40,5	220	65	36,0	29,0	02004380
M 48	5,0	43,0	250	70	36,0	29,0	02004390
M 52	5,0	47,0	250	70	40,0	32,0	02004400
M 56	5,5	51,5	250	70	40,0	32,0	02004410
M 60	5,5	54,5	280	75	45,0	35,0	02004420
M 64	6,0	58,0	315	80	50,0	39,0	02004430
M 68	6,0	62,0	315	80	50,0	39,0	02004440
M 72	6,0	66,0	340	80	50,0	39,0	02004450
M 76	6,0	70,0	340	80	50,0	39,0	02004460
M 80	6,0	74,0	360	85	50,0	39,0	02004470
M 84	6,0	78,0	380	85	50,0	39,0	02004480
M 88	6,0	82,0	380	85	50,0	39,0	02004490
M 90	6,0	84,0	380	85	50,0	39,0	02004500
M 92	6,0	86,0	400	90	56,0	44,0	02004510
M 96	6,0	90,0	400	90	56,0	44,0	02004520
M 100	6,0	94,0	400	90	56,0	44,0	02004530

МАШИННЫЙ МЕТЧИК



ТЕХНИЧЕСКАЯ ИНФОРМАЦИЯ

Норма	DIN 371	Вид отверстия	сквозное < 1.1/2xd
Резьба	M	Направление	правый
Материал	HSSE-G / VAP	Класс точности	6h
Форма	Форма B	Обр. Материал	Сталь

Машинный метчик с утолщённым хвостовиком, 4–5 витков резьбы, со спиральной подточкой (стружколом)

							Арт.-Нр.
M 2	0,4	1,6	45	8	2,8	2,1	01005080
M 2,2	0,45	1,75	45	9	2,8	2,1	01005090
M 2,3	0,4	1,9	45	9	2,8	2,1	01005100
M 2,5	0,45	2,05	50	9	2,8	2,1	01005110
M 2,6	0,45	2,1	50	9	2,8	2,1	01005120
M 3	0,5	2,5	56	11	3,5	2,7	01005130
M 3,5	0,6	2,9	56	12	4,0	3,0	01005140
M 4	0,7	3,3	63	13	4,5	3,4	01005150
M 5	0,8	4,2	70	16	6,0	4,9	01005170
M 6	1,0	5,0	80	19	6,0	4,9	01005190
M 7	1,0	6,0	80	19	7,0	5,5	01005200
M 8	1,25	6,8	90	22	8,0	6,2	01005210
M 10	1,5	8,5	100	24	10,0	8,0	01005230

МАШИННЫЙ МЕТЧИК



ТЕХНИЧЕСКАЯ ИНФОРМАЦИЯ

Норма	DIN 376	Вид отверстия	сквозное < 1.1/2xd
Резьба	M	Направление	правый
Материал	HSSE-G / VAP	Класс точности	6h
Форма	Форма B	Обр. Материал	Сталь

Машинный метчик с проходным хвостовиком, 4–5 витков резьбы, со спиральной подточкой (стружколом)

							Арт.-Нр.
M 3	0,5	2,5	56	11	2,2	—	02005130
M 4	0,7	3,3	63	13	2,8	2,1	02005150
M 5	0,8	4,2	70	16	3,5	2,7	02005170
M 6	1,0	5,0	80	19	4,5	3,4	02005190
M 8	1,25	6,8	90	22	6,0	4,9	02005210
M 10	1,5	8,5	100	24	7,0	5,5	02005230
M 12	1,75	10,2	110	28	9,0	7,0	02005250
M 14	2,0	12,0	110	30	11,0	9,0	02005260
M 16	2,0	14,0	110	32	12,0	9,0	02005270
M 18	2,5	15,5	125	34	14,0	11,0	02005280
M 20	2,5	17,5	140	34	16,0	12,0	02005290
M 22	2,5	19,5	140	34	18,0	14,5	02005300
M 24	3,0	21,0	160	38	18,0	14,5	02005310
M 27	3,0	24,0	160	38	20,0	16,0	02005320
M 30	3,5	26,5	180	45	22,0	18,0	02005330
M 33	3,5	29,5	180	50	25,0	20,0	02005340
M 36	4,0	32,0	200	56	28,0	22,0	02005350

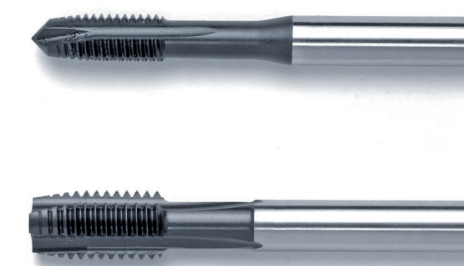

МАШИННЫЙ МЕТЧИК



ТЕХНИЧЕСКАЯ ИНФОРМАЦИЯ

Норма	DIN 371 (DIN 2184-1)	Вид отверстия	сквозное < 1.1/2xd
Резьба	M	Направление	правый
Материал	HSSE-G	Класс точности	6h
Форма	Форма В / AZ	Обр. Материал	Бронза, Медь, Алюминий

Машинный метчик с утолщённым хвостовиком, со спиральной подточкой (стружколом), шахматный

								Арт.-Нр.
M 2	0,4	1,6	45	8	2,8	2,1		01102080
M 2,2	0,45	1,75	45	9	2,8	2,1		01102090
M 2,3	0,4	1,9	45	9	2,8	2,1		01102100
M 2,5	0,45	2,05	50	9	2,8	2,1		01102110
M 2,6	0,45	2,1	50	9	2,8	2,1		01102120
M 3	0,5	2,5	56	11	3,5	2,7		01102130
M 3,5	0,6	2,9	56	12	4,0	3,0		01102140
M 4	0,7	3,3	63	13	4,5	3,4		01102150
M 5	0,8	4,2	70	16	6,0	4,9		01102170
M 6	1,0	5,0	80	19	6,0	4,9		01102190
M 7	1,0	6,0	80	19	7,0	5,5		01102200
M 8	1,25	6,8	90	22	8,0	6,2		01102210
M 10	1,5	8,5	100	24	10,0	8,0		01102230

МАШИННЫЙ МЕТЧИК



ТЕХНИЧЕСКАЯ ИНФОРМАЦИЯ

Норма	DIN 376	Вид отверстия	сквозное < 1.1/2xd
Резьба	M	Направление	правый
Материал	HSSE-G	Класс точности	6h
Форма	Форма В / AZ	Обр. Материал	Бронза, Медь, Алюминий

Машинный метчик с проходным хвостовиком, со спиральной подточкой (стружколом), шахматный

								Арт.-Нр.
M 12	1,75	10,2	110	28	9,0	7,0		02102250
M 14	2,0	12,0	110	30	11,0	9,0		02102260
M 16	2,0	14,0	110	32	12,0	9,0		02102270
M 18	2,5	15,5	125	34	14,0	11,0		02102280
M 20	2,5	17,5	140	34	16,0	12,0		02102290
M 22	2,5	19,5	140	34	18,0	14,5		02102300
M 24	3,0	21,0	160	38	18,0	14,5		02102310
M 27	3,0	24,0	160	38	20,0	16,0		02102320
M 30	3,5	26,5	180	45	22,0	18,0		02102330
M 33	3,5	29,5	180	50	25,0	20,0		02102340
M 36	4,0	32,0	200	56	28,0	22,0		02102350

МАШИННЫЙ МЕТЧИК



ТЕХНИЧЕСКАЯ ИНФОРМАЦИЯ

Норма	DIN 371	Вид отверстия	сквозное < 1.1/2xd
Резьба	M	Направление	правый
Материал	HSSE-G / TIN	Класс точности	6h
Форма	Форма В / TIN	Обр. Материал	Сталь

Машинный метчик с утолщённым хвостовиком, 4–5 Витков резьбы, нитрид титана, со спиральной подточкой (стружколом)

								Арт.-Нр.
M 2	0,4	1,6	45	8	2,8	2,1		01105080
M 2,2	0,45	1,75	45	9	2,8	2,1		01105090
M 2,3	0,4	1,9	45	9	2,8	2,1		01105100
M 2,5	0,45	2,05	50	9	2,8	2,1		01105110
M 2,6	0,45	2,1	50	9	2,8	2,1		01105120
M 3	0,5	2,5	56	11	3,5	2,7		01105130
M 3,5	0,6	2,9	56	12	4,0	3,0		01105140
M 4	0,7	3,3	63	13	4,5	3,4		01105150
M 5	0,8	4,2	70	16	6,0	4,9		01105170
M 6	1,0	5,0	80	19	6,0	4,9		01105190
M 7	1,0	6,0	80	19	7,0	5,5		01105200
M 8	1,25	6,8	90	22	8,0	6,2		01105210
M 10	1,5	8,5	100	24	10,0	8,0		01105230

МАШИННЫЙ МЕТЧИК



ТЕХНИЧЕСКАЯ ИНФОРМАЦИЯ

Норма	DIN 376	Вид отверстия	сквозное < 1.1/2xd
Резьба	M	Направление	правый
Материал	HSSE-G / TIN	Класс точности	6h
Форма	Форма В / TIN	Обр. Материал	Сталь

Машинный метчик с проходным хвостовиком, 4–5 Витков резьбы, нитрид титана, со спиральной подточкой (стружколом)

								Арт.-Нр.
M 12	1,75	10,2	110	28	9,0	7,0		02105250
M 14	2,0	12,0	110	30	11,0	9,0		02105260
M 16	2,0	14,0	110	32	12,0	9,0		02105270
M 18	2,5	15,5	125	34	14,0	11,0		02105290
M 20	2,5	17,5	140	34	16,0	12,0		02105300
M 22	2,5	19,5	140	34	18,0	14,5		02105310
M 24	3,0	21,0	160	38	18,0	14,5		02105320
M 27	3,0	24,0	160	38	20,0	16,0		02105330
M 30	3,5	26,5	180	45	22,0	18,0		02105340
M 33	3,5	29,5	180	50	25,0	20,0		02105350
M 36	4,0	32,0	200	56	28,0	22,0		02105360

МАШИННЫЙ МЕТЧИК



ТЕХНИЧЕСКАЯ ИНФОРМАЦИЯ

Норма	DIN 371 (DIN 2184-1)	Вид отверстия	сквозное / глухое < 1.1/2xd
Резьба	M	Направление	правый
Материал	HSS-G	Класс точности	6h
Форма	Форма С	Обр. Материал	Сталь

Машинный метчик с утолщённым хвостовиком, 2-3 витка резьбы, с прямой канавкой

							Арт.-Нр.
M 2	0,4	1,6	45	8	2,8	2,1	00326080
M 2,2	0,45	1,75	45	9	2,8	2,1	00326090
M 2,3	0,4	1,9	45	9	2,8	2,1	00326100
M 2,5	0,45	2,05	50	9	2,8	2,1	00326110
M 2,6	0,45	2,1	50	9	2,8	2,1	00326120
M 3	0,5	2,5	56	11	3,5	2,7	00326130
M 3,5	0,6	2,9	56	12	4,0	3,0	00326140
M 4	0,7	3,3	63	13	4,5	3,4	00326150
M 5	0,8	4,2	70	16	6,0	4,9	00326170
M 6	1,0	5,0	80	19	6,0	4,9	00326190
M 7	1,0	6,0	80	19	7,0	5,5	00326200
M 8	1,25	6,8	90	22	8,0	6,2	00326210
M 10	1,5	8,5	100	24	10,0	8,0	00326230

МАШИННЫЙ МЕТЧИК



ТЕХНИЧЕСКАЯ ИНФОРМАЦИЯ

Норма	DIN 376 (DIN 2184-1)	Вид отверстия	сквозное / глухое < 1.1/2xd
Резьба	M	Направление	правый
Материал	HSS-G	Класс точности	6h
Форма	Форма С	Обр. Материал	Сталь

Машинный метчик с проходным хвостовиком, 2-3 витка резьбы, с прямой канавкой

							Арт.-Нр.
M 3	0,5	2,5	56	11	2,2	—	00308130
M 4	0,7	3,3	63	13	2,8	2,1	00308150
M 5	0,8	4,2	70	16	3,5	2,7	00308170
M 6	1,0	5,0	80	19	4,5	3,4	00308190
M 7	1,0	6,0	80	19	5,5	4,3	00308200
M 8	1,25	6,8	90	22	6,0	4,9	00308210
M 10	1,5	8,5	100	24	7,0	5,5	00308230
M 12	1,75	10,2	110	28	9,0	7,0	00308250
M 14	2,0	12,0	110	30	11,0	9,0	00308260
M 16	2,0	14,0	110	32	12,0	9,0	00308270
M 18	2,5	15,5	125	34	14,0	11,0	00308280
M 20	2,5	17,5	140	34	16,0	12,0	00308290
M 22	2,5	19,5	140	34	18,0	14,5	00308300
M 24	3,0	21,0	160	38	18,0	14,5	00308310
M 27	3,0	24,0	160	38	20,0	16,0	00308320
M 30	3,5	26,5	180	45	22,0	18,0	00308330
M 33	3,5	29,5	180	50	25,0	20,0	00308340
M 36	4,0	32,0	200	56	28,0	22,0	00308350
M 39	4,0	35,0	200	60	32,0	24,0	00308360
M 42	4,5	37,5	200	60	32,0	24,0	00308370
M 45	4,5	40,5	220	65	36,0	29,0	00308380
M 48	5,0	43,0	250	70	36,0	29,0	00308390
M 52	5,0	47,0	250	70	40,0	32,0	00308400
M 56	5,5	51,5	250	70	40,0	32,0	00308410
M 60	5,5	54,5	280	75	45,0	35,0	00308420
M 64	6,0	58,0	315	80	50,0	39,0	00308430
M 68	6,0	62,0	315	80	50,0	39,0	00308440
M 72	6,0	66,0	340	80	50,0	39,0	00308450
M 76	6,0	70,0	340	80	50,0	39,0	00308460
M 80	6,0	74,0	360	85	50,0	39,0	00308470
M 84	6,0	78,0	380	85	50,0	39,0	00308480
M 88	6,0	82,0	380	85	50,0	39,0	00308490
M 90	6,0	84,0	380	85	50,0	39,0	00308500
M 92	6,0	86,0	400	90	56,0	44,0	00308510
M 96	6,0	90,0	400	90	56,0	44,0	00308520
M 100	6,0	94,0	400	90	56,0	44,0	00308530

МАШИННЫЙ МЕТЧИК



ТЕХНИЧЕСКАЯ ИНФОРМАЦИЯ

Норма	DIN 371	Вид отверстия	сквозное / глухое < 1.1/2хd
Резьба	M	Направление	правый
Материал	HSSE-G	Класс точности	6h
Форма	Форма С	Обр. Материал	Сталь, Messing

Машинный метчик с утолщённым хвостовиком, 2-3 витка резьбы, с прямой канавкой

М	М	М	М	М	М	М	Арт.-Нр.
M 2	0,4	1,6	45	8	2,8	2,1	01006080
M 2,2	0,45	1,75	45	9	2,8	2,1	01006090
M 2,3	0,4	1,9	45	9	2,8	2,1	01006100
M 2,5	0,45	2,05	50	9	2,8	2,1	01006110
M 2,6	0,45	2,1	50	9	2,8	2,1	01006120
M 3	0,5	2,5	56	11	3,5	2,7	01006130
M 3,5	0,6	2,9	56	12	4,0	3,0	01006140
M 4	0,7	3,3	63	13	4,5	3,4	01006150
M 5	0,8	4,2	70	16	6,0	4,9	01006170
M 6	1,0	5,0	80	19	6,0	4,9	01006190
M 7	1,0	6,0	80	19	7,0	5,5	01006200
M 8	1,25	6,8	90	22	8,0	6,2	01006210
M 10	1,5	8,5	100	24	10,0	8,0	01006220

МАШИННЫЙ МЕТЧИК



ТЕХНИЧЕСКАЯ ИНФОРМАЦИЯ

Норма	DIN 376	Вид отверстия	сквозное < 1.1/2хd
Резьба	M	Направление	правый
Материал	HSSE-G	Класс точности	6h
Форма	Форма С	Обр. Материал	Сталь, Messing

Машинный метчик с проходным хвостовиком, 2-3 витка резьбы, с прямой канавкой

М	М	М	М	М	М	М	Арт.-Нр.
M 3	0,5	2,5	56	11	2,2	—	02006170
M 4	0,7	3,3	63	13	2,8	2,1	02006180
M 5	0,8	4,2	70	16	3,5	2,7	02006190
M 6	1,0	5,0	80	19	4,5	3,4	02006200
M 7	1,0	6,0	80	19	5,5	4,3	02006210
M 8	1,25	6,8	90	22	6,0	4,9	02006220
M 10	1,5	8,5	100	24	7,0	5,5	02006230
M 12	1,75	10,2	110	28	9,0	7,0	02006250
M 14	2,0	12,0	110	30	11,0	9,0	02006260
M 16	2,0	14,0	110	32	12,0	9,0	02006270
M 18	2,5	15,5	125	34	14,0	11,0	02006280
M 20	2,5	17,5	140	34	16,0	12,0	02006290
M 22	2,5	19,5	140	34	18,0	14,5	02006300
M 24	3,0	21,0	160	38	18,0	14,5	02006310
M 27	3,0	24,0	160	38	20,0	16,0	02006320
M 30	3,5	26,5	180	45	22,0	18,0	02006330
M 33	3,5	29,5	180	50	25,0	20,0	02006340
M 36	4,0	32,0	200	56	28,0	22,0	02006350
M 39	4,0	35,0	200	60	32,0	24,0	02006360
M 42	4,5	37,5	200	60	32,0	24,0	02006370
M 45	4,5	40,5	220	65	36,0	29,0	02006380
M 48	5,0	43,0	250	70	36,0	29,0	02006390
M 52	5,0	47,0	250	70	40,0	32,0	02006400
M 56	5,5	51,5	250	70	40,0	32,0	02006410
M 60	5,5	54,5	280	75	45,0	35,0	02006420
M 64	6,0	58,0	315	80	50,0	39,0	02006430
M 68	6,0	62,0	315	80	50,0	39,0	02006440
M 72	6,0	66,0	340	80	50,0	39,0	02006450
M 76	6,0	70,0	340	80	50,0	39,0	02006460
M 80	6,0	74,0	360	85	50,0	39,0	02006470
M 84	6,0	78,0	380	85	50,0	39,0	02006480
M 88	6,0	82,0	380	85	50,0	39,0	02006490
M 90	6,0	84,0	380	85	50,0	39,0	02006500
M 92	6,0	86,0	400	90	56,0	44,0	02006510
M 96	6,0	90,0	400	90	56,0	44,0	02006520
M 100	6,0	94,0	400	90	56,0	44,0	02006530

МАШИННЫЙ МЕТЧИК



ТЕХНИЧЕСКАЯ ИНФОРМАЦИЯ

Норма	DIN 371	Вид отверстия	сквозное / глухое < 1.1/2xd
Резьба	M	Направление	правый
Материал	HSSE-G / VAP	Класс точности	6h
Форма	Форма С	Обр. Материал	VA-Сталь

Машинный метчик с утолщённым хвостовиком, 2-3 витка резьбы, с прямой канавкой, вакуумизированный

М	0,4	1,6	45	8	2,8	2,1	Арт.-Нр.
M 2	0,4	1,6	45	8	2,8	2,1	01116080
M 2,2	0,45	1,75	45	9	2,8	2,1	01116090
M 2,3	0,4	1,9	45	9	2,8	2,1	01116100
M 2,5	0,45	2,05	50	9	2,8	2,1	01116110
M 2,6	0,45	2,1	50	9	2,8	2,1	01116120
M 3	0,5	2,5	56	11	3,5	2,7	01116130
M 3,5	0,6	2,9	56	12	4,0	3,0	01116140
M 4	0,7	3,3	63	13	4,5	3,4	01116150
M 5	0,8	4,2	70	16	6,0	4,9	01116170
M 6	1,0	5,0	80	19	6,0	4,9	01116190
M 7	1,0	6,0	80	19	7,0	5,5	01116200
M 8	1,25	6,8	90	22	8,0	6,2	01116210
M 10	1,5	8,5	100	24	10,0	8,0	01116230

МАШИННЫЙ МЕТЧИК



ТЕХНИЧЕСКАЯ ИНФОРМАЦИЯ

Норма	DIN 376	Вид отверстия	сквозное / глухое < 1.1/2xd
Резьба	M	Направление	правый
Материал	HSSE-G / VAP	Класс точности	6h
Форма	Форма С	Обр. Материал	VA-Сталь

Машинный метчик с проходным хвостовиком, 2-3 витка резьбы, с прямой канавкой, вакуумизированный

М	1,75	10,2	110	28	9,0	7,0	Арт.-Нр.
M 12	1,75	10,2	110	28	9,0	7,0	02116250
M 14	2,0	12,0	110	30	11,0	9,0	02116260
M 16	2,0	14,0	110	32	12,0	9,0	02116270
M 18	2,5	15,5	125	34	14,0	11,0	02116280
M 20	2,5	17,5	140	34	16,0	12,0	02116290
M 22	2,5	19,5	140	34	18,0	14,5	02116300
M 24	3,0	21,0	160	38	18,0	14,5	02116310
M 27	3,0	24,0	160	38	20,0	16,0	02116320
M 30	3,5	26,5	180	45	22,0	18,0	02116330
M 33	3,5	29,5	180	50	25,0	20,0	02116340
M 36	4,0	32,0	200	56	28,0	22,0	02116350

МАШИННЫЙ МЕТЧИК



ТЕХНИЧЕСКАЯ ИНФОРМАЦИЯ

Норма	DIN 371	Вид отверстия	сквозное / глухое < 1.1/2xd
Резьба	M	Направление	правый
Материал	HSSE-G / TiN	Класс точности	6h
Форма	Форма С	Обр. Материал	Сталь

Машинный метчик с утолщённым хвостовиком, 2-3 витка резьбы, нитрид титана

М	0,4	1,6	45	8	2,8	2,1	Арт.-Нр.
M 2	0,4	1,6	45	8	2,8	2,1	01106080
M 2,2	0,45	1,75	45	9	2,8	2,1	01106090
M 2,3	0,4	1,9	45	9	2,8	2,1	01106100
M 2,5	0,45	2,05	50	9	2,8	2,1	01106110
M 2,6	0,45	2,1	50	9	2,8	2,1	01106120
M 3	0,5	2,5	56	11	3,5	2,7	01106130
M 3,5	0,6	2,9	56	12	4,0	3,0	01106140
M 4	0,7	3,3	63	13	4,5	3,4	01106150
M 5	0,8	4,2	70	16	6,0	4,9	01106170
M 6	1,0	5,0	80	19	6,0	4,9	01106190
M 7	1,0	6,0	80	19	7,0	5,5	01106200
M 8	1,25	6,8	90	22	8,0	6,2	01106210
M 10	1,5	8,5	100	24	10,0	8,0	01106230

МАШИННЫЙ МЕТЧИК



ТЕХНИЧЕСКАЯ ИНФОРМАЦИЯ

Норма	DIN 376	Вид отверстия	сквозное / глухое < 1.1/2xd
Резьба	M	Направление	правый
Материал	HSSE-G / TiN	Класс точности	6h
Форма	Форма С	Обр. Материал	Сталь

Машинный метчик с проходным хвостовиком, 2 – 3 Витков резьбы, нитрид титана

М	1,75	10,2	110	28	9,0	7,0	Арт.-Нр.
M 12	1,75	10,2	110	28	9,0	7,0	02106250
M 14	2,0	12,0	110	30	11,0	9,0	02106260
M 16	2,0	14,0	110	32	12,0	9,0	02106270
M 18	2,5	15,5	125	34	14,0	11,0	02106280
M 20	2,5	17,5	140	34	16,0	12,0	02106290
M 22	2,5	19,5	140	34	18,0	14,5	02106300
M 24	3,0	21,0	160	38	18,0	14,5	02106310
M 27	3,0	24,0	160	38	20,0	16,0	02106320
M 30	3,5	26,5	180	45	22,0	18,0	02106330
M 33	3,5	29,5	180	50	25,0	20,0	02106340
M 36	4,0	32,0	200	56	28,0	22,0	02106350

МАШИННЫЙ МЕТЧИК



ТЕХНИЧЕСКАЯ ИНФОРМАЦИЯ

Норма	DIN 371 (DIN 2184-1)	Вид отверстия	глухое < 2хd
Резьба	M	Направление	правый
Материал	HSS-G	Класс точности	6h
Форма	Форма C / RSP 15°	Обр. Материал	Сталь

Машинный метчик с утолщённым хвостовиком, 2-3 витка резьбы, со спиральной канавкой 15 градусов

М	мм	мм	мм	мм	мм	мм	Арт.-Нр.
M 2	0,4	1,6	45	8	2,8	2,1	00305080
M 2,2	0,45	1,75	45	9	2,8	2,1	00305090
M 2,3	0,4	1,9	45	9	2,8	2,1	00305100
M 2,5	0,45	2,05	50	9	2,8	2,1	00305110
M 2,6	0,45	2,1	50	9	2,8	2,1	00305120
M 3	0,5	2,5	56	11	3,5	2,7	00305130
M 3,5	0,6	2,9	56	12	4,0	3,0	00305140
M 4	0,7	3,3	63	13	4,5	3,4	00305150
M 5	0,8	4,2	70	16	6,0	4,9	00305170
M 6	1,0	5,0	80	19	6,0	4,9	00305190
M 7	1,0	6,0	80	19	7,0	5,5	00305200
M 8	1,25	6,8	90	22	8,0	6,2	00305210
M 10	1,5	8,5	100	24	10,0	8,0	00305230

МАШИННЫЙ МЕТЧИК



ТЕХНИЧЕСКАЯ ИНФОРМАЦИЯ

Норма	DIN 376 (DIN 2184-1)	Вид отверстия	глухое < 2хd
Резьба	M	Направление	правый
Материал	HSS-G	Класс точности	6h
Форма	Форма C / RSP 15°	Обр. Материал	Сталь

Машинный метчик с проходным хвостовиком, 2-3 витка резьбы, со спиральной канавкой 15 градусов

М	мм	мм	мм	мм	мм	мм	Арт.-Нр.
M 3	0,5	2,5	56	11	2,2	—	00310130
M 4	0,7	3,3	63	13	2,8	2,1	00310150
M 5	0,8	4,2	70	16	3,5	2,7	00310170
M 6	1,0	5,0	80	19	4,5	3,4	00310190
M 7	1,0	6,0	80	19	5,5	4,3	00310200
M 8	1,25	6,8	90	22	6,0	4,9	00310210
M 10	1,5	8,5	100	24	7,0	5,5	00310230
M 12	1,75	10,2	110	28	9,0	7,0	00310250
M 14	2,0	12,0	110	30	11,0	9,0	00310260
M 16	2,0	14,0	110	32	12,0	9,0	00310270
M 18	2,5	15,5	125	34	14,0	11,0	00310280
M 20	2,5	17,5	140	34	16,0	12,0	00310290
M 22	2,5	19,5	140	34	18,0	14,5	00310300
M 24	3,0	21,0	160	38	18,0	14,5	00310310
M 27	3,0	24,0	160	38	20,0	16,0	00310320
M 30	3,5	26,5	180	45	22,0	18,0	00310330
M 33	3,5	29,5	180	50	25,0	20,0	00310340
M 36	4,0	32,0	200	56	28,0	22,0	00310350
M 39	4,0	35,0	200	60	32,0	24,0	00310360
M 42	4,5	37,5	200	60	32,0	24,0	00310370
M 45	4,5	40,5	220	65	36,0	29,0	00310380
M 48	5,0	43,0	250	70	36,0	29,0	00310390
M 52	5,0	47,0	250	70	40,0	32,0	00310400
M 56	5,5	51,5	250	70	40,0	32,0	00310410
M 60	5,5	54,5	280	75	45,0	35,0	00310420
M 64	6,0	58,0	315	80	50,0	39,0	00310430
M 68	6,0	62,0	315	80	50,0	39,0	00310440
M 72	6,0	66,0	340	80	50,0	39,0	00310450
M 76	6,0	70,0	340	80	50,0	39,0	00310460
M 80	6,0	74,0	360	85	50,0	39,0	00310470
M 84	6,0	78,0	380	85	50,0	39,0	00310480
M 88	6,0	82,0	380	85	50,0	39,0	00310490
M 90	6,0	84,0	380	85	50,0	39,0	00310500
M 92	6,0	86,0	400	90	56,0	44,0	00310510
M 96	6,0	90,0	400	90	56,0	44,0	00310520
M 100	6,0	94,0	400	90	56,0	44,0	00310530



МАШИННЫЙ МЕТЧИК

ТЕХНИЧЕСКАЯ ИНФОРМАЦИЯ



Норма	DIN 371 (DIN 2184-1)	Вид отверстия	глухое < 2xd
Резьба	M	Направление	правый
Материал	HSSE-G	Класс точности	6h
Форма	Форма C / RSP 15°	Обр. Материал	Сталь

Машинный метчик с утолщённым хвостовиком, 2-3 витка резьбы, со спиральной канавкой 15 градусов

М	0,4	1,6	45	8	2,8	2,1	Арт.-Нр.
M 2	0,4	1,6	45	8	2,8	2,1	01013080
M 2,2	0,45	1,75	45	9	2,8	2,1	01013090
M 2,3	0,4	1,9	45	9	2,8	2,1	01013100
M 2,5	0,45	2,05	50	9	2,8	2,1	01013110
M 2,6	0,45	2,1	50	9	2,8	2,1	01013120
M 3	0,5	2,5	56	11	3,5	2,7	01013130
M 3,5	0,6	2,9	56	12	4,0	3,0	01013140
M 4	0,7	3,3	63	13	4,5	3,4	01013150
M 5	0,8	4,2	70	16	6,0	4,9	01013170
M 6	1,0	5,0	80	19	6,0	4,9	01013190
M 7	1,0	6,0	80	19	7,0	5,5	01013200
M 8	1,25	6,8	90	22	8,0	6,2	01013210
M 10	1,5	8,5	100	24	10,0	8,0	01013230

МАШИННЫЙ МЕТЧИК

ТЕХНИЧЕСКАЯ ИНФОРМАЦИЯ



Норма	DIN 376 (DIN 2184-1)	Вид отверстия	глухое < 2xd
Резьба	M	Направление	правый
Материал	HSSE-G	Класс точности	6h
Форма	Форма C / RSP 15°	Обр. Материал	Сталь

Машинный метчик с проходным хвостовиком, 2-3 витка резьбы, со спиральной канавкой 15 градусов

М	0,5	2,5	56	11	2,2	—	Арт.-Нр.
M 3	0,5	2,5	56	11	2,2	—	02013130
M 4	0,7	3,3	63	13	2,8	2,1	02013150
M 5	0,8	4,2	70	16	3,5	2,7	02013170
M 6	1,0	5,0	80	19	4,5	3,4	02013190
M 7	1,0	6,0	80	19	5,5	4,3	02013200
M 8	1,25	6,8	90	22	6,0	4,9	02013210
M 10	1,5	8,5	100	24	7,0	5,5	02013230
M 12	1,75	10,2	110	28	9,0	7,0	02013250
M 14	2,0	12,0	110	30	11,0	9,0	02013260
M 16	2,0	14,0	110	32	12,0	9,0	02013270
M 18	2,5	15,5	125	34	14,0	11,0	02013280
M 20	2,5	17,5	140	34	16,0	12,0	02013290
M 22	2,5	19,5	140	34	18,0	14,5	02013300
M 24	3,0	21,0	160	38	18,0	14,5	02013310
M 27	3,0	24,0	160	38	20,0	16,0	02013320
M 30	3,5	26,5	180	45	22,0	18,0	02013330
M 33	3,5	29,5	180	50	25,0	20,0	02013340
M 36	4,0	32,0	200	56	28,0	22,0	02013350
M 39	4,0	35,0	200	60	32,0	24,0	02013360
M 42	4,5	37,5	200	60	32,0	24,0	02013370
M 45	4,5	40,5	220	65	36,0	29,0	02013380
M 48	5,0	43,0	250	70	36,0	29,0	02013390
M 52	5,0	47,0	250	70	40,0	32,0	02013400
M 56	5,5	51,5	250	70	40,0	32,0	02013410
M 60	5,5	54,5	280	75	45,0	35,0	02013420
M 64	6,0	58,0	315	80	50,0	39,0	02013430
M 68	6,0	62,0	315	80	50,0	39,0	02013440
M 72	6,0	66,0	340	80	50,0	39,0	02013450
M 76	6,0	70,0	340	80	50,0	39,0	02013460
M 80	6,0	74,0	360	85	50,0	39,0	02013470
M 84	6,0	78,0	380	85	50,0	39,0	02013480
M 88	6,0	82,0	380	85	50,0	39,0	02013490
M 90	6,0	84,0	380	85	50,0	39,0	02013500
M 92	6,0	86,0	400	90	56,0	44,0	02013510
M 96	6,0	90,0	400	90	56,0	44,0	02013520
M 100	6,0	94,0	400	90	56,0	44,0	02013530



МАШИННЫЙ МЕТЧИК



ТЕХНИЧЕСКАЯ ИНФОРМАЦИЯ

Норма	DIN 371 (DIN 2184-1)	Вид отверстия	глухое < 3хd
Резьба	M	Направление	правый
Материал	HSS-G	Класс точности	6h
Форма	Форма C / RSP 35°	Обр. Материал	Сталь

Машинный метчик с утолщённым хвостовиком, 2-3 витка резьбы, со спиральной канавкой 35 градусов

Иконка	М	Н	Н	М	М	М	Арт.-Нр.	
	M 2	0,4	1,6	45	8	2,8	2,1	00306080
	M 2,2	0,45	1,75	45	9	2,8	2,1	00306090
	M 2,3	0,4	1,9	45	9	2,8	2,1	00306100
	M 2,5	0,45	2,05	50	9	2,8	2,1	00306110
	M 2,6	0,45	2,1	50	9	2,8	2,1	00306120
	M 3	0,5	2,5	56	7	3,5	2,7	00306130
	M 3,5	0,6	2,9	56	7	4,0	3,0	00306140
	M 4	0,7	3,3	63	8	4,5	3,4	00306150
	M 5	0,8	4,2	70	10	6,0	4,9	00306170
	M 6	1,0	5,0	80	12	6,0	4,9	00306190
	M 7	1,0	6,0	80	12	7,0	5,5	00306200
	M 8	1,25	6,8	90	16	8,0	6,2	00306210
	M 10	1,5	8,5	100	16	10,0	8,0	00306230

МАШИННЫЙ МЕТЧИК



ТЕХНИЧЕСКАЯ ИНФОРМАЦИЯ

Норма	DIN 376 (DIN 2184-1)	Вид отверстия	глухое < 3хd
Резьба	M	Направление	правый
Материал	HSS-G	Класс точности	6h
Форма	Форма C / RSP 35°	Обр. Материал	Сталь

Машинный метчик с проходным хвостовиком, 2-3 витка резьбы, со спиральной канавкой 35 градусов

Иконка	М	Н	Н	М	М	М	Арт.-Нр.	
	M 3	0,5	2,5	56	7	2,2	—	00311130
	M 4	0,7	3,3	63	8	2,8	2,1	00311150
	M 5	0,8	4,2	70	10	3,5	2,7	00311170
	M 6	1,0	5,0	80	12	4,5	3,4	00311190
	M 7	1,0	6,0	80	12	5,5	4,3	00311200
	M 8	1,25	6,8	90	16	6,0	4,9	00311210
	M 10	1,5	8,5	100	16	7,0	5,5	00311230
	M 12	1,75	10,2	110	18	9,0	7,0	00311250
	M 14	2,0	12,0	110	20	11,0	9,0	00311260
	M 16	2,0	14,0	110	22	12,0	9,0	00311270
	M 18	2,5	15,5	125	25	14,0	11,0	00311280
	M 20	2,5	17,5	140	25	16,0	12,0	00311290
	M 22	2,5	19,5	140	25	18,0	14,5	00311300
	M 24	3,0	21,0	160	30	18,0	14,5	00311310
	M 27	3,0	24,0	160	30	20,0	16,0	00311320
	M 30	3,5	26,5	180	35	22,0	18,0	00311330
	M 33	3,5	29,5	180	35	25,0	20,0	00311340
	M 36	4,0	32,0	200	45	28,0	22,0	00311350
	M 39	4,0	35,0	200	45	32,0	24,0	00311360
	M 42	4,5	37,5	200	45	32,0	24,0	00311370
	M 45	4,5	40,5	220	50	36,0	29,0	00311380
	M 48	5,0	43,0	250	50	36,0	29,0	00311390
	M 52	5,0	47,0	250	55	40,0	32,0	00311400
	M 56	5,5	51,5	250	55	40,0	32,0	00311410
	M 60	5,5	54,5	280	55	45,0	35,0	00311420
	M 64	6,0	58,0	315	70	50,0	39,0	00311430
	M 68	6,0	62,0	315	70	50,0	39,0	00311440
	M 72	6,0	66,0	340	80	50,0	39,0	00311450
	M 76	6,0	70,0	340	80	50,0	39,0	00311460
	M 80	6,0	74,0	360	85	50,0	39,0	00311470
	M 84	6,0	78,0	380	85	50,0	39,0	00311480
	M 88	6,0	82,0	380	85	50,0	39,0	00311490
	M 90	6,0	84,0	380	85	50,0	39,0	00311500
	M 92	6,0	86,0	400	90	56,0	44,0	00311510
	M 96	6,0	90,0	400	90	56,0	44,0	00311520
	M 100	6,0	94,0	400	90	56,0	44,0	00311530

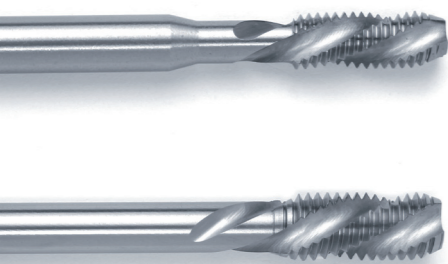

МАШИННЫЙ МЕТЧИК



ТЕХНИЧЕСКАЯ ИНФОРМАЦИЯ

Норма	DIN 371 (DIN 2184-1)	Вид отверстия	глухое < 3хd
Резьба	M	Направление	правый
Материал	HSSE-G	Класс точности	6h
Форма	Форма C / RSP 35°	Обр. Материал	Сталь

Машинный метчик с утолщённым хвостовиком, 2-3 витка резьбы, со спиральной канавкой 35 градусов

Иконка	М	мм	мм	мм	мм	мм	мм	Арт.-Нр.
	M 2	0,4	1,6	45	8	2,8	2,1	01015080
	M 2,2	0,45	1,75	45	9	2,8	2,1	01015090
	M 2,3	0,4	1,9	45	9	2,8	2,1	01015100
	M 2,5	0,45	2,05	50	9	2,8	2,1	01015110
	M 2,6	0,45	2,1	50	9	2,8	2,1	01015120
	M 3	0,5	2,5	56	7	3,5	2,7	01015130
	M 3,5	0,6	2,9	56	7	4,0	3,0	01015140
	M 4	0,7	3,3	63	8	4,5	3,4	01015150
	M 5	0,8	4,2	70	10	6,0	4,9	01015170
	M 6	1,0	5,0	80	12	6,0	4,9	01015190
	M 7	1,0	6,0	80	12	7,0	5,5	01015200
	M 8	1,25	6,8	90	16	8,0	6,2	01015210
	M 10	1,5	8,5	100	16	10,0	8,0	01015230

МАШИННЫЙ МЕТЧИК



ТЕХНИЧЕСКАЯ ИНФОРМАЦИЯ

Норма	DIN 376	Вид отверстия	глухое < 3хd
Резьба	M	Направление	правый
Материал	HSSE-G	Класс точности	6h
Форма	Форма C / RSP 35°	Обр. Материал	Сталь

Машинный метчик с проходным хвостовиком, 2-3 витка резьбы, со спиральной канавкой 35 градусов

Иконка	М	мм	мм	мм	мм	мм	мм	Арт.-Нр.
	M 3	0,5	2,5	56	7	2,2	—	02015130
	M 4	0,7	3,3	63	8	2,8	2,1	02015150
	M 5	0,8	4,2	70	10	3,5	2,7	02015170
	M 6	1,0	5,0	80	12	4,5	3,4	02015190
	M 7	1,0	6,0	80	12	5,5	4,3	02015200
	M 8	1,25	6,8	90	16	6,0	4,9	02015210
	M 10	1,5	8,5	100	16	7,0	5,5	02015230
	M 12	1,75	10,2	110	18	9,0	7,0	02015250
	M 14	2,0	12,0	110	20	11,0	9,0	02015260
	M 16	2,0	14,0	110	22	12,0	9,0	02015270
	M 18	2,5	15,5	125	25	14,0	11,0	02015280
	M 20	2,5	17,5	140	25	16,0	12,0	02015290
	M 22	2,5	19,5	140	25	18,0	14,5	02015300
	M 24	3,0	21,0	160	30	18,0	14,5	02015310
	M 27	3,0	24,0	160	30	20,0	16,0	02015320
	M 30	3,5	26,5	180	35	22,0	18,0	02015330
	M 33	3,5	29,5	180	35	25,0	20,0	02015340
	M 36	4,0	32,0	200	45	28,0	22,0	02015350
	M 39	4,0	35,0	200	45	32,0	24,0	02015360
	M 42	4,5	37,5	200	45	32,0	24,0	02015370
	M 45	4,5	40,5	220	50	36,0	29,0	02015380
	M 48	5,0	43,0	250	50	36,0	29,0	02015390
	M 52	5,0	47,0	250	55	40,0	32,0	02015400
	M 56	5,5	51,5	250	55	40,0	32,0	02015410
	M 60	5,5	54,5	280	55	45,0	35,0	02015420
	M 64	6,0	58,0	315	70	50,0	39,0	02015430
	M 68	6,0	62,0	315	70	50,0	39,0	02015440
	M 72	6,0	66,0	340	80	50,0	39,0	02015450
	M 76	6,0	70,0	340	80	50,0	39,0	02015460
	M 80	6,0	74,0	360	85	50,0	39,0	02015470
	M 84	6,0	78,0	380	85	50,0	39,0	02015480
	M 88	6,0	82,0	380	85	50,0	39,0	02015490
	M 90	6,0	84,0	380	85	50,0	39,0	02015500
	M 92	6,0	86,0	400	90	56,0	44,0	02015510
	M 96	6,0	90,0	400	90	56,0	44,0	02015520
	M 100	6,0	94,0	400	90	56,0	44,0	02015530

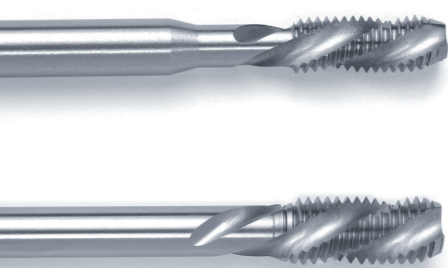

МАШИННЫЙ МЕТЧИК



ТЕХНИЧЕСКАЯ ИНФОРМАЦИЯ

Норма	DIN 371	Вид отверстия	глухое < 3хd
Резьба	M	Направление	правый
Материал	HSSE-G / VAP	Класс точности	6h
Форма	Форма C / RSP 35°	Обр. Материал	V2A-Сталь, Сталь > 70 кг/мм²

Машинный метчик с утолщённым хвостовиком, 2-3 витка резьбы, со спиральной канавкой 35 градусов

М	h	l	l ₁	l ₂	l ₃	α	Арт.-Нр.
M 2	0,4	1,6	45	8	2,8	2,1	01016080
M 2,2	0,45	1,75	45	9	2,8	2,1	01016090
M 2,3	0,4	1,9	45	9	2,8	2,1	01016100
M 2,5	0,45	2,05	50	9	2,8	2,1	01016110
M 2,6	0,45	2,1	50	9	2,8	2,1	01016120
M 3	0,5	2,5	56	7	3,5	2,7	01016130
M 3,5	0,6	2,9	56	7	4,0	3,0	01016140
M 4	0,7	3,3	63	8	4,5	3,4	01016150
M 5	0,8	4,2	70	10	6,0	4,9	01016170
M 6	1,0	5,0	80	12	6,0	4,9	01016190
M 7	1,0	6,0	80	12	7,0	5,5	01016200
M 8	1,25	6,8	90	16	8,0	6,2	01016210
M 10	1,5	8,5	100	16	10,0	8,0	01016230

МАШИННЫЙ МЕТЧИК



ТЕХНИЧЕСКАЯ ИНФОРМАЦИЯ

Норма	DIN 376	Вид отверстия	глухое < 3хd
Резьба	M	Направление	правый
Материал	HSSE-G / VAP	Класс точности	6h
Форма	Форма C / RSP 35°	Обр. Материал	VA-Сталь

Машинный метчик с проходным хвостовиком, 2-3 витка резьбы, со спиральной канавкой 35 градусов

М	h	l	l ₁	l ₂	l ₃	α	Арт.-Нр.
M 10	1,5	8,5	100	16	7,0	5,5	02016230
M 12	1,75	10,2	110	18	9,0	7,0	02016250
M 14	2,0	12,0	110	20	11,0	9,0	02016260
M 16	2,0	14,0	110	22	12,0	9,0	02016270
M 18	2,5	15,5	125	25	14,0	11,0	02016280
M 20	2,5	17,5	140	25	16,0	12,0	02016290
M 22	2,5	19,5	140	25	18,0	14,5	02016300
M 24	3,0	21,0	160	30	18,0	14,5	02016310
M 27	3,0	24,0	160	30	20,0	16,0	02016320
M 30	3,5	26,5	180	35	22,0	18,0	02016330
M 33	3,5	29,5	180	35	25,0	20,0	02016340
M 36	4,0	32,0	200	45	28,0	22,0	02016350

МАШИННЫЙ МЕТЧИК



ТЕХНИЧЕСКАЯ ИНФОРМАЦИЯ

Норма	DIN 371	Вид отверстия	глухое < 3хd
Резьба	M	Направление	правый
Материал	HSSE-G / TiN	Класс точности	6h
Форма	Форма C / RSP 35°	Обр. Материал	Сталь

Машинный метчик с проходным хвостовиком, 2-3 витка резьбы, со спиральной канавкой 35 градусов, нитрид титана

М	h	l	l ₁	l ₂	l ₃	α	Арт.-Нр.
M 2	0,4	1,6	45	8	2,8	2,1	01107080
M 2,2	0,45	1,75	45	9	2,8	2,1	01107090
M 2,3	0,4	1,9	45	9	2,8	2,1	01107100
M 2,5	0,45	2,05	50	9	2,8	2,1	01107110
M 2,6	0,45	2,1	50	9	2,8	2,1	01107120
M 3	0,5	2,5	56	7	3,5	2,7	01107130
M 3,5	0,6	2,9	56	7	4,0	3,0	01107140
M 4	0,7	3,3	63	8	4,5	3,4	01107150
M 5	0,8	4,2	70	10	6,0	4,9	01107170
M 6	1,0	5,0	80	12	6,0	4,9	01107190
M 7	1,0	6,0	80	12	7,0	5,5	01107200
M 8	1,25	6,8	90	16	8,0	6,2	01107210
M 10	1,5	8,5	100	16	10,0	8,0	01107230

МАШИННЫЙ МЕТЧИК



ТЕХНИЧЕСКАЯ ИНФОРМАЦИЯ

Норма	DIN 376	Вид отверстия	глухое < 3хd
Резьба	M	Направление	правый
Материал	HSSE-G	Класс точности	6h
Форма	Форма C / RSP 35°	Обр. Материал	Сталь

Машинный метчик с проходным хвостовиком, 2-3 витка резьбы, со спиральной канавкой 35 градусов, нитрид титана

М	1,5	8,5	100	16	7,0	5,5	Арт.-Нр.
M 10	1,5	8,5	100	16	7,0	5,5	02109230
M 12	1,75	10,2	110	18	9,0	7,0	02109250
M 14	2,0	12,0	110	20	11,0	9,0	02109260
M 16	2,0	14,0	110	22	12,0	9,0	02109270
M 18	2,5	15,5	125	25	14,0	11,0	02109280
M 20	2,5	17,5	140	25	16,0	12,0	02109290
M 22	2,5	19,5	140	25	18,0	14,5	02109300
M 24	3,0	21,0	160	30	18,0	14,5	02109310
M 27	3,0	24,0	160	30	20,0	16,0	02109320
M 30	3,5	26,5	180	35	22,0	18,0	02109330
M 33	3,5	29,5	180	35	25,0	20,0	02109340
M 36	4,0	32,0	200	45	28,0	22,0	02109350

МАШИННЫЙ МЕТЧИК



ТЕХНИЧЕСКАЯ ИНФОРМАЦИЯ

Норма	DIN 371	Вид отверстия	глухое < 3хd
Резьба	M	Направление	правый
Материал	HSSE-G	Класс точности	6h
Форма	Форма RSP 45°	Обр. Материал	Алюминий

Машинный метчик с утолщённым хвостовиком, со спиральной канавкой 45 градусов

М	0,4	1,6	45	8	2,8	2,1	Арт.-Нр.
M 2	0,4	1,6	45	8	2,8	2,1	01018080
M 2,2	0,45	1,75	45	9	2,8	2,1	01018090
M 2,3	0,4	1,9	45	9	2,8	2,1	01018100
M 2,5	0,45	2,05	50	9	2,8	2,1	01018110
M 2,6	0,45	2,1	50	9	2,8	2,1	01018120
M 3	0,5	2,5	56	11	3,5	2,7	01018130
M 3,5	0,6	2,9	56	12	4,0	3,0	01018140
M 4	0,7	3,3	63	13	4,5	3,4	01018150
M 5	0,8	4,2	70	16	6,0	4,9	01018170
M 6	1,0	5,0	80	19	6,0	4,9	01018190
M 7	1,0	6,0	80	19	7,0	5,5	01018200
M 8	1,25	6,8	90	22	8,0	6,2	01018210
M 10	1,5	8,5	100	24	10,0	8,0	01018230

МАШИННЫЙ МЕТЧИК



ТЕХНИЧЕСКАЯ ИНФОРМАЦИЯ

Норма	DIN 376	Вид отверстия	глухое < 3хd
Резьба	M	Направление	правый
Материал	HSSE-G	Класс точности	6h
Форма	Форма RSP 45°	Обр. Материал	Алюминий

Машинный метчик с проходным хвостовиком, со спиральной канавкой 45 градусов

М	1,75	10,2	110	28	9,0	7,0	Арт.-Нр.
M 12	1,75	10,2	110	28	9,0	7,0	02018250
M 14	2,0	12,0	110	30	11,0	9,0	02018260
M 16	2,0	14,0	110	32	12,0	9,0	02018270
M 18	2,5	15,5	125	34	14,0	11,0	02018280
M 20	2,5	17,5	140	34	16,0	12,0	02018290
M 22	2,5	19,5	140	34	18,0	14,5	02018300
M 24	3,0	21,0	160	38	18,0	14,5	02018310
M 27	3,0	24,0	160	38	20,0	16,0	02018320
M 30	3,5	26,5	180	45	22,0	18,0	02018330
M 33	3,5	29,5	180	50	25,0	20,0	02018340
M 36	4,0	32,0	200	56	28,0	22,0	02018350



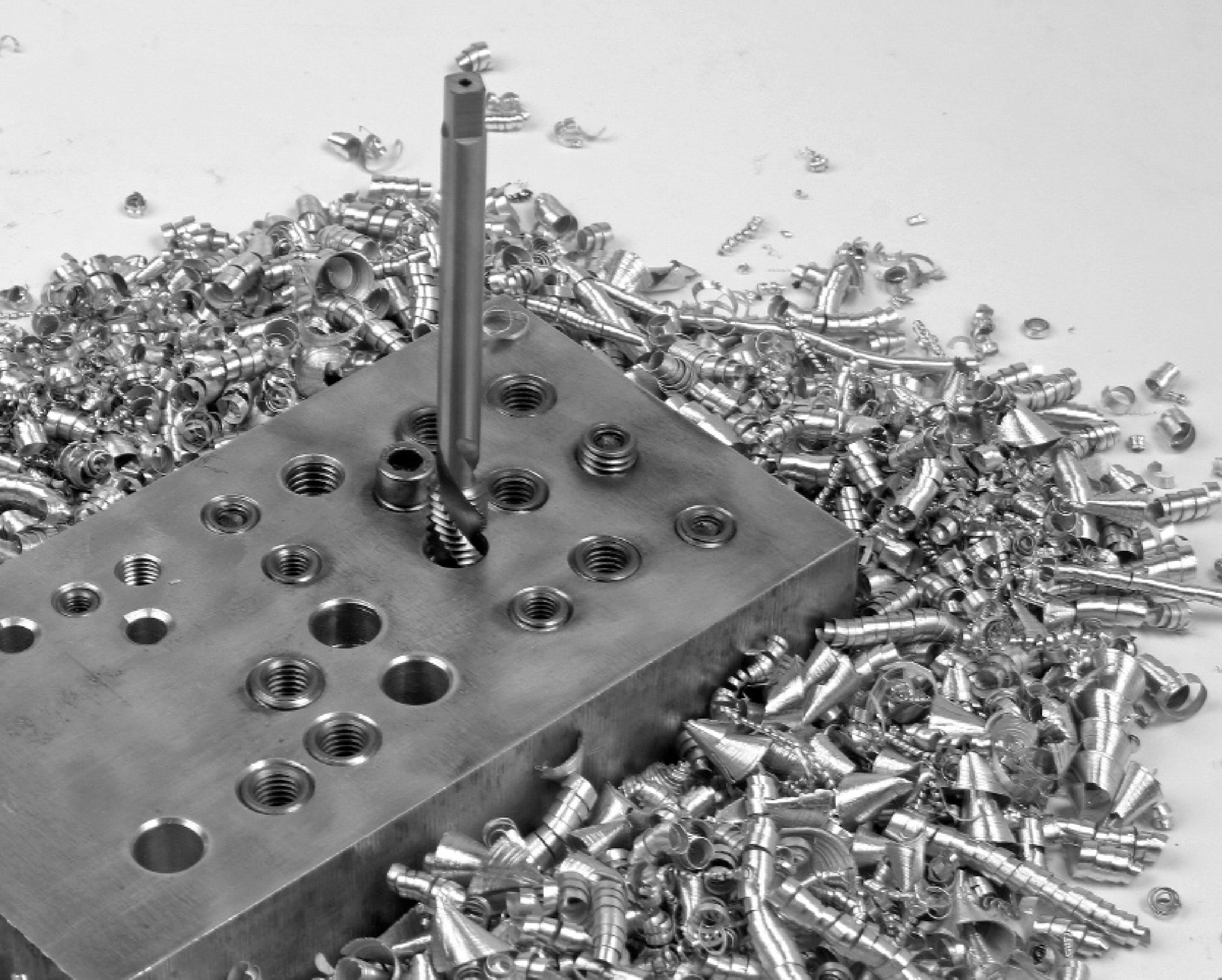

МАШИННЫЙ МЕТЧИК



ТЕХНИЧЕСКАЯ ИНФОРМАЦИЯ

Норма	DIN 374	Вид отверстия	сквозное < 1.1/2xd
Резьба	MF	Направление	правый
Материал	HSS-G	Класс точности	6h
Форма	Форма В	Обр. Материал	Сталь

Машинный метчик с проходным хвостовиком, 4–5 витков резьбы, со спиральной подточкой (стружколом)

							Арт.-Нр.
MF 3 × 0,35	0,35	2,65	56	8	2,2	1,9	00320000
MF 4 × 0,5	0,5	3,5	63	10	2,8	2,1	00320010
MF 5 × 0,5	0,5	4,5	70	12	3,5	2,7	00320020
MF 5 × 0,75	0,75	4,25	70	12	3,5	2,7	00320030
MF 6 × 0,5	0,5	5,5	80	14	4,5	3,4	00320040
MF 6 × 0,75	0,75	5,25	80	14	4,5	3,4	00320050
MF 7 × 0,75	0,75	6,25	80	14	5,5	4,3	00320060
MF 8 × 0,5	0,5	7,5	80	18	6,0	4,9	00320070
MF 8 × 0,75	0,75	7,25	80	18	6,0	4,9	00320080
MF 8 × 1	1,0	7,0	90	22	6,0	4,9	00320090
MF 9 × 1	1,0	8,0	90	22	7,0	5,5	00320100
MF 10 × 0,5	0,5	9,5	90	20	7,0	5,5	00320110
MF 10 × 0,75	0,75	9,25	90	20	7,0	5,5	00320120
MF 10 × 1	1,0	9,0	90	20	7,0	5,5	00320130
MF 10 × 1,25	1,25	8,75	100	20	7,0	5,5	00320140
MF 11 × 0,75	0,75	10,25	90	20	8,0	6,2	00320150
MF 11 × 1	1,0	10,0	90	20	8,0	6,2	00320160
MF 11 × 1,25	1,25	9,75	90	20	8,0	6,2	00320170
MF 12 × 0,5	0,5	11,5	100	22	9,0	7,0	00320180
MF 12 × 0,75	0,75	11,25	100	22	9,0	7,0	00320190
MF 12 × 1	1,0	11,0	100	22	9,0	7,0	00320200
MF 12 × 1,25	1,25	10,75	100	22	9,0	7,0	00320210
MF 12 × 1,5	1,5	10,5	100	22	9,0	7,0	00320220
MF 13 × 0,5	0,5	12,5	100	22	11,0	9,0	00320230
MF 13 × 0,75	0,75	12,25	100	22	11,0	9,0	00320240
MF 13 × 1	1,0	12,0	100	22	11,0	9,0	00320250
MF 13 × 1,25	1,25	11,75	100	22	11,0	9,0	00320260
MF 13 × 1,5	1,5	11,5	100	22	11,0	9,0	00320270
MF 14 × 0,5	0,5	13,5	100	22	11,0	9,0	00320280
MF 14 × 0,75	0,75	13,25	100	22	11,0	9,0	00320290
MF 14 × 1	1,0	13,0	100	22	11,0	9,0	00320300
MF 14 × 1,25	1,25	12,75	100	22	11,0	9,0	00320310
MF 14 × 1,5	1,5	12,5	100	22	11,0	9,0	00320320
MF 15 × 0,5	0,5	14,5	100	22	12,0	9,0	00320330
MF 15 × 0,75	0,75	14,25	100	22	12,0	9,0	00320340
MF 15 × 1	1,0	14,0	100	22	12,0	9,0	00320350

							Арт.-Нр.
MF 15 × 1,25	1,25	13,8	100	22	12,0	9,0	00320360
MF 15 × 1,5	1,5	13,5	100	22	12,0	9,0	00320370
MF 16 × 0,5	0,5	15,5	100	22	12,0	9,0	00320380
MF 16 × 0,75	0,75	15,25	100	22	12,0	9,0	00320390
MF 16 × 1	1,0	15,0	100	22	12,0	9,0	00320400
MF 16 × 1,25	1,25	14,75	100	22	12,0	9,0	00320410
MF 16 × 1,5	1,5	14,5	100	22	12,0	9,0	00320420
MF 17 × 0,75	0,75	16,25	100	22	12,0	9,0	00320430
MF 17 × 1	1,0	16,0	100	22	12,0	9,0	00320440
MF 17 × 1,5	1,5	15,5	100	22	12,0	9,0	00320450
MF 18 × 0,75	0,75	17,25	110	25	14,0	11,0	00320460
MF 18 × 1	1,0	17,0	110	25	14,0	11,0	00320470
MF 18 × 1,25	1,25	16,75	110	25	14,0	11,0	00320480
MF 18 × 1,5	1,5	16,5	110	25	14,0	11,0	00320490
MF 18 × 2	2,0	16,0	125	34	14,0	11,0	00320500
MF 20 × 0,75	0,75	19,25	125	25	16,0	12,0	00320510
MF 20 × 1	1,0	19,0	125	25	16,0	12,0	00320520
MF 20 × 1,25	1,25	18,75	125	25	16,0	12,0	00320530
MF 20 × 1,5	1,5	18,5	125	25	16,0	12,0	00320540
MF 20 × 2	2,0	18,0	140	34	16,0	12,0	00320550
MF 21 × 1	1,0	20,0	125	25	16,0	12,0	00320560
MF 21 × 1,5	1,5	19,5	125	25	16,0	12,0	00320570
MF 22 × 0,75	0,75	21,25	125	25	18,0	14,5	00320580
MF 22 × 1	1,0	21,0	125	25	18,0	14,5	00320590
MF 22 × 1,25	1,25	20,75	125	25	18,0	14,5	00320600
MF 22 × 1,5	1,5	20,5	125	25	18,0	14,5	00320610
MF 22 × 2	2,0	20,0	140	34	18,0	14,5	00320620
MF 23 × 1	1,0	22,0	125	28	18,0	14,5	00320630
MF 23 × 1,5	1,5	21,5	125	28	18,0	14,5	00320640
MF 24 × 0,75	0,75	23,25	140	28	18,0	14,5	00320650
MF 24 × 1	1,0	23,0	140	28	18,0	14,5	00320660
MF 24 × 1,25	1,25	22,75	140	28	18,0	14,5	00320670
MF 24 × 1,5	1,5	22,5	140	28	18,0	14,5	00320680
MF 24 × 2	2,0	22,0	140	28	18,0	14,5	00320690
MF 25 × 1	1,0	24,0	140	28	18,0	14,5	00320700
MF 25 × 1,5	1,5	23,5	140	28	18,0	14,5	00320710
MF 25 × 2	2,0	23,0	140	28	18,0	14,5	00320720
MF 26 × 1	1,0	25,0	140	28	18,0	14,5	00320730
MF 26 × 1,5	1,5	24,5	140	28	18,0	14,5	00320740
MF 26 × 2	2,0	24,0	140	28	18,0	14,5	00320750
MF 27 × 1	1,0	26,0	150	28	20,0	16,0	00320760
MF 27 × 1,5	1,5	25,5	140	28	20,0	16,0	00320770
MF 27 × 2	2,0	25,0	140	28	20,0	16,0	00320780
MF 28 × 1	1,0	27,0	140	28	20,0	16,0	00320790

							Арт.-Нр.
MF 28 × 1,5	1,5	26,5	140	28	20,0	16,0	00320800
MF 28 × 2	2,0	26,0	140	28	20,0	16,0	00320810
MF 30 × 1	1,0	29,0	150	28	22,0	18,0	00320820
MF 30 × 1,5	1,5	28,5	150	28	22,0	18,0	00320830
MF 30 × 2	2,0	28,0	150	28	22,0	18,0	00320840
MF 30 × 3	3,0	27,0	180	45	22,0	18,0	00320850
MF 32 × 1	1,0	31,0	150	30	22,0	18,0	00320860
MF 32 × 1,5	1,5	30,5	150	30	22,0	18,0	00320870
MF 32 × 2	2,0	30,0	150	30	22,0	18,0	00320880
MF 32 × 3	3,0	29,0	180	50	22,0	18,0	00320890
MF 33 × 1	1,0	32,0	150	30	25,0	20,0	00320900
MF 33 × 1,5	1,5	31,5	160	30	25,0	20,0	00320910
MF 33 × 2	2,0	31,0	160	30	25,0	20,0	00320920
MF 33 × 3	3,0	30,0	180	50	25,0	20,0	00320930
MF 34 × 1	1,0	33,0	170	30	28,0	22,0	00320940
MF 34 × 1,5	1,5	32,5	170	30	28,0	22,0	00320950
MF 34 × 2	2,0	32,0	170	30	28,0	22,0	00320960
MF 34 × 3	3,0	31,0	200	56	28,0	22,0	00320970
MF 35 × 1	1,0	34,0	170	30	28,0	22,0	00320980
MF 35 × 1,5	1,5	33,5	170	30	28,0	22,0	00320990
MF 35 × 2	2,0	33,0	170	30	28,0	22,0	00321000
MF 35 × 3	3,0	32,0	200	56	28,0	22,0	00321010
MF 36 × 1	1,0	35,0	170	30	28,0	22,0	00321020
MF 36 × 1,5	1,5	34,5	170	30	28,0	22,0	00321030
MF 36 × 2	2,0	34,0	170	30	28,0	22,0	00321040
MF 36 × 3	3,0	33,0	200	56	28,0	22,0	00321050
MF 38 × 1	1,0	37,0	170	30	28,0	22,0	00321060
MF 38 × 1,5	1,5	36,5	170	30	28,0	22,0	00321070
MF 38 × 2	2,0	36,0	170	30	28,0	22,0	00321080
MF 38 × 3	3,0	35,0	200	56	28,0	22,0	00321090
MF 39 × 1,5	1,5	37,5	170	30	32,0	24,0	00321100
MF 39 × 2	2,0	37,0	170	30	32,0	24,0	00321110
MF 39 × 3	3,0	36,0	200	60	32,0	24,0	00321120
MF 40 × 1,5	1,5	38,5	170	30	32,0	24,0	00321130
MF 40 × 2	2,0	38,0	170	30	32,0	24,0	00321140
MF 40 × 3	3,0	37,0	200	60	32,0	24,0	00321150
MF 42 × 1,5	1,5	40,5	170	30	32,0	24,0	00321160
MF 42 × 2	2,0	40,0	170	30	32,0	24,0	00321170
MF 42 × 3	3,0	39,0	200	60	32,0	24,0	00321180
MF 42 × 4	4,0	38,0	225	60	32,0	24,0	00321190
MF 45 × 1,5	1,5	43,5	180	32	36,0	29,0	00321200
MF 45 × 2	2,0	43,0	180	32	36,0	29,0	00321210
MF 45 × 3	3,0	42,0	200	50	36,0	29,0	00321220
MF 45 × 4	4,0	41,0	225	65	36,0	29,0	00321230

							Арт.-Нр.
MF 48 × 1,5	1,5	46,5	190	32	36,0	29,0	00321240
MF 48 × 2	2,0	46,0	190	32	36,0	29,0	00321250
MF 48 × 3	3,0	45,0	225	50	36,0	29,0	00321260
MF 48 × 4	4,0	44,0	225	70	36,0	29,0	00321270
MF 50 × 1,5	1,5	48,5	190	32	36,0	29,0	00321280
MF 50 × 2	2,0	48,0	190	32	36,0	29,0	00321290
MF 50 × 3	3,0	47,0	225	50	36,0	29,0	00321300
MF 50 × 4	4,0	46,0	225	70	36,0	29,0	00321310
MF 52 × 1,5	1,5	50,5	190	32	40,0	32,0	00321320
MF 52 × 2	2,0	50,0	190	32	40,0	32,0	00321330
MF 52 × 3	3,0	49,0	225	50	40,0	32,0	00321340
MF 52 × 4	4,0	48,0	225	70	40,0	29,0	00321350

МАШИННЫЙ МЕТЧИК



Машинный метчик с проходным хвостовиком, 2-3 витка резьбы, с прямой канавкой

ТЕХНИЧЕСКАЯ ИНФОРМАЦИЯ

Норма	DIN 374	Вид отверстия	глухое < 1.1/2xd
Резьба	MF	Направление	правый
Материал	HSS-G	Класс точности	6h
Форма	Форма С	Обр. Материал	Сталь

							Арт.-Нр.
MF 3 × 0,35	0,35	2,65	56	8	2,2	1,9	00315230
MF 4 × 0,5	0,5	3,5	63	10	2,8	2,1	00315240
MF 5 × 0,5	0,5	4,5	70	12	3,5	2,7	00315280
MF 5 × 0,75	0,75	4,25	70	12	3,5	2,7	00315290
MF 6 × 0,5	0,5	5,5	80	14	4,5	3,4	00315310
MF 6 × 0,75	0,75	5,25	80	14	4,5	3,4	00315330
MF 7 × 0,75	0,75	6,25	80	14	5,5	4,3	00315350
MF 8 × 0,5	0,5	7,5	80	18	6,0	4,9	00315370
MF 8 × 0,75	0,75	7,25	80	18	6,0	4,9	00315390
MF 8 × 1	1,0	7,0	90	22	6,0	4,9	00315400
MF 9 × 1	1,0	8,0	90	22	7,0	5,5	00315410
MF 10 × 0,5	0,5	9,5	90	20	7,0	5,5	00315420
MF 10 × 0,75	0,75	9,25	90	20	7,0	5,5	00315430
MF 10 × 1	1,0	9,0	90	20	7,0	5,5	00315470
MF 10 × 1,25	1,25	8,75	100	20	7,0	5,5	00315480
MF 11 × 0,75	0,75	10,25	90	20	8,0	6,2	00315490
MF 11 × 1	1,0	10,0	90	20	8,0	6,2	00315500
MF 11 × 1,25	1,25	9,75	90	20	8,0	6,2	00315510
MF 12 × 0,5	0,5	11,5	100	22	9,0	7,0	00315520
MF 12 × 0,75	0,75	11,25	100	22	9,0	7,0	00315530

							Арт.-Нр.
MF 12 × 1	1,0	11,0	100	22	9,0	7,0	00315550
MF 12 × 1,25	1,25	10,75	100	22	9,0	7,0	00315560
MF 12 × 1,5	1,5	10,5	100	22	9,0	7,0	00315570
MF 13 × 0,5	0,5	12,5	100	22	11,0	9,0	00315580
MF 13 × 0,75	0,75	12,25	100	22	11,0	9,0	00315590
MF 13 × 1	1,0	12,0	100	22	11,0	9,0	00315600
MF 13 × 1,25	1,25	11,75	100	22	11,0	9,0	00315610
MF 13 × 1,5	1,5	11,5	100	22	11,0	9,0	00315620
MF 14 × 0,5	0,5	13,5	100	22	11,0	9,0	00315630
MF 14 × 0,75	0,75	13,25	100	22	11,0	9,0	00315640
MF 14 × 1	1,0	13,0	100	22	11,0	9,0	00315650
MF 14 × 1,25	1,25	12,75	100	22	11,0	9,0	00315660
MF 14 × 1,5	1,5	12,5	100	22	11,0	9,0	00315670
MF 15 × 0,75	0,75	14,25	100	22	12,0	9,0	00315680
MF 15 × 1	1,0	14,0	100	22	12,0	9,0	00315690
MF 15 × 1,25	1,25	13,8	100	22	12,0	9,0	00315700
MF 15 × 1,5	1,5	13,5	100	22	12,0	9,0	00315710
MF 16 × 0,5	0,5	15,5	100	22	12,0	9,0	00315720
MF 16 × 0,75	0,75	15,25	100	22	12,0	9,0	00315730
MF 16 × 1	1,0	15,0	100	22	12,0	9,0	00315750
MF 16 × 1,25	1,25	14,75	100	22	12,0	9,0	00315760
MF 16 × 1,5	1,5	14,5	100	22	12,0	9,0	00315770
MF 17 × 0,75	0,75	16,25	100	22	12,0	9,0	00315780
MF 17 × 1	1,0	16,0	100	22	12,0	9,0	00315790
MF 17 × 1,5	1,5	15,5	100	22	12,0	9,0	00315800
MF 18 × 0,75	0,75	17,25	110	25	14,0	11,0	00315810
MF 18 × 1	1,0	17,0	110	25	14,0	11,0	00315840
MF 18 × 1,25	1,25	16,75	110	25	14,0	11,0	00315850
MF 18 × 1,5	1,5	16,5	110	25	14,0	11,0	00315860
MF 18 × 2	2,0	16,0	125	34	14,0	11,0	00315870
MF 20 × 0,75	0,75	19,25	125	25	16,0	12,0	00315880
MF 20 × 1	1,0	19,0	125	25	16,0	12,0	00315930
MF 20 × 1,25	1,25	18,75	125	25	16,0	12,0	00315940
MF 20 × 1,5	1,5	18,5	125	25	16,0	12,0	00315950
MF 20 × 2	2,0	18,0	140	34	16,0	12,0	00315960
MF 21 × 1	1,0	20,0	125	25	16,0	12,0	00315970
MF 21 × 1,5	1,5	19,5	125	25	16,0	12,0	00315980
MF 22 × 0,75	0,75	21,25	125	25	18,0	14,5	00315990
MF 22 × 1	1,0	21,0	125	25	18,0	14,5	00316000
MF 22 × 1,25	1,25	20,75	125	25	18,0	14,5	00316010
MF 22 × 1,5	1,5	20,5	125	25	18,0	14,5	00316050
MF 22 × 2	2,0	20,0	140	34	18,0	14,5	00316060
MF 23 × 1	1,0	22,0	125	28	18,0	14,5	00316070
MF 23 × 1,5	1,5	21,5	125	28	18,0	14,5	00316080

							Арт.-Нр.
MF 24 × 0,75	0,75	23,25	140	28	18,0	14,5	00316090
MF 24 × 1	1,0	23,0	140	28	18,0	14,5	00316110
MF 24 × 1,25	1,25	22,75	140	28	18,0	14,5	00316120
MF 24 × 1,5	1,5	22,5	140	28	18,0	14,5	00316130
MF 24 × 2	2,0	22,0	140	28	18,0	14,5	00316140
MF 25 × 1	1,0	24,0	140	28	18,0	14,5	00316150
MF 25 × 1,5	1,5	23,5	140	28	18,0	14,5	00316160
MF 25 × 2	2,0	23,0	140	28	18,0	14,5	00316170
MF 26 × 1	1,0	25,0	140	28	18,0	14,5	00316190
MF 26 × 1,5	1,5	24,5	140	28	18,0	14,5	00316210
MF 26 × 2	2,0	24,0	140	28	18,0	14,5	00316220
MF 27 × 1	1,0	26,0	150	28	20,0	16,0	00316230
MF 27 × 1,5	1,5	25,5	140	28	20,0	16,0	00316240
MF 27 × 2	2,0	25,0	140	28	20,0	16,0	00316250
MF 28 × 1	1,0	27,0	140	28	20,0	16,0	00316260
MF 28 × 1,5	1,5	26,5	140	28	20,0	16,0	00316270
MF 28 × 2	2,0	26,0	140	28	20,0	16,0	00316280
MF 30 × 1	1,0	29,0	150	28	22,0	18,0	00316290
MF 30 × 1,5	1,5	28,5	150	28	22,0	18,0	00316300
MF 30 × 2	2,0	28,0	150	28	22,0	18,0	00316310
MF 30 × 3	3,0	27,0	180	45	22,0	18,0	00312320
MF 32 × 1	1,0	31,0	150	30	22,0	18,0	00312330
MF 32 × 1,5	1,5	30,5	150	30	22,0	18,0	00312340
MF 32 × 2	2,0	30,0	150	30	22,0	18,0	00312350
MF 32 × 3	3,0	29,0	180	50	22,0	18,0	00312360
MF 33 × 1	1,0	32,0	150	30	25,0	20,0	00312370
MF 33 × 1,5	1,5	31,5	160	30	25,0	20,0	00312380
MF 33 × 2	2,0	31,0	160	30	25,0	20,0	00312390
MF 33 × 3	3,0	30,0	180	50	25,0	20,0	00312400
MF 34 × 1	1,0	33,0	170	30	28,0	22,0	00312410
MF 34 × 1,5	1,5	32,5	170	30	28,0	22,0	00312420
MF 34 × 2	2,0	32,0	170	30	28,0	22,0	00312430
MF 34 × 3	3,0	31,0	200	56	28,0	22,0	00312440
MF 35 × 1	1,0	34,0	170	30	28,0	22,0	00312450
MF 35 × 1,5	1,5	33,5	170	30	28,0	22,0	00312460
MF 35 × 2	2,0	33,0	170	30	28,0	22,0	00312470
MF 35 × 3	3,0	32,0	200	56	28,0	22,0	00312480
MF 36 × 1	1,0	35,0	170	30	28,0	22,0	00312490
MF 36 × 1,5	1,5	34,5	170	30	28,0	22,0	00312500
MF 36 × 2	2,0	34,0	170	30	28,0	22,0	00312510
MF 36 × 3	3,0	33,0	200	56	28,0	22,0	00312520
MF 38 × 1	1,0	37,0	170	30	28,0	22,0	00312530
MF 38 × 1,5	1,5	36,5	170	30	28,0	22,0	00312540
MF 38 × 2	2,0	36,0	170	30	28,0	22,0	00312550

							Арт.-Нр.
MF 38 × 3	3,0	35,0	200	56	28,0	22,0	00312560
MF 39 × 1,5	1,5	37,5	170	30	32,0	24,0	00312570
MF 39 × 2	2,0	37,0	170	30	32,0	24,0	00312580
MF 39 × 3	3,0	36,0	200	60	32,0	24,0	00312590
MF 40 × 1,5	1,5	38,5	170	30	32,0	24,0	00312610
MF 40 × 2	2,0	38,0	170	30	32,0	24,0	00312620
MF 40 × 3	3,0	37,0	200	60	32,0	24,0	00312630
MF 42 × 1,5	1,5	40,5	170	30	32,0	24,0	00312640
MF 42 × 2	2,0	40,0	170	30	32,0	24,0	00312650
MF 42 × 3	3,0	39,0	200	60	32,0	24,0	00312660
MF 42 × 4	4,0	38,0	225	60	32,0	24,0	00312670
MF 45 × 1,5	1,5	43,5	180	32	36,0	29,0	00312690
MF 45 × 2	2,0	43,0	180	32	36,0	29,0	00312700
MF 45 × 3	3,0	42,0	200	50	36,0	29,0	00312710
MF 45 × 4	4,0	41,0	225	65	36,0	29,0	00312720
MF 48 × 1,5	1,5	46,5	190	32	36,0	29,0	00312740
MF 48 × 2	2,0	46,0	190	32	36,0	29,0	00312750
MF 48 × 3	3,0	45,0	225	50	36,0	29,0	00312760
MF 48 × 4	4,0	44,0	225	70	36,0	29,0	00312770
MF 50 × 1,5	1,5	48,5	190	32	36,0	29,0	00312780
MF 50 × 2	2,0	48,0	190	32	36,0	29,0	00312800
MF 50 × 3	3,0	47,0	225	50	36,0	29,0	00312810
MF 50 × 4	4,0	46,0	225	70	36,0	29,0	00312820
MF 52 × 1,5	1,5	50,5	190	32	40,0	32,0	00312840
MF 52 × 2	2,0	50,0	190	32	40,0	32,0	00312850
MF 52 × 3	3,0	49,0	225	50	40,0	32,0	00312860
MF 52 × 4	4,0	48,0	225	70	40,0	29,0	00312870

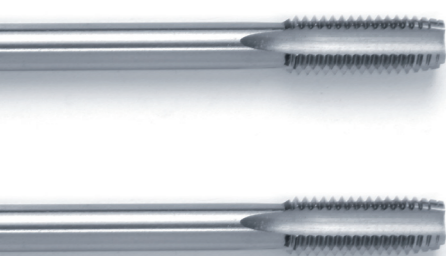

МАШИННЫЙ МЕТЧИК



Машинный метчик с проходным хвостовиком, со спиральной канавкой 15 градусов, 2-3 витка резьбы

ТЕХНИЧЕСКАЯ ИНФОРМАЦИЯ

Норма	DIN 374	Вид отверстия	глухое < 2хd
Резьба	MF	Направление	правый
Материал	HSS-G	Класс точности	6h
Форма	Форма С / RSP 15°	Обр. Материал	Сталь

							Арт.-Нр.
MF 5 × 0,5	0,5	4,5	70	8	3,5	2,7	00318280
MF 6 × 0,75	0,75	5,25	80	12	4,5	3,4	00318330
MF 8 × 0,75	0,75	7,25	80	12	6,0	4,9	00318390
MF 8 × 1	1,0	7,0	90	16	6,0	4,9	00318400
MF 10 × 1	1,0	9,0	90	16	7,0	5,5	00318470
MF 10 × 1,25	1,25	8,7	100	16	7,0	5,5	00318480
MF 12 × 1	1,0	11,0	100	16	9,0	7,0	00318550
MF 12 × 1,25	1,25	10,7	100	16	9,0	7,0	00318560
MF 12 × 1,5	1,5	10,5	100	16	9,0	7,0	00318570
MF 13 × 1,5	1,5	11,5	100	16	11,0	9,0	00318620
MF 14 × 1	1,0	13,0	100	16	11,0	9,0	00318650
MF 14 × 1,25	1,25	12,75	100	16	11,0	9,0	00318660
MF 14 × 1,5	1,5	12,5	100	16	11,0	9,0	00318670
MF 15 × 1,5	1,5	13,5	100	16	12,0	9,0	00318710
MF 15 × 1,5	1,5	13,5	100	16	12,0	9,0	00318720
MF 16 × 1	1,0	15,0	100	16	12,0	9,0	00318750
MF 16 × 1,25	1,25	14,75	100	16	12,0	9,0	00318760
MF 16 × 1,5	1,5	14,5	100	16	12,0	9,0	00318770
MF 18 × 1	1,0	17,0	110	20	14,0	11,0	00318840
MF 18 × 1,5	1,5	16,5	110	20	14,0	11,0	00318860
MF 20 × 1	1,0	19,0	125	20	16,0	12,0	00318930
MF 20 × 1,5	1,5	18,5	125	20	16,0	12,0	00318950
MF 20 × 2	2,0	18,0	140	25	16,0	12,0	00318960
MF 22 × 1	1,0	21,0	125	20	18,0	14,5	00319030
MF 22 × 1,5	1,5	20,5	125	20	18,0	14,5	00319050
MF 22 × 2	2,0	20,0	140	25	18,0	14,5	00319060
MF 24 × 1	1,0	23,0	125	20	18,0	14,5	00319110
MF 24 × 1,5	1,5	22,5	140	20	18,0	14,5	00319130
MF 24 × 2	2,0	22,0	140	20	18,0	14,5	00319140
MF 26 × 1	1,0	25,0	140	20	18,0	14,5	00319190
MF 26 × 1,5	1,5	24,5	140	20	18,0	14,5	00319210
MF 26 × 2	2,0	24,0	140	20	18,0	14,5	00319220
MF 27 × 1	1,0	26,0	150	20	20,0	16,0	00319230
MF 27 × 1,5	1,5	25,5	140	20	20,0	16,0	00319240
MF 27 × 2	2,0	25,0	140	20	20,0	16,0	00319250
MF 28 × 1	1,0	27,0	150	20	20,0	16,0	00319260

							Арт.-Нр.
MF 28 × 1,5	1,5	26,5	140	20	20,0	16,0	00319270
MF 28 × 2	2,0	26,0	140	20	20,0	16,0	00319280
MF 30 × 1	1,0	29,0	150	22	22,0	18,0	00319290
MF 30 × 1,5	1,5	28,5	150	22	22,0	18,0	00319300
MF 30 × 2	2,0	28,0	150	22	22,0	18,0	00319310
MF 30 × 3	3,0	27,0	180	35	22,0	18,0	00319320
MF 32 × 1,5	1,5	30,5	150	22	22,0	18,0	00319340
MF 32 × 2	2,0	30,0	150	22	22,0	18,0	00319350
MF 33 × 1,5	1,5	31,5	160	25	25,0	20,0	00319380
MF 33 × 2	2,0	31,0	160	25	25,0	20,0	00319390
MF 35 × 1,5	1,5	33,5	170	25	28,0	22,0	00319460
MF 36 × 1,5	1,5	34,5	170	25	28,0	22,0	00319500
MF 36 × 2	2,0	34,0	170	25	28,0	22,0	00319510
MF 38 × 1,5	1,5	36,5	170	25	28,0	22,0	00319540
MF 39 × 1,5	1,5	37,5	170	25	32,0	24,0	00319570
MF 40 × 1,5	1,5	38,5	170	25	32,0	24,0	00319610
MF 42 × 1,5	1,5	40,5	170	25	32,0	24,0	00319640
MF 45 × 1,5	1,5	43,5	180	27	36,0	29,0	00319690
MF 48 × 1,5	1,5	46,5	190	27	36,0	29,0	00319740
MF 50 × 1,5	1,5	48,5	190	27	36,0	29,0	00319790

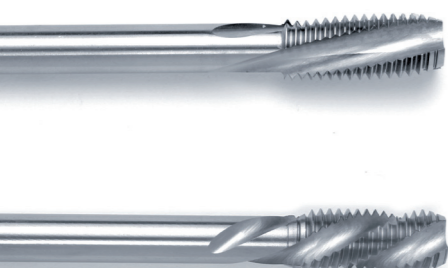

МАШИННЫЙ МЕТЧИК

















Машинный метчик с проходным хвостовиком, со спиральной канавкой 35 градусов, 2-3 витка резьбы

ТЕХНИЧЕСКАЯ ИНФОРМАЦИЯ

Норма	DIN 374	Вид отверстия	глухое < 3хd
Резьба	MF	Направление	правый
Материал	HSS-G	Класс точности	6h
Форма	Форма С / RSP 35°	Обр. Материал	Сталь

							Арт.-Нр.
MF 3 × 0,35	0,35	2,65	56	8	2,2	1,9	00323000
MF 4 × 0,5	0,5	3,5	63	8	2,8	2,1	00323010
MF 5 × 0,5	0,5	4,5	70	8	3,5	2,7	00323020
MF 5 × 0,75	0,75	4,25	70	8	3,5	2,7	00323030
MF 6 × 0,5	0,5	5,5	80	12	4,5	3,4	00323040
MF 6 × 0,75	0,75	5,25	80	12	4,5	3,4	00323050
MF 7 × 0,75	0,75	6,25	80	12	5,5	4,3	00323060
MF 8 × 0,5	0,5	7,5	80	12	6,0	4,9	00323070
MF 8 × 0,75	0,75	7,25	80	12	6,0	4,9	00323080
MF 8 × 1	1,0	7,0	90	16	6,0	4,9	00323090
MF 9 × 1	1,0	8,0	90	16	7,0	5,5	00323100
MF 10 × 0,5	0,5	9,5	90	16	7,0	5,5	00323110
MF 10 × 0,75	0,75	9,25	90	16	7,0	5,5	00323120
MF 10 × 1	1,0	9,0	90	16	7,0	5,5	00323130
MF 10 × 1,25	1,25	8,75	100	16	7,0	5,5	00323140
MF 11 × 0,75	0,75	10,25	90	16	8,0	6,2	00323150
MF 11 × 1	1,0	10,0	90	16	8,0	6,2	00323160
MF 11 × 1,25	1,25	9,75	90	16	8,0	6,2	00323170
MF 12 × 0,5	0,5	11,5	100	16	9,0	7,0	00323180
MF 12 × 0,75	0,75	11,25	100	16	9,0	7,0	00323190
MF 12 × 1	1,0	11,0	100	16	9,0	7,0	00323200
MF 12 × 1,25	1,25	10,75	100	16	9,0	7,0	00323210
MF 12 × 1,5	1,5	10,5	100	16	9,0	7,0	00323220
MF 13 × 0,5	0,5	12,5	100	16	11,0	9,0	00323230
MF 13 × 0,75	0,75	12,25	100	16	11,0	9,0	00323240
MF 13 × 1	1,0	12,0	100	16	11,0	9,0	00323250
MF 13 × 1,25	1,25	11,75	100	16	11,0	9,0	00323260
MF 13 × 1,5	1,5	11,5	100	16	11,0	9,0	00323270
MF 14 × 0,5	0,5	13,5	100	16	11,0	9,0	00323280
MF 14 × 0,75	0,75	13,25	100	16	11,0	9,0	00323290
MF 14 × 1	1,0	13,0	100	16	11,0	9,0	00323300
MF 14 × 1,25	1,25	12,75	100	16	11,0	9,0	00323310
MF 14 × 1,5	1,5	12,5	100	16	11,0	9,0	00323320
MF 15 × 0,5	0,5	14,5	100	16	12,0	9,0	00323330
MF 15 × 0,75	0,75	14,25	100	16	12,0	9,0	00323340
MF 15 × 1	1,0	14,0	100	16	12,0	9,0	00323350

							Арт.-Нр.
MF 15 × 1,25	1,25	13,8	100	16	12,0	9,0	00323360
MF 15 × 1,5	1,5	13,5	100	16	12,0	9,0	00323370
MF 16 × 0,5	0,5	15,5	100	16	12,0	9,0	00323380
MF 16 × 0,75	0,75	15,25	100	16	12,0	9,0	00323390
MF 16 × 1	1,0	15,0	100	16	12,0	9,0	00323400
MF 16 × 1,25	1,25	14,75	100	16	12,0	9,0	00323410
MF 16 × 1,5	1,5	14,5	100	16	12,0	9,0	00323420
MF 17 × 0,75	0,75	16,25	100	16	12,0	9,0	00323430
MF 17 × 1	1,0	16,0	100	16	12,0	9,0	00323440
MF 17 × 1,5	1,5	15,5	100	16	12,0	9,0	00323450
MF 18 × 0,75	0,75	17,25	110	20	14,0	11,0	00323460
MF 18 × 1	1,0	17,0	110	20	14,0	11,0	00323470
MF 18 × 1,25	1,25	16,75	110	20	14,0	11,0	00323480
MF 18 × 1,5	1,5	16,5	110	20	14,0	11,0	00323490
MF 18 × 2	2,0	16,0	125	25	14,0	11,0	00323500
MF 20 × 0,75	0,75	19,25	125	20	16,0	12,0	00323510
MF 20 × 1	1,0	19,0	125	20	16,0	12,0	00323520
MF 20 × 1,25	1,25	18,75	125	20	16,0	12,0	00323530
MF 20 × 1,5	1,5	18,5	125	20	16,0	12,0	00323540
MF 20 × 2	2,0	18,0	140	25	16,0	12,0	00323550
MF 21 × 1	1,0	20,0	125	20	16,0	12,0	00323560
MF 21 × 1,5	1,5	19,5	125	20	16,0	12,0	00323570
MF 22 × 0,75	0,75	21,25	125	20	18,0	14,5	00323580
MF 22 × 1	1,0	21,0	125	20	18,0	14,5	00323590
MF 22 × 1,25	1,25	20,75	125	20	18,0	14,5	00323600
MF 22 × 1,5	1,5	20,5	125	20	18,0	14,5	00323610
MF 22 × 2	2,0	20,0	140	25	18,0	14,5	00323620
MF 23 × 1	1,0	22,0	125	20	18,0	14,5	00323630
MF 23 × 1,5	1,5	21,5	125	20	18,0	14,5	00323640
MF 24 × 0,75	0,75	23,25	140	20	18,0	14,5	00323650
MF 24 × 1	1,0	23,0	140	20	18,0	14,5	00323660
MF 24 × 1,25	1,25	22,75	140	20	18,0	14,5	00323670
MF 24 × 1,5	1,5	22,5	140	20	18,0	14,5	00323680
MF 24 × 2	2,0	22,0	140	20	18,0	14,5	00323690
MF 25 × 1	1,0	24,0	140	20	18,0	14,5	00323700
MF 25 × 1,5	1,5	23,5	140	20	18,0	14,5	00323710
MF 25 × 2	2,0	23,0	140	20	18,0	14,5	00323720
MF 26 × 1	1,0	25,0	140	20	18,0	14,5	00323730
MF 26 × 1,5	1,5	24,5	140	20	18,0	14,5	00323740
MF 26 × 2	2,0	24,0	140	20	18,0	14,5	00323750
MF 27 × 1	1,0	26,0	150	20	20,0	16,0	00323760
MF 27 × 1,5	1,5	25,5	140	20	20,0	16,0	00323770
MF 27 × 2	2,0	25,0	140	20	20,0	16,0	00323780
MF 28 × 1	1,0	27,0	140	20	20,0	16,0	00323790

							Арт.-Нр.
MF 28 × 1,5	1,5	26,5	140	20	20,0	16,0	00323800
MF 28 × 2	2,0	26,0	140	20	20,0	16,0	00323810
MF 30 × 1	1,0	29,0	150	22	22,0	18,0	00323820
MF 30 × 1,5	1,5	28,5	150	22	22,0	18,0	00323830
MF 30 × 2	2,0	28,0	150	22	22,0	18,0	00323840
MF 30 × 3	3,0	27,0	180	35	22,0	18,0	00323850
MF 32 × 1	1,0	31,0	150	22	22,0	18,0	00323860
MF 32 × 1,5	1,5	30,5	150	22	22,0	18,0	00323870
MF 32 × 2	2,0	30,0	150	22	22,0	18,0	00323880
MF 32 × 3	3,0	29,0	180	35	22,0	18,0	00323890
MF 33 × 1	1,0	32,0	150	25	25,0	20,0	00323900
MF 33 × 1,5	1,5	31,5	160	25	25,0	20,0	00323910
MF 33 × 2	2,0	31,0	160	25	25,0	20,0	00323920
MF 33 × 3	3,0	30,0	180	35	25,0	20,0	00323930
MF 34 × 1	1,0	33,0	170	25	28,0	22,0	00323940
MF 34 × 1,5	1,5	32,5	170	28	28,0	22,0	00323950
MF 34 × 2	2,0	32,0	170	32	28,0	22,0	00323960
MF 34 × 3	3,0	31,0	200	36	28,0	22,0	00323970
MF 35 × 1	1,0	34,0	170	25	28,0	22,0	00323980
MF 35 × 1,5	1,5	33,5	170	25	28,0	22,0	00323990
MF 35 × 2	2,0	33,0	170	25	28,0	22,0	00324000
MF 35 × 3	3,0	32,0	200	45	28,0	22,0	00324010
MF 36 × 1	1,0	35,0	170	25	28,0	22,0	00324020
MF 36 × 1,5	1,5	34,5	170	25	28,0	22,0	00324030
MF 36 × 2	2,0	34,0	170	25	28,0	22,0	00324040
MF 36 × 3	3,0	33,0	200	45	28,0	22,0	00324050
MF 38 × 1	1,0	37,0	170	25	28,0	22,0	00324060
MF 38 × 1,5	1,5	36,5	170	25	28,0	22,0	00324070
MF 38 × 2	2,0	36,0	170	25	28,0	22,0	00324080
MF 38 × 3	3,0	35,0	200	30	28,0	22,0	00324090
MF 39 × 1,5	1,5	37,5	170	25	32,0	24,0	00324100
MF 39 × 2	2,0	37,0	170	25	32,0	24,0	00324110
MF 39 × 3	3,0	36,0	200	30	32,0	24,0	00324120
MF 40 × 1,5	1,5	38,5	170	25	32,0	24,0	00324130
MF 40 × 2	2,0	38,0	170	25	32,0	24,0	00324140
MF 40 × 3	3,0	37,0	200	30	32,0	24,0	00324150
MF 42 × 1,5	1,5	40,5	170	25	32,0	24,0	00324160
MF 42 × 2	2,0	40,0	170	25	32,0	24,0	00324170
MF 42 × 3	3,0	39,0	200	30	32,0	24,0	00324180
MF 42 × 4	4,0	38,0	225	30	32,0	24,0	00324190
MF 45 × 1,5	1,5	43,5	180	27	36,0	29,0	00324200
MF 45 × 2	2,0	43,0	180	27	36,0	29,0	00324210
MF 45 × 3	3,0	42,0	200	30	36,0	29,0	00324220
MF 45 × 4	4,0	41,0	225	30	36,0	29,0	00324230

							Арт.-Нр.
MF 48 × 1,5	1,5	46,5	190	27	36,0	29,0	00324240
MF 48 × 2	2,0	46,0	190	27	36,0	29,0	00324250
MF 48 × 3	3,0	45,0	225	33	36,0	29,0	00324260
MF 48 × 4	4,0	44,0	225	33	36,0	29,0	00324270
MF 50 × 1,5	1,5	48,5	190	27	36,0	29,0	00324280
MF 50 × 2	2,0	48,0	190	27	36,0	29,0	00324290
MF 50 × 3	3,0	47,0	225	33	36,0	29,0	00324300
MF 50 × 4	4,0	46,0	225	33	36,0	29,0	00324310
MF 52 × 1,5	1,5	50,5	190	27	40,0	32,0	00324320
MF 52 × 2	2,0	50,0	190	27	40,0	32,0	00324330
MF 52 × 3	3,0	49,0	225	33	40,0	32,0	00324340
MF 52 × 4	4,0	48,0	225	33	36,0	29,0	00324350

							Арт.-Нр.
MF 10 × 0,5	0,5	9,5	90	20	7,0	5,5	02201450
MF 10 × 0,75	0,75	9,25	90	20	7,0	5,5	02201460
MF 10 × 1	1,0	9,0	90	20	7,0	5,5	02201470
MF 10 × 1,25	1,25	8,8	100	20	7,0	5,5	02201480
MF 11 × 0,5	0,5	10,5	90	20	8,0	6,2	02201490
MF 11 × 0,75	0,75	10,25	90	20	8,0	6,2	02201500
MF 11 × 1	1,0	10,0	90	20	8,0	6,2	02201510
MF 11 × 1,25	1,25	9,75	90	20	8,0	6,2	02201520
MF 12 × 0,5	0,5	11,5	100	22	9,0	7,0	02201530
MF 12 × 0,75	0,75	11,25	100	22	9,0	7,0	02201540
MF 12 × 1	1,0	11,0	100	22	9,0	7,0	02201550
MF 12 × 1,25	1,25	10,8	100	22	9,0	7,0	02201560
MF 12 × 1,5	1,5	10,5	100	22	9,0	7,0	02201570
MF 13 × 0,5	0,5	12,5	100	22	11,0	9,0	02201580
MF 13 × 0,75	0,75	12,25	100	22	11,0	9,0	02201590
MF 13 × 1	1,0	12,0	100	22	11,0	9,0	02201600
MF 13 × 1,25	1,25	11,75	100	22	11,0	9,0	02201610
MF 13 × 1,5	1,5	11,5	100	22	11,0	9,0	02201620
MF 14 × 0,5	0,5	13,5	100	22	11,0	9,0	02201630
MF 14 × 0,75	0,75	13,25	100	22	11,0	9,0	02201640
MF 14 × 1	1,0	13,0	100	22	11,0	9,0	02201650
MF 14 × 1,25	1,25	12,8	100	22	11,0	9,0	02201660
MF 14 × 1,5	1,5	12,5	100	22	11,0	9,0	02201670
MF 15 × 0,5	0,5	14,5	100	22	12,0	9,0	02201680
MF 15 × 0,75	0,75	14,25	100	22	12,0	9,0	02201690
MF 15 × 1	1,0	14,0	100	22	12,0	9,0	02201700
MF 15 × 1,25	1,25	13,8	100	22	12,0	9,0	02201710
MF 15 × 1,5	1,5	13,5	100	22	12,0	9,0	02201720
MF 16 × 0,5	0,5	15,5	100	22	12,0	9,0	02201730
MF 16 × 0,75	0,75	15,25	100	22	12,0	9,0	02201740
MF 16 × 1	1,0	15,0	100	22	12,0	9,0	02201750
MF 16 × 1,25	1,25	14,75	100	22	12,0	9,0	02201760
MF 16 × 1,5	1,5	14,5	100	22	12,0	9,0	02201770
MF 17 × 0,75	0,75	16,25	100	22	12,0	9,0	02201780
MF 17 × 1	1,0	16,0	100	22	12,0	9,0	02201790
MF 17 × 1,5	1,5	15,5	100	22	12,0	9,0	02201810
MF 18 × 0,5	0,5	17,5	110	25	14,0	11,0	02201820
MF 18 × 0,75	0,75	17,25	110	25	14,0	11,0	02201830
MF 18 × 1	1,0	17,0	110	25	14,0	11,0	02201840
MF 18 × 1,25	1,25	16,75	110	25	14,0	11,0	02201850
MF 18 × 1,5	1,5	16,5	110	25	14,0	11,0	02201860
MF 18 × 2	2,0	16,0	125	34	14,0	11,0	02201870
MF 19 × 1	1,0	18,0	125	25	14,0	11,0	02201880
MF 19 × 1,5	1,5	17,5	125	25	14,0	11,0	02201890

МАШИННЫЙ МЕТЧИК

ТЕХНИЧЕСКАЯ ИНФОРМАЦИЯ



Норма	DIN 374	Вид отверстия	сквозное < 1.1/2xd
Резьба	MF	Направление	правый
Материал	HSSE-G	Класс точности	6h
Форма	Форма А	Обр. Материал	Сталь

Машинный метчик с проходным хвостовиком, 6–8 Витков резьбы

							Арт.-Нр.
MF 3 × 0,35	0,35	2,65	56	8	2,2	—	02201200
MF 3,5 × 0,35	0,35	3,15	56	8	2,5	2,1	02201220
MF 4 × 0,35	0,35	3,65	63	10	2,8	2,1	02201230
MF 4 × 0,5	0,5	3,5	63	10	2,8	2,7	02201240
MF 4,5 × 0,5	0,5	4,0	70	12	3,5	2,7	02201260
MF 5 × 0,5	0,5	4,5	70	12	3,5	2,7	02201280
MF 5 × 0,75	0,75	4,25	70	12	3,5	2,7	02201290
MF 6 × 0,5	0,5	5,5	80	14	4,5	3,4	02201320
MF 6 × 0,75	0,75	5,25	80	14	4,5	3,4	02201330
MF 7 × 0,5	0,5	6,5	80	14	5,5	4,3	02201350
MF 7 × 0,75	0,75	6,25	80	14	5,5	4,3	02201360
MF 8 × 0,5	0,5	7,5	80	18	6,0	4,9	02201380
MF 8 × 0,75	0,75	7,25	80	18	6,0	4,9	02201390
MF 8 × 1	1,0	7,0	90	22	6,0	4,9	02201400
MF 8 × 1,5	1,5	6,5	90	22	6,0	4,9	02201410
MF 9 × 0,5	0,5	8,5	90	20	7,0	5,5	02201420
MF 9 × 0,75	0,75	8,25	90	20	7,0	5,5	02201430
MF 9 × 1	1,0	8,0	90	22	7,0	5,5	02201440

							Арт.-Нр.
MF 20 × 0,5	0,5	19,5	125	25	16,0	12,0	02201910
MF 20 × 0,75	0,75	19,25	125	25	16,0	12,0	02201920
MF 20 × 1	1,0	19,0	125	25	16,0	12,0	02201930
MF 20 × 1,25	1,25	18,75	125	25	16,0	12,0	02201940
MF 20 × 1,5	1,5	18,5	125	25	16,0	12,0	02201950
MF 20 × 2	2,0	18,0	140	34	16,0	12,0	02201960
MF 21 × 1	1,0	20,0	125	25	16,0	12,0	02201980
MF 21 × 1,5	1,5	19,5	125	25	16,0	12,0	02202000
MF 22 × 0,5	0,5	21,5	125	20	18,0	14,5	02202010
MF 22 × 0,75	0,75	21,25	125	25	18,0	14,5	02202020
MF 22 × 1	1,0	21,0	125	25	18,0	14,5	02202030
MF 22 × 1,25	1,25	20,75	125	25	18,0	14,5	02202040
MF 22 × 1,5	1,5	20,5	125	25	18,0	14,5	02202050
MF 22 × 2	2,0	20,0	140	34	18,0	14,5	02202060
MF 23 × 1	1,0	22,0	125	28	18,0	14,5	02202070
MF 23 × 1,5	1,5	21,5	125	28	18,0	14,5	02202080
MF 24 × 0,5	0,5	23,5	125	28	18,0	14,5	02202090
MF 24 × 0,75	0,75	23,25	140	28	18,0	14,5	02202100
MF 24 × 1	1,0	23,0	140	28	18,0	14,5	02202110
MF 24 × 1,25	1,25	22,75	140	28	18,0	14,5	02202120
MF 24 × 1,5	1,5	22,5	140	28	18,0	14,5	02202130
MF 24 × 2	2,0	22,0	140	28	18,0	14,5	02202140
MF 25 × 1	1,0	24,0	140	28	18,0	14,5	02202150
MF 25 × 1,5	1,5	23,5	140	28	18,0	14,5	02202170
MF 25 × 2	2,0	23,0	140	28	18,0	14,5	02202180
MF 26 × 1	1,0	25,0	140	28	18,0	14,5	02202190
MF 26 × 1,25	1,25	24,75	140	28	18,0	14,5	02202200
MF 26 × 1,5	1,5	24,5	140	28	18,0	14,5	02202210
MF 26 × 2	2,0	24,0	140	28	18,0	14,5	02202220
MF 27 × 1	1,0	26,0	150	28	20,0	16,0	02202230
MF 27 × 1,5	1,5	25,5	140	28	20,0	16,0	02202240
MF 27 × 2	2,0	25,0	150	28	20,0	16,0	02202250
MF 28 × 1	1,0	27,0	150	28	20,0	16,0	02202260
MF 28 × 1,5	1,5	26,5	150	28	20,0	16,0	02202270
MF 28 × 2	2,0	26,0	140	28	20,0	16,0	02202280
MF 30 × 1	1,0	29,0	150	28	22,0	18,0	02202290
MF 30 × 1,5	1,5	28,5	150	28	22,0	18,0	02202300
MF 30 × 2	2,0	28,0	150	28	22,0	18,0	02202310
MF 30 × 3	3,0	27,0	180	45	22,0	18,0	02202320
MF 32 × 1	1,0	31,0	150	30	22,0	18,0	02202330
MF 32 × 1,5	1,5	30,5	150	30	22,0	18,0	02202340
MF 32 × 2	2,0	30,0	150	30	22,0	18,0	02202350
MF 32 × 3	3,0	29,0	180	50	22,0	18,0	02202360
MF 33 × 1	1,0	32,0	150	30	25,0	20,0	02202370

							Арт.-Нр.
MF 33 × 1,5	1,5	31,5	160	30	25,0	20,0	02202380
MF 33 × 2	2,0	31,0	160	30	25,0	20,0	02202390
MF 33 × 3	3,0	30,0	180	50	25,0	20,0	02202400
MF 34 × 1	1,0	33,0	170	30	28,0	22,0	02202410
MF 34 × 1,5	1,5	32,5	170	30	28,0	22,0	02202420
MF 34 × 2	2,0	32,0	170	30	28,0	22,0	02202430
MF 34 × 3	3,0	31,0	200	56	28,0	22,0	02202440
MF 35 × 1	1,0	34,0	170	30	28,0	22,0	02202450
MF 35 × 1,5	1,5	33,5	170	30	28,0	22,0	02202460
MF 35 × 2	2,0	33,0	170	30	28,0	22,0	02202470
MF 35 × 3	3,0	32,0	200	56	28,0	22,0	02202480
MF 36 × 1	1,0	35,0	170	30	28,0	22,0	02202490
MF 36 × 1,5	1,5	34,5	170	30	28,0	22,0	02202500
MF 36 × 2	2,0	34,0	170	30	28,0	22,0	02202510
MF 36 × 3	3,0	33,0	200	56	28,0	22,0	02202520
MF 38 × 1	1,0	37,0	170	30	28,0	22,0	02202530
MF 38 × 1,5	1,5	36,5	170	30	28,0	22,0	02202540
MF 38 × 2	2,0	36,0	170	30	28,0	22,0	02202550
MF 38 × 3	3,0	35,0	200	56	28,0	22,0	02202560
MF 39 × 1,5	1,5	37,5	170	30	32,0	24,0	02202570
MF 39 × 2	2,0	37,0	170	30	32,0	24,0	02202580
MF 39 × 3	3,0	36,0	200	60	32,0	24,0	02202590
MF 40 × 1	1,0	39,0	170	30	32,0	24,0	02202600
MF 40 × 1,5	1,5	38,5	170	30	32,0	24,0	02202610
MF 40 × 2	2,0	38,0	170	30	32,0	24,0	02202620
MF 40 × 3	3,0	37,0	200	60	32,0	24,0	02202630
MF 42 × 1,5	1,5	40,5	170	30	32,0	24,0	02202640
MF 42 × 2	2,0	40,0	170	30	32,0	24,0	02202650
MF 42 × 3	3,0	39,0	200	60	32,0	24,0	02202660
MF 42 × 4	4,0	38,0	225	60	32,0	24,0	02202670
MF 45 × 1	1,0	44,0	180	32	36,0	29,0	02202680
MF 45 × 1,5	1,5	43,5	180	32	36,0	29,0	02202690
MF 45 × 2	2,0	43,0	180	32	36,0	29,0	02202700
MF 45 × 3	3,0	42,0	200	50	36,0	29,0	02202710
MF 45 × 4	4,0	41,0	225	65	36,0	29,0	02202720
MF 48 × 1	1,0	47,0	190	32	36,0	29,0	02202730
MF 48 × 1,5	1,5	46,5	190	32	36,0	29,0	02202740
MF 48 × 2	2,0	46,0	190	32	36,0	29,0	02202750
MF 48 × 3	3,0	45,0	225	50	36,0	29,0	02202760
MF 48 × 4	4,0	44,0	225	70	36,0	29,0	02202770
MF 50 × 1	1,0	49,0	190	32	36,0	29,0	02202780
MF 50 × 1,5	1,5	48,5	190	32	36,0	29,0	02202790
MF 50 × 2	2,0	48,0	190	32	36,0	29,0	02202800
MF 50 × 3	3,0	47,0	225	50	36,0	29,0	02202810

							Арт.-Нр.
MF 50 × 4	4,0	46,0	225	70	36,0	29,0	02202820
MF 52 × 1	1,0	51,0	190	32	40,0	32,0	02202830
MF 52 × 1,5	1,5	50,5	190	32	40,0	32,0	02202840
MF 52 × 2	2,0	50,0	190	32	40,0	32,0	02202850
MF 52 × 3	3,0	49,0	225	50	40,0	32,0	02202860
MF 52 × 4	4,0	48,0	225	70	36,0	29,0	02202870

							Арт.-Нр.
MF 13 × 0,75	0,75	12,25	100	22	11,0	9,0	02204590
MF 13 × 1	1,0	12,0	100	22	11,0	9,0	02204600
MF 13 × 1,25	1,25	11,75	100	22	11,0	9,0	02204610
MF 13 × 1,5	1,5	11,5	100	22	11,0	9,0	02204620
MF 14 × 0,5	0,5	13,5	100	22	11,0	9,0	02204630
MF 14 × 0,75	0,75	13,25	100	22	11,0	9,0	02204640
MF 14 × 1	1,0	13,0	100	22	11,0	9,0	02204650
MF 14 × 1,25	1,25	12,75	100	22	11,0	9,0	02204660
MF 14 × 1,5	1,5	12,5	100	22	11,0	9,0	02204670
MF 15 × 0,5	0,5	14,5	100	22	12,0	9,0	02204680
MF 15 × 0,75	0,75	14,25	100	22	12,0	9,0	02204690
MF 15 × 1	1,0	14,0	100	22	12,0	9,0	02204700
MF 15 × 1,25	1,25	13,8	100	22	12,0	9,0	02204710
MF 15 × 1,5	1,5	13,5	100	22	12,0	9,0	02204720
MF 16 × 0,5	0,5	15,5	100	22	12,0	9,0	02204730
MF 16 × 0,75	0,75	15,25	100	22	12,0	9,0	02204740
MF 16 × 1	1,0	15,0	100	22	12,0	9,0	02204750
MF 16 × 1,25	1,25	14,75	100	22	12,0	9,0	02204760
MF 16 × 1,5	1,5	14,5	100	22	12,0	9,0	02204770
MF 17 × 0,75	0,75	16,25	100	22	12,0	9,0	02204780
MF 17 × 1	1,0	16,0	100	22	12,0	9,0	02204790
MF 17 × 1,5	1,5	15,5	100	22	12,0	9,0	02204800
MF 18 × 0,75	0,75	17,25	110	25	14,0	11,0	02204810
MF 18 × 1	1,0	17,0	110	25	14,0	11,0	02204840
MF 18 × 1,25	1,25	16,75	110	25	14,0	11,0	02204850
MF 18 × 1,5	1,5	16,5	110	25	14,0	11,0	02204860
MF 18 × 2	2,0	16,0	125	34	14,0	11,0	02204870
MF 20 × 0,75	0,75	19,25	125	25	16,0	12,0	02204880
MF 20 × 1	1,0	19,0	125	25	16,0	12,0	02204930
MF 20 × 1,25	1,25	18,75	125	25	16,0	12,0	02204940
MF 20 × 1,5	1,5	18,5	125	25	16,0	12,0	02204950
MF 20 × 2	2,0	18,0	140	34	16,0	12,0	02204960
MF 21 × 1	1,0	20,0	125	25	16,0	12,0	02204970
MF 21 × 1,5	1,5	19,5	125	25	16,0	12,0	02204980
MF 22 × 0,75	0,75	21,25	125	25	18,0	14,5	02204990
MF 22 × 1	1,0	21,0	125	25	18,0	14,5	02206030
MF 22 × 1,25	1,25	20,75	125	25	18,0	14,5	02206040
MF 22 × 1,5	1,5	20,5	125	25	18,0	14,5	02206050
MF 22 × 2	2,0	20,0	140	34	18,0	14,5	02206060
MF 23 × 1	1,0	22,0	125	28	18,0	14,5	02206070
MF 23 × 1,5	1,5	21,5	125	28	18,0	14,5	02206080
MF 24 × 0,75	0,75	23,25	140	28	18,0	14,5	02206090
MF 24 × 1	1,0	23,0	140	28	18,0	14,5	02206110
MF 24 × 1,25	1,25	22,75	140	28	18,0	14,5	02206120

МАШИННЫЙ МЕТЧИК

ТЕХНИЧЕСКАЯ ИНФОРМАЦИЯ



Норма	DIN 374	Вид отверстия	сквозное < 1.1/2xd
Резьба	MF	Направление	правый
Материал	HSSE-G	Класс точности	6h
Форма	Форма В	Обр. Материал	Сталь

Машинный метчик с проходным хвостовиком, 4–5 витков резьбы, со спиральной подточкой (стружколом)

							Арт.-Нр.
MF 3 × 0,35	0,35	2,65	56	8	2,2	1,9	02204260
MF 4 × 0,5	0,5	3,5	63	10	2,8	2,1	02204270
MF 5 × 0,5	0,5	4,5	70	12	3,5	2,7	02204280
MF 5 × 0,75	0,75	4,25	70	12	3,5	2,7	02204290
MF 6 × 0,5	0,5	5,5	80	14	4,5	3,4	02204320
MF 6 × 0,75	0,75	5,25	80	14	4,5	3,4	02204330
MF 7 × 0,75	0,75	6,25	80	14	5,5	4,3	02204340
MF 8 × 0,5	0,5	7,5	80	18	6,0	4,9	02204350
MF 8 × 0,75	0,75	7,25	80	18	6,0	4,9	02204390
MF 8 × 1	1,0	7,0	90	22	6,0	4,9	02204400
MF 9 × 1	1,0	8,0	90	22	7,0	5,5	02204440
MF 10 × 0,5	0,5	9,5	90	20	7,0	5,5	02204450
MF 10 × 0,75	0,75	9,25	90	20	7,0	5,5	02204460
MF 10 × 1	1,0	9,0	90	20	7,0	5,5	02204470
MF 10 × 1,25	1,25	8,75	100	20	7,0	5,5	02204480
MF 11 × 0,75	0,75	10,25	90	20	8,0	6,2	02204490
MF 11 × 1	1,0	10,0	90	20	8,0	6,2	02204510
MF 11 × 1,25	1,25	9,75	90	20	8,0	6,2	02204520
MF 12 × 0,5	0,5	11,5	100	22	9,0	7,0	02204530
MF 12 × 0,75	0,75	11,25	100	22	9,0	7,0	02204540
MF 12 × 1	1,0	11,0	100	22	9,0	7,0	02204550
MF 12 × 1,25	1,25	10,75	100	22	9,0	7,0	02204560
MF 12 × 1,5	1,5	10,5	100	22	9,0	7,0	02204570
MF 13 × 0,5	0,5	12,5	100	22	11,0	9,0	02204580

							Арт.-Нр.
MF 24 × 1,5	1,5	22,5	140	28	18,0	14,5	02206130
MF 24 × 2	2,0	22,0	140	28	18,0	14,5	02206140
MF 25 × 1	1,0	24,0	140	28	18,0	14,5	02206150
MF 25 × 1,5	1,5	23,5	140	28	18,0	14,5	02206170
MF 25 × 2	2,0	23,0	140	28	18,0	14,5	02206180
MF 26 × 1	1,0	25,0	140	28	18,0	14,5	02206200
MF 26 × 1,5	1,5	24,5	140	28	18,0	14,5	02206210
MF 26 × 2	2,0	24,0	140	28	18,0	14,5	02206220
MF 27 × 1	1,0	26,0	150	28	20,0	16,0	02206230
MF 27 × 1,5	1,5	25,5	140	28	20,0	16,0	02206240
MF 27 × 2	2,0	25,0	140	28	20,0	16,0	02206250
MF 28 × 1	1,0	27,0	140	28	20,0	16,0	02206260
MF 28 × 1,5	1,5	26,5	140	28	20,0	16,0	02206270
MF 28 × 2	2,0	26,0	140	28	20,0	16,0	02206280
MF 30 × 1	1,0	29,0	150	28	22,0	18,0	02206290
MF 30 × 1,5	1,5	28,5	150	28	22,0	18,0	02206300
MF 30 × 2	2,0	28,0	150	28	22,0	18,0	02206310
MF 30 × 3	3,0	27,0	180	45	22,0	18,0	02206320
MF 32 × 1	1,0	31,0	150	30	22,0	18,0	02206330
MF 32 × 1,5	1,5	30,5	150	30	22,0	18,0	02206340
MF 32 × 2	2,0	30,0	150	30	22,0	18,0	02206350
MF 32 × 3	3,0	29,0	180	50	22,0	18,0	02206360
MF 33 × 1	1,0	32,0	150	30	25,0	20,0	02206370
MF 33 × 1,5	1,5	31,5	160	30	25,0	20,0	02206380
MF 33 × 2	2,0	31,0	160	30	25,0	20,0	02206390
MF 33 × 3	3,0	30,0	180	50	25,0	20,0	02206400
MF 34 × 1	1,0	33,0	170	30	28,0	22,0	02206410
MF 34 × 1,5	1,5	32,5	170	30	28,0	22,0	02206420
MF 34 × 2	2,0	32,0	170	30	28,0	22,0	02206430
MF 34 × 3	3,0	31,0	200	56	28,0	22,0	02206440
MF 35 × 1	1,0	34,0	170	30	28,0	22,0	02206450
MF 35 × 1,5	1,5	33,5	170	30	28,0	22,0	02206460
MF 35 × 2	2,0	33,0	170	30	28,0	22,0	02206470
MF 35 × 3	3,0	32,0	200	56	28,0	22,0	02206480
MF 36 × 1	1,0	35,0	170	30	28,0	22,0	02206490
MF 36 × 1,5	1,5	34,5	170	30	28,0	22,0	02206500
MF 36 × 2	2,0	34,0	170	30	28,0	22,0	02206510
MF 36 × 3	3,0	33,0	200	56	28,0	22,0	02206520
MF 38 × 1	1,0	37,0	170	30	28,0	22,0	02206530
MF 38 × 1,5	1,5	36,5	170	30	28,0	22,0	02206540
MF 38 × 2	2,0	36,0	170	30	28,0	22,0	02206550
MF 38 × 3	3,0	35,0	200	56	28,0	22,0	02206560
MF 39 × 1,5	1,5	37,5	170	30	32,0	24,0	02206570
MF 39 × 2	2,0	37,0	170	30	32,0	24,0	02206580

							Арт.-Нр.
MF 39 × 3	3,0	36,0	200	60	32,0	24,0	02206590
MF 40 × 1,5	1,5	38,5	170	30	32,0	24,0	02206610
MF 40 × 2	2,0	38,0	170	30	32,0	24,0	02206620
MF 40 × 3	3,0	37,0	200	60	32,0	24,0	02206630
MF 42 × 1,5	1,5	40,5	170	30	32,0	24,0	02206640
MF 42 × 2	2,0	40,0	170	30	32,0	24,0	02206650
MF 42 × 3	3,0	39,0	200	60	32,0	24,0	02206660
MF 42 × 4	4,0	38,0	225	60	32,0	24,0	02206670
MF 45 × 1,5	1,5	43,5	180	32	36,0	29,0	02206690
MF 45 × 2	2,0	43,0	180	32	36,0	29,0	02206700
MF 45 × 3	3,0	42,0	200	50	36,0	29,0	02206710
MF 45 × 4	4,0	41,0	225	65	36,0	29,0	02206720
MF 48 × 1,5	1,5	46,5	190	32	36,0	29,0	02206740
MF 48 × 2	2,0	46,0	190	32	36,0	29,0	02206750
MF 48 × 3	3,0	45,0	225	50	36,0	29,0	02206760
MF 48 × 4	4,0	44,0	225	70	36,0	29,0	02206770
MF 50 × 1,5	1,5	48,5	190	32	36,0	29,0	02206790
MF 50 × 2	2,0	48,0	190	32	36,0	29,0	02206800
MF 50 × 3	3,0	47,0	225	50	36,0	29,0	02206810
MF 50 × 4	4,0	46,0	225	70	36,0	29,0	02206820
MF 52 × 1,5	1,5	50,5	190	32	40,0	32,0	02206840
MF 52 × 2	2,0	50,0	190	32	40,0	32,0	02206850
MF 52 × 3	3,0	49,0	225	50	40,0	32,0	02206860
MF 52 × 4	4,0	48,0	225	70	36,0	29,0	02206870

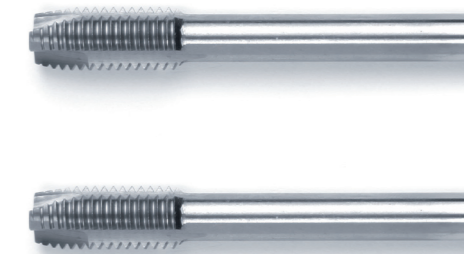

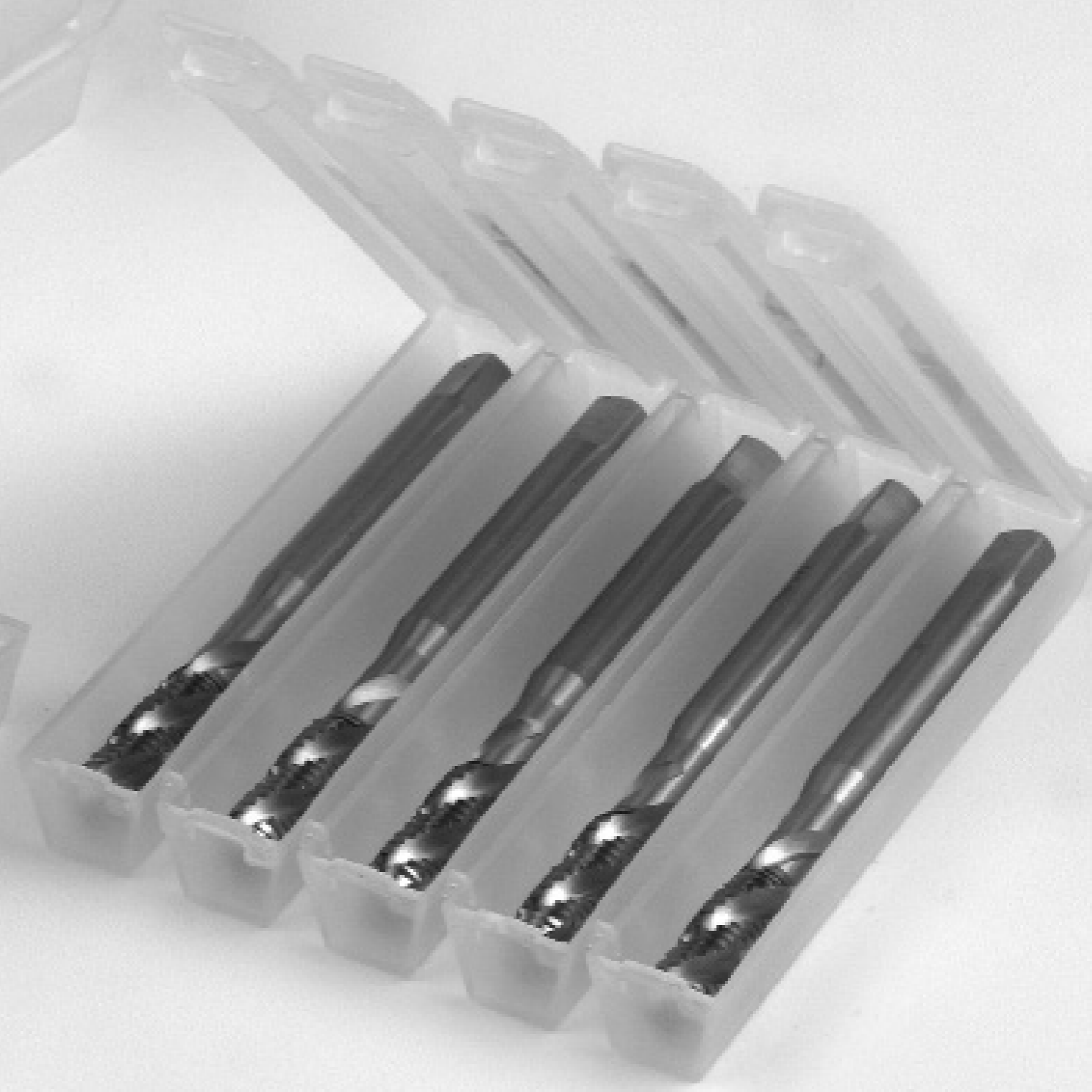

МАШИННЫЙ МЕТЧИК

ТЕХНИЧЕСКАЯ ИНФОРМАЦИЯ



Норма	DIN 374	Вид отверстия	сквозное < 1.1/2хd
Резьба	MF	Направление	правый
Материал	HSSE-G / VAP	Класс точности	6h
Форма	Форма В	Обр. Материал	VA-Сталь

Машинный метчик с проходным хвостовиком, 4–5 витков резьбы, со спиральной подточкой (стружколом), вапоризированный

							Арт.-Нр.
MF 3 × 0,35	0,35	2,65	56	8	2,2	1,9	02205280
MF 4 × 0,5	0,5	3,5	63	10	2,8	2,1	02205290
MF 5 × 0,5	0,5	4,5	70	12	3,5	2,7	02205300
MF 5 × 0,75	0,75	4,25	70	12	3,5	2,7	02205310
MF 6 × 0,5	0,5	5,5	80	14	4,5	3,4	02205320
MF 6 × 0,75	0,75	5,25	80	14	4,5	3,4	02205330
MF 7 × 0,75	0,75	6,25	80	14	5,5	4,3	02205340
MF 8 × 0,5	0,5	7,5	80	18	6,0	4,9	02205350
MF 8 × 0,75	0,75	7,25	80	18	6,0	4,9	02205390
MF 8 × 1	1,0	7,0	90	22	6,0	4,9	02205400
MF 9 × 1	1,0	8,0	90	22	7,0	5,5	02205410
MF 10 × 0,5	0,5	9,5	90	20	7,0	5,5	02205420
MF 10 × 0,75	0,75	9,25	90	20	7,0	5,5	02205430
MF 10 × 1	1,0	9,0	90	20	7,0	5,5	02205470
MF 10 × 1,25	1,25	8,75	100	20	7,0	5,5	02205480
MF 11 × 0,75	0,75	10,25	90	20	8,0	6,2	02205490
MF 11 × 1	1,0	10,0	90	20	8,0	6,2	02205500
MF 11 × 1,25	1,25	9,75	90	20	8,0	6,2	02205510
MF 12 × 0,5	0,5	11,5	100	22	9,0	7,0	02205520
MF 12 × 0,75	0,75	11,25	100	22	9,0	7,0	02205530
MF 12 × 1	1,0	11,0	100	22	9,0	7,0	02205540
MF 12 × 1,25	1,25	10,75	100	22	9,0	7,0	02205550
MF 12 × 1,5	1,5	10,5	100	22	9,0	7,0	02205570
MF 13 × 0,5	0,5	12,5	100	22	11,0	9,0	02205580
MF 13 × 0,75	0,75	12,25	100	22	11,0	9,0	02205590
MF 13 × 1	1,0	12,0	100	22	11,0	9,0	02205600
MF 13 × 1,25	1,25	11,75	100	22	11,0	9,0	02205610
MF 13 × 1,5	1,5	11,5	100	22	11,0	9,0	02205620
MF 14 × 0,5	0,5	13,5	100	22	11,0	9,0	02205630
MF 14 × 0,75	0,75	13,25	100	22	11,0	9,0	02205640
MF 14 × 1	1,0	13,0	100	22	11,0	9,0	02205650
MF 14 × 1,25	1,25	12,75	100	22	11,0	9,0	02205660
MF 14 × 1,5	1,5	12,5	100	22	11,0	9,0	02205670
MF 15 × 0,5	0,5	14,5	100	22	12,0	9,0	02205680
MF 15 × 0,75	0,75	14,25	100	22	12,0	9,0	02205690
MF 15 × 1	1,0	14,0	100	22	12,0	9,0	02205700

							Арт.-Нр.
MF 15 × 1,25	1,25	13,8	100	22	12,0	9,0	02205710
MF 15 × 1,5	1,5	13,5	100	22	12,0	9,0	02205720
MF 16 × 0,5	0,5	15,5	100	22	12,0	9,0	02205730
MF 16 × 0,75	0,75	15,25	100	22	12,0	9,0	02205740
MF 16 × 1	1,0	15,0	100	22	12,0	9,0	02205750
MF 16 × 1,25	1,25	14,75	100	22	12,0	9,0	02205760
MF 16 × 1,5	1,5	14,5	100	22	12,0	9,0	02205770
MF 17 × 0,75	0,75	16,25	100	22	12,0	9,0	02205780
MF 17 × 1	1,0	16,0	100	22	12,0	9,0	02205790
MF 17 × 1,5	1,5	15,5	100	22	12,0	9,0	02205800
MF 18 × 0,75	0,75	17,25	110	25	14,0	11,0	02205810
MF 18 × 1	1,0	17,0	110	25	14,0	11,0	02205820
MF 18 × 1,25	1,25	16,75	110	25	14,0	11,0	02205830
MF 18 × 1,5	1,5	16,5	110	25	14,0	11,0	02205860
MF 18 × 2	2,0	16,0	125	34	14,0	11,0	02205870
MF 20 × 0,75	0,75	19,25	125	25	16,0	12,0	02205880
MF 20 × 1	1,0	19,0	125	25	16,0	12,0	02205890
MF 20 × 1,25	1,25	18,75	125	25	16,0	12,0	02205900
MF 20 × 1,5	1,5	18,5	125	25	16,0	12,0	02205950
MF 20 × 2	2,0	18,0	140	34	16,0	12,0	02205960
MF 21 × 1	1,0	20,0	125	25	16,0	12,0	02205970
MF 21 × 1,5	1,5	19,5	125	25	16,0	12,0	02205980
MF 22 × 0,75	0,75	21,25	125	25	18,0	14,5	02205990
MF 22 × 1	1,0	21,0	125	25	18,0	14,5	02224010
MF 22 × 1,25	1,25	20,75	125	25	18,0	14,5	02224020
MF 22 × 1,5	1,5	20,5	125	25	18,0	14,5	02224030
MF 22 × 2	2,0	20,0	140	34	18,0	14,5	02224040
MF 23 × 1	1,0	22,0	125	28	18,0	14,5	02224050
MF 23 × 1,5	1,5	21,5	125	28	18,0	14,5	02224060
MF 24 × 0,75	0,75	23,25	140	28	18,0	14,5	02224070
MF 24 × 1	1,0	23,0	140	28	18,0	14,5	02224080
MF 24 × 1,25	1,25	22,75	140	28	18,0	14,5	02224090
MF 24 × 1,5	1,5	22,5	140	28	18,0	14,5	02224100
MF 24 × 2	2,0	22,0	140	28	18,0	14,5	02224110



МАШИННЫЙ МЕТЧИК



ТЕХНИЧЕСКАЯ ИНФОРМАЦИЯ

Норма	DIN 374	Вид отверстия	глухое < 2хd
Резьба	MF	Направление	правый
Материал	HSSE-G	Класс точности	6h
Форма	Форма C / RSP 15°	Обр. Материал	Сталь

Машинный метчик с проходным хвостовиком, со спиральной канавкой 15 градусов, 2-3 витка резьбы

Метчик	h	h ₁	h ₂	h ₃	h ₄	h ₅	Арт.-Нр.
MF 3 × 0,35	0,35	2,65	56	8	2,2	1,9	02213260
MF 4 × 0,5	0,5	3,5	63	8	2,8	2,1	02213270
MF 5 × 0,5	0,5	4,5	70	8	3,5	2,7	02213280
MF 5 × 0,75	0,75	4,25	70	8	3,5	2,7	02213290
MF 6 × 0,5	0,5	5,5	80	12	4,5	3,4	02213320
MF 6 × 0,75	0,75	5,25	80	12	4,5	3,4	02213330
MF 7 × 0,75	0,75	6,25	80	12	5,5	4,3	02213360
MF 8 × 0,5	0,5	7,5	80	12	6,0	4,9	02213380
MF 8 × 0,75	0,75	7,25	80	12	6,0	4,9	02213390
MF 8 × 1	1,0	7,0	90	16	6,0	4,9	02213400
MF 9 × 1	1,0	8,0	90	16	7,0	5,5	02213440
MF 10 × 0,5	0,5	9,5	90	16	7,0	5,5	02213450
MF 10 × 0,75	0,75	9,25	90	16	7,0	5,5	02213460
MF 10 × 1	1,0	9,0	90	16	7,0	5,5	02213470
MF 10 × 1,25	1,25	8,75	100	16	7,0	5,5	02213480
MF 11 × 0,75	0,75	10,25	90	16	8,0	6,2	02213500
MF 11 × 1	1,0	10,0	90	16	8,0	6,2	02213510
MF 11 × 1,25	1,25	9,75	90	16	8,0	6,2	02213520
MF 12 × 0,5	0,5	11,5	100	16	9,0	7,0	02213530
MF 12 × 0,75	0,75	11,25	100	16	9,0	7,0	02213540
MF 12 × 1	1,0	11,0	100	16	9,0	7,0	02213550
MF 12 × 1,25	1,25	10,75	100	16	9,0	7,0	02213560
MF 12 × 1,5	1,5	10,5	100	16	9,0	7,0	02213570
MF 13 × 0,5	0,5	12,5	100	16	11,0	9,0	02213580
MF 13 × 0,75	0,75	12,25	100	16	11,0	9,0	02213590
MF 13 × 1	1,0	12,0	100	16	11,0	9,0	02213600
MF 13 × 1,25	1,25	11,75	100	16	11,0	9,0	02213610
MF 13 × 1,5	1,5	11,5	100	16	11,0	9,0	02213620
MF 14 × 0,5	0,5	13,5	100	16	11,0	9,0	02213630
MF 14 × 0,75	0,75	13,25	100	16	11,0	9,0	02213640
MF 14 × 1	1,0	13,0	100	16	11,0	9,0	02213650
MF 14 × 1,25	1,25	12,75	100	16	11,0	9,0	02213660
MF 14 × 1,5	1,5	12,5	100	16	11,0	9,0	02213670
MF 15 × 0,5	0,5	14,5	100	16	12,0	9,0	02213680
MF 15 × 0,75	0,75	14,25	100	16	12,0	9,0	02213690
MF 15 × 1	1,0	14,0	100	16	12,0	9,0	02213700

Метчик	h	h ₁	h ₂	h ₃	h ₄	h ₅	Арт.-Нр.
MF 15 × 1,25	1,25	13,8	100	16	12,0	9,0	02213710
MF 15 × 1,5	1,5	13,5	100	16	12,0	9,0	02213720
MF 16 × 0,5	0,5	15,5	100	16	12,0	9,0	02213730
MF 16 × 0,75	0,75	15,25	100	16	12,0	9,0	02213740
MF 16 × 1	1,0	15,0	100	16	12,0	9,0	02213750
MF 16 × 1,25	1,25	14,75	100	16	12,0	9,0	02213760
MF 16 × 1,5	1,5	14,5	100	16	12,0	9,0	02213770
MF 17 × 0,75	0,75	16,25	100	16	12,0	9,0	02213780
MF 17 × 1	1,0	16,0	100	16	12,0	9,0	02213790
MF 17 × 1,5	1,5	15,5	100	16	12,0	9,0	02213810
MF 18 × 0,75	0,75	17,25	110	20	14,0	11,0	02213830
MF 18 × 1	1,0	17,0	110	20	14,0	11,0	02213840
MF 18 × 1,25	1,25	16,75	110	20	14,0	11,0	02213850
MF 18 × 1,5	1,5	16,5	110	20	14,0	11,0	02213860
MF 18 × 2	2,0	16,0	125	25	14,0	11,0	02213870
MF 20 × 0,75	0,75	19,25	125	20	16,0	12,0	02213920
MF 20 × 1	1,0	19,0	125	20	16,0	12,0	02213930
MF 20 × 1,25	1,25	18,75	125	20	16,0	12,0	02213940
MF 20 × 1,5	1,5	18,5	125	20	16,0	12,0	02213950
MF 20 × 2	2,0	18,0	140	25	16,0	12,0	02213960
MF 21 × 1	1,0	20,0	125	20	16,0	12,0	02213980
MF 21 × 1,5	1,5	19,5	125	20	16,0	12,0	02214000
MF 22 × 0,75	0,75	21,25	125	20	18,0	14,5	02214020
MF 22 × 1	1,0	21,0	125	20	18,0	14,5	02214030
MF 22 × 1,25	1,25	20,75	125	20	18,0	14,5	02214040
MF 22 × 1,5	1,5	20,5	125	20	18,0	14,5	02214050
MF 22 × 2	2,0	20,0	140	25	18,0	14,5	02214060
MF 23 × 1	1,0	22,0	125	20	18,0	14,5	02214070
MF 23 × 1,5	1,5	21,5	125	20	18,0	14,5	02214080
MF 24 × 0,75	0,75	23,25	140	20	18,0	14,5	02214100
MF 24 × 1	1,0	23,0	140	20	18,0	14,5	02214110
MF 24 × 1,25	1,25	22,75	140	20	18,0	14,5	02214120
MF 24 × 1,5	1,5	22,5	140	20	18,0	14,5	02214130
MF 24 × 2	2,0	22,0	140	20	18,0	14,5	02214140
MF 25 × 1	1,0	24,0	140	20	18,0	14,5	02214150
MF 25 × 1,5	1,5	23,5	140	20	18,0	14,5	02214170
MF 25 × 2	2,0	23,0	140	20	18,0	14,5	02214180
MF 26 × 1	1,0	25,0	140	20	18,0	14,5	02214190
MF 26 × 1,5	1,5	24,5	140	20	18,0	14,5	02214210
MF 26 × 2	2,0	24,0	140	20	18,0	14,5	02214220
MF 27 × 1	1,0	26,0	150	20	20,0	16,0	02214230
MF 27 × 1,5	1,5	25,5	140	20	20,0	16,0	02214240
MF 27 × 2	2,0	25,0	140	20	20,0	16,0	02214250
MF 28 × 1	1,0	27,0	140	20	20,0	16,0	02214260

							Арт.-Нр.
MF 28 × 1,5	1,5	26,5	140	20	20,0	16,0	02214270
MF 28 × 2	2,0	26,0	140	20	20,0	16,0	02214280
MF 30 × 1	1,0	29,0	150	22	22,0	18,0	02214290
MF 30 × 1,5	1,5	28,5	150	22	22,0	18,0	02214300
MF 30 × 2	2,0	28,0	150	22	22,0	18,0	02214310
MF 30 × 3	3,0	27,0	180	35	22,0	18,0	02214320
MF 32 × 1	1,0	31,0	150	22	22,0	18,0	02214330
MF 32 × 1,5	1,5	30,5	150	22	22,0	18,0	02214340
MF 32 × 2	2,0	30,0	150	22	22,0	18,0	02214350
MF 32 × 3	3,0	29,0	180	35	22,0	18,0	02214360
MF 33 × 1	1,0	32,0	150	25	25,0	20,0	02214370
MF 33 × 1,5	1,5	31,5	160	25	25,0	20,0	02214380
MF 33 × 2	2,0	31,0	160	25	25,0	20,0	02214390
MF 33 × 3	3,0	30,0	180	35	25,0	20,0	02214400
MF 34 × 1	1,0	33,0	170	25	28,0	22,0	02214410
MF 34 × 1,5	1,5	32,5	170	28	28,0	22,0	02214420
MF 34 × 2	2,0	32,0	170	32	28,0	22,0	02214430
MF 34 × 3	3,0	31,0	200	36	28,0	22,0	02214440
MF 35 × 1	1,0	34,0	170	25	28,0	22,0	02214450
MF 35 × 1,5	1,5	33,5	170	25	28,0	22,0	02214460
MF 35 × 2	2,0	33,0	170	25	28,0	22,0	02214470
MF 35 × 3	3,0	32,0	200	45	28,0	22,0	02214480
MF 36 × 1	1,0	35,0	170	25	28,0	22,0	02214490
MF 36 × 1,5	1,5	34,5	170	25	28,0	22,0	02214500
MF 36 × 2	2,0	34,0	170	25	28,0	22,0	02214510
MF 36 × 3	3,0	33,0	200	45	28,0	22,0	02214520
MF 38 × 1	1,0	37,0	170	25	28,0	22,0	02214530
MF 38 × 1,5	1,5	36,5	170	25	28,0	22,0	02214540
MF 38 × 2	2,0	36,0	170	25	28,0	22,0	02214550
MF 38 × 3	3,0	35,0	200	30	28,0	22,0	02214560
MF 39 × 1,5	1,5	37,5	170	25	32,0	24,0	02214570
MF 39 × 2	2,0	37,0	170	25	32,0	24,0	02214580
MF 39 × 3	3,0	36,0	200	30	32,0	24,0	02214590
MF 40 × 1,5	1,5	38,5	170	25	32,0	24,0	02214610
MF 40 × 2	2,0	38,0	170	25	32,0	24,0	02214620
MF 40 × 3	3,0	37,0	200	30	32,0	24,0	02214630
MF 42 × 1,5	1,5	40,5	170	25	32,0	24,0	02214640
MF 42 × 2	2,0	40,0	170	25	32,0	24,0	02214650
MF 42 × 3	3,0	39,0	200	30	32,0	24,0	02214660
MF 42 × 4	4,0	38,0	225	30	32,0	24,0	02214670
MF 45 × 1,5	1,5	43,5	180	27	36,0	29,0	02214690
MF 45 × 2	2,0	43,0	180	27	36,0	29,0	02214700
MF 45 × 3	3,0	42,0	200	30	36,0	29,0	02214710
MF 45 × 4	4,0	41,0	225	30	36,0	29,0	02214720

							Арт.-Нр.
MF 48 × 1,5	1,5	46,5	190	27	36,0	29,0	02214740
MF 48 × 2	2,0	46,0	190	27	36,0	29,0	02214750
MF 48 × 3	3,0	45,0	225	33	36,0	29,0	02214760
MF 48 × 4	4,0	44,0	225	33	36,0	29,0	02214770
MF 50 × 1,5	1,5	48,5	190	27	36,0	29,0	02214790
MF 50 × 2	2,0	48,0	190	27	36,0	29,0	02214800
MF 50 × 3	3,0	47,0	225	33	36,0	29,0	02214810
MF 50 × 4	4,0	46,0	225	33	36,0	29,0	02214820
MF 52 × 1,5	1,5	50,5	190	27	40,0	32,0	02214840
MF 52 × 2	2,0	50,0	190	27	40,0	32,0	02214850
MF 52 × 3	3,0	49,0	225	33	40,0	32,0	02214860
MF 52 × 4	4,0	48,0	225	33	36,0	29,0	02214870

МАШИННЫЙ МЕТЧИК

ТЕХНИЧЕСКАЯ ИНФОРМАЦИЯ



Норма	DIN 374	Вид отверстия	глухое < 3хд
Резьба	MF	Направление	правый
Материал	HSSE-G	Класс точности	6h
Форма	Форма С / RSP 35°	Обр. Материал	Сталь

Машинный метчик с проходным хвостовиком, со спиральной канавкой 35 градусов, 2-3 витка резьбы

							Арт.-Нр.
MF 3 × 0,35	0,35	2,65	56	8	2,2	1,9	02226260
MF 4 × 0,5	0,5	3,5	63	8	2,8	2,1	02226270
MF 5 × 0,5	0,5	4,5	70	8	3,5	2,7	02226280
MF 5 × 0,75	0,75	4,25	70	8	3,5	2,7	02226290
MF 6 × 0,5	0,5	5,5	80	12	4,5	3,4	02226320
MF 6 × 0,75	0,75	5,25	80	12	4,5	3,4	02226330
MF 7 × 0,75	0,75	6,25	80	12	5,5	4,3	02226360
MF 8 × 0,5	0,5	7,5	80	12	6,0	4,9	02226380
MF 8 × 0,75	0,75	7,25	80	12	6,0	4,9	02226390
MF 8 × 1	1,0	7,0	90	16	6,0	4,9	02226400
MF 9 × 1	1,0	8,0	90	16	7,0	5,5	02226440
MF 10 × 0,5	0,5	9,5	90	16	7,0	5,5	02226450
MF 10 × 0,75	0,75	9,25	90	16	7,0	5,5	02226460
MF 10 × 1	1,0	9,0	90	16	7,0	5,5	02226470
MF 10 × 1,25	1,25	8,75	100	16	7,0	5,5	02226480
MF 11 × 0,75	0,75	10,25	90	16	8,0	6,2	02226500
MF 11 × 1	1,0	10,0	90	16	8,0	6,2	02226510
MF 11 × 1,25	1,25	9,75	90	16	8,0	6,2	02226520
MF 12 × 0,5	0,5	11,5	100	16	9,0	7,0	02226530
MF 12 × 0,75	0,75	11,25	100	16	9,0	7,0	02226540

							Арт.-Нр.
MF 12 × 1	1,0	11,0	100	16	9,0	7,0	02226550
MF 12 × 1,25	1,25	10,75	100	16	9,0	7,0	02226560
MF 12 × 1,5	1,5	10,5	100	16	9,0	7,0	02226570
MF 13 × 0,5	0,5	12,5	100	16	11,0	9,0	02226580
MF 13 × 0,75	0,75	12,25	100	16	11,0	9,0	02226590
MF 13 × 1	1,0	12,0	100	16	11,0	9,0	02226600
MF 13 × 1,25	1,25	11,75	100	16	11,0	9,0	02226610
MF 13 × 1,5	1,5	11,5	100	16	11,0	9,0	02226620
MF 14 × 0,5	0,5	13,5	100	16	11,0	9,0	02226630
MF 14 × 0,75	0,75	13,25	100	16	11,0	9,0	02226640
MF 14 × 1	1,0	13,0	100	16	11,0	9,0	02226650
MF 14 × 1,25	1,25	12,75	100	16	11,0	9,0	02226660
MF 14 × 1,5	1,5	12,5	100	16	11,0	9,0	02226670
MF 15 × 0,5	0,5	14,5	100	16	12,0	9,0	02226680
MF 15 × 0,75	0,75	14,25	100	16	12,0	9,0	02226690
MF 15 × 1	1,0	14,0	100	16	12,0	9,0	02226700
MF 15 × 1,25	1,25	13,8	100	16	12,0	9,0	02226710
MF 15 × 1,5	1,5	13,5	100	16	12,0	9,0	02226720
MF 16 × 0,5	0,5	15,5	100	16	12,0	9,0	02226730
MF 16 × 0,75	0,75	15,25	100	16	12,0	9,0	02226740
MF 16 × 1	1,0	15,0	100	16	12,0	9,0	02226750
MF 16 × 1,25	1,25	14,75	100	16	12,0	9,0	02226760
MF 16 × 1,5	1,5	14,5	100	16	12,0	9,0	02226770
MF 17 × 0,75	0,75	16,25	100	16	12,0	9,0	02226780
MF 17 × 1	1,0	16,0	100	16	12,0	9,0	02226790
MF 17 × 1,5	1,5	15,5	100	16	12,0	9,0	02226810
MF 18 × 0,75	0,75	17,25	110	20	14,0	11,0	02226830
MF 18 × 1	1,0	17,0	110	20	14,0	11,0	02226840
MF 18 × 1,25	1,25	16,75	110	20	14,0	11,0	02226850
MF 18 × 1,5	1,5	16,5	110	20	14,0	11,0	02226860
MF 18 × 2	2,0	16,0	125	25	14,0	11,0	02226870
MF 20 × 0,75	0,75	19,25	125	20	16,0	12,0	02226920
MF 20 × 1	1,0	19,0	125	20	16,0	12,0	02226930
MF 20 × 1,25	1,25	18,75	125	20	16,0	12,0	02226940
MF 20 × 1,5	1,5	18,5	125	20	16,0	12,0	02226950
MF 20 × 2	2,0	18,0	140	25	16,0	12,0	02226960
MF 21 × 1	1,0	20,0	125	20	16,0	12,0	02226980
MF 21 × 1,5	1,5	19,5	125	20	16,0	12,0	02228000
MF 22 × 0,75	0,75	21,25	125	20	18,0	14,5	02228020
MF 22 × 1	1,0	21,0	125	20	18,0	14,5	02228030
MF 22 × 1,25	1,25	20,75	125	20	18,0	14,5	02228040
MF 22 × 1,5	1,5	20,5	125	20	18,0	14,5	02228050
MF 22 × 2	2,0	20,0	140	25	18,0	14,5	02228060
MF 23 × 1	1,0	22,0	125	20	18,0	14,5	02228070

							Арт.-Нр.
MF 23 × 1,5	1,5	21,5	125	20	18,0	14,5	02228080
MF 24 × 0,75	0,75	23,25	125	20	18,0	14,5	02228100
MF 24 × 1	1,0	23,0	125	20	18,0	14,5	02228110
MF 24 × 1,25	1,25	22,75	125	20	18,0	14,5	02228120
MF 24 × 1,5	1,5	22,5	140	20	18,0	14,5	02228130
MF 24 × 2	2,0	22,0	140	20	18,0	14,5	02228140
MF 25 × 1	1,0	24,0	140	20	18,0	14,5	02228150
MF 25 × 1,5	1,5	23,5	140	20	18,0	14,5	02228170
MF 25 × 2	2,0	23,0	140	20	18,0	14,5	02228180
MF 26 × 1	1,0	25,0	140	20	18,0	14,5	02228190
MF 26 × 1,5	1,5	24,5	140	20	18,0	14,5	02228210
MF 26 × 2	2,0	24,0	140	20	18,0	14,5	02228220
MF 27 × 1	1,0	26,0	150	20	20,0	16,0	02228230
MF 27 × 1,5	1,5	25,5	140	20	20,0	16,0	02228240
MF 27 × 2	2,0	25,0	140	20	20,0	16,0	02228250
MF 28 × 1	1,0	27,0	150	20	20,0	16,0	02228260
MF 28 × 1,5	1,5	26,5	140	20	20,0	16,0	02228270
MF 28 × 2	2,0	26,0	140	20	20,0	16,0	02228280
MF 30 × 1	1,0	29,0	150	22	22,0	18,0	02228290
MF 30 × 1,5	1,5	28,5	150	22	22,0	18,0	02228300
MF 30 × 2	2,0	28,0	150	22	22,0	18,0	02228310
MF 30 × 3	3,0	27,0	160	35	22,0	18,0	02228320
MF 32 × 1	1,0	31,0	150	22	22,0	18,0	02228330
MF 32 × 1,5	1,5	30,5	150	22	22,0	18,0	02228340
MF 32 × 2	2,0	30,0	160	22	22,0	18,0	02228350
MF 32 × 3	3,0	29,0	160	35	22,0	18,0	02228360
MF 33 × 1	1,0	32,0	150	25	25,0	20,0	02228370
MF 33 × 1,5	1,5	31,5	160	25	25,0	20,0	02228380
MF 33 × 2	2,0	31,0	160	25	25,0	20,0	02228390
MF 33 × 3	3,0	30,0	160	35	25,0	20,0	02228400
MF 34 × 1	1,0	33,0	150	25	28,0	22,0	02228410
MF 34 × 1,5	1,5	32,5	170	28	28,0	22,0	02228420
MF 34 × 2	2,0	32,0	160	32	28,0	22,0	02228430
MF 34 × 3	3,0	31,0	160	36	28,0	22,0	02228440
MF 35 × 1	1,0	34,0	150	25	28,0	22,0	02228450
MF 35 × 1,5	1,5	33,5	170	25	28,0	22,0	02228460
MF 35 × 2	2,0	33,0	160	25	28,0	22,0	02228470
MF 35 × 3	3,0	32,0	160	45	28,0	22,0	02228480
MF 36 × 1	1,0	35,0	170	25	28,0	22,0	02228490
MF 36 × 1,5	1,5	34,5	170	25	28,0	22,0	02228500
MF 36 × 2	2,0	34,0	170	25	28,0	22,0	02228510
MF 36 × 3	3,0	33,0	200	45	28,0	22,0	02228520
MF 38 × 1	1,0	37,0	170	25	28,0	22,0	02228530
MF 38 × 1,5	1,5	36,5	170	25	28,0	22,0	02228540

							Арт.-Нр.
MF 38 × 2	2,0	36,0	180	25	28,0	22,0	02228550
MF 38 × 3	3,0	35,0	190	30	28,0	22,0	02228560
MF 39 × 1,5	1,5	37,5	170	25	32,0	24,0	02228570
MF 39 × 2	2,0	37,0	170	25	32,0	24,0	02228580
MF 39 × 3	3,0	36,0	200	30	32,0	24,0	02228590
MF 40 × 1,5	1,5	38,5	170	25	32,0	24,0	02228610
MF 40 × 2	2,0	38,0	170	25	32,0	24,0	02228620
MF 40 × 3	3,0	37,0	200	30	32,0	24,0	02228630
MF 42 × 1,5	1,5	40,5	180	25	32,0	24,0	02228640
MF 42 × 2	2,0	40,0	180	25	32,0	24,0	02228650
MF 42 × 3	3,0	39,0	200	30	32,0	24,0	02228660
MF 42 × 4	4,0	38,0	225	30	32,0	24,0	02228670
MF 45 × 1,5	1,5	43,5	180	27	36,0	29,0	02228690
MF 45 × 2	2,0	43,0	180	27	36,0	29,0	02228700
MF 45 × 3	3,0	42,0	200	30	36,0	29,0	02228710
MF 45 × 4	4,0	41,0	225	30	36,0	29,0	02228720
MF 48 × 1,5	1,5	46,5	190	27	36,0	29,0	02228740
MF 48 × 2	2,0	46,0	190	27	36,0	29,0	02228750
MF 48 × 3	3,0	45,0	225	33	36,0	29,0	02228760
MF 48 × 4	4,0	44,0	225	33	36,0	29,0	02228770
MF 50 × 1,5	1,5	48,5	190	27	36,0	29,0	02228780
MF 50 × 2	2,0	48,0	190	32	36,0	29,0	02228800
MF 50 × 3	3,0	47,0	225	33	36,0	29,0	02228810
MF 50 × 4	4,0	46,0	225	33	36,0	29,0	02228820
MF 52 × 1,5	1,5	50,5	190	27	40,0	32,0	02228840
MF 52 × 2	2,0	50,0	190	27	40,0	32,0	02228850
MF 52 × 3	3,0	49,0	225	33	40,0	32,0	02228860
MF 52 × 4	4,0	48,0	225	33	36,0	29,0	02228870

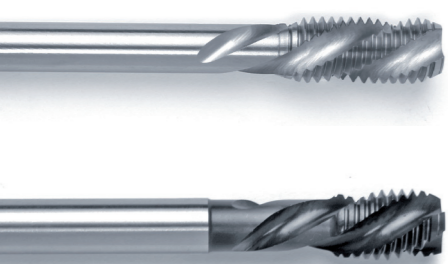

МАШИННЫЙ МЕТЧИК



ТЕХНИЧЕСКАЯ ИНФОРМАЦИЯ

Норма	DIN 374	Вид отверстия	глухое < 3хd
Резьба	MF	Направление	правый
Материал	HSSE-G / VAP	Класс точности	6h
Форма	Форма C / RSP 35°	Обр. Материал	Сталь

Машинный метчик с проходным хвостовиком, со спиральной канавкой 35 градусов, 2-3 витка резьбы, vaporизированный

							Арт.-Нр.
MF 3 × 0,35	0,35	2,65	56	8	2,2	1,9	02216340
MF 4 × 0,5	0,5	3,5	63	8	2,8	2,1	02216350
MF 5 × 0,5	0,5	4,5	70	8	3,5	2,7	02216360
MF 5 × 0,75	0,75	4,25	70	8	3,5	2,7	02216370
MF 6 × 0,5	0,5	5,5	80	12	4,5	3,4	02216380
MF 6 × 0,75	0,75	5,25	80	12	4,5	3,4	02216390
MF 7 × 0,75	0,75	6,25	80	12	5,5	4,3	02216400
MF 8 × 0,5	0,5	7,5	80	12	6,0	4,9	02216410
MF 8 × 0,75	0,75	7,25	80	12	6,0	4,9	02216420
MF 8 × 1	1,0	7,0	90	16	6,0	4,9	02216430
MF 9 × 1	1,0	8,0	90	16	7,0	5,5	02216440
MF 10 × 0,5	0,5	9,5	90	16	7,0	5,5	02216450
MF 10 × 0,75	0,75	9,25	90	16	7,0	5,5	02216460
MF 10 × 1	1,0	9,0	100	16	7,0	5,5	02216470
MF 10 × 1,25	1,25	8,75	100	16	7,0	5,5	02216480
MF 11 × 0,75	0,75	10,25	90	16	8,0	6,2	02216490
MF 11 × 1	1,0	10,0	90	16	8,0	6,2	02216500
MF 11 × 1,25	1,25	9,75	90	16	8,0	6,2	02216510
MF 12 × 0,5	0,5	11,5	100	16	9,0	7,0	02216520
MF 12 × 0,75	0,75	11,25	100	16	9,0	7,0	02216530
MF 12 × 1	1,0	11,0	100	16	9,0	7,0	02216540
MF 12 × 1,25	1,25	10,75	100	16	9,0	7,0	02216550
MF 12 × 1,5	1,5	10,5	100	16	9,0	7,0	02216570
MF 13 × 0,5	0,5	12,5	100	16	11,0	9,0	02216580
MF 13 × 0,75	0,75	12,25	100	16	11,0	9,0	02216590
MF 13 × 1	1,0	12,0	100	16	11,0	9,0	02216600
MF 13 × 1,25	1,25	11,75	100	16	11,0	9,0	02216610
MF 13 × 1,5	1,5	11,5	100	16	11,0	9,0	02216620
MF 14 × 0,5	0,5	13,5	100	16	11,0	9,0	02216630
MF 14 × 0,75	0,75	13,25	100	16	11,0	9,0	02216640
MF 14 × 1	1,0	13,0	100	16	11,0	9,0	02216650
MF 14 × 1,25	1,25	12,75	100	16	11,0	9,0	02216660
MF 14 × 1,5	1,5	12,5	100	16	11,0	9,0	02216670
MF 15 × 0,5	0,5	14,5	100	16	12,0	9,0	02216680
MF 15 × 0,75	0,75	14,25	100	16	12,0	9,0	02216690
MF 15 × 1	1,0	14,0	100	16	12,0	9,0	02216700

							Арт.-Нр.
MF 15 × 1,25	1,25	13,8	100	16	12,0	9,0	02216710
MF 15 × 1,5	1,5	13,5	100	16	12,0	9,0	02216720
MF 16 × 0,5	0,5	15,5	100	16	12,0	9,0	02216730
MF 16 × 0,75	0,75	15,25	100	16	12,0	9,0	02216740
MF 16 × 1	1,0	15,0	100	16	12,0	9,0	02216750
MF 16 × 1,25	1,25	14,75	100	16	12,0	9,0	02216760
MF 16 × 1,5	1,5	14,5	100	16	12,0	9,0	02216770
MF 17 × 0,75	0,75	16,25	100	16	12,0	9,0	02216780
MF 17 × 1	1,0	16,0	100	16	12,0	9,0	02216790
MF 17 × 1,5	1,5	15,5	100	16	12,0	9,0	02216800
MF 18 × 0,75	0,75	17,25	110	20	14,0	11,0	02216810
MF 18 × 1	1,0	17,0	110	20	14,0	11,0	02216820
MF 18 × 1,25	1,25	16,75	110	20	14,0	11,0	02216830
MF 18 × 1,5	1,5	16,5	110	20	14,0	11,0	02216860
MF 18 × 2	2,0	16,0	125	25	14,0	11,0	02216870
MF 20 × 0,75	0,75	19,25	125	20	16,0	12,0	02216880
MF 20 × 1	1,0	19,0	125	20	16,0	12,0	02216890
MF 20 × 1,25	1,25	18,75	125	20	16,0	12,0	02216900
MF 20 × 1,5	1,5	18,5	125	20	16,0	12,0	02216950
MF 20 × 2	2,0	18,0	140	25	16,0	12,0	02216960
MF 21 × 1	1,0	20,0	125	20	16,0	12,0	02216970
MF 21 × 1,5	1,5	19,5	125	20	16,0	12,0	02216980
MF 22 × 0,75	0,75	21,25	125	20	18,0	14,5	02216990
MF 22 × 1	1,0	21,0	125	20	18,0	14,5	02217000
MF 22 × 1,25	1,25	20,75	125	20	18,0	14,5	02217010
MF 22 × 1,5	1,5	20,5	125	20	18,0	14,5	02217020
MF 22 × 2	2,0	20,0	140	25	18,0	14,5	02217030
MF 23 × 1	1,0	22,0	125	20	18,0	14,5	02217040
MF 23 × 1,5	1,5	21,5	125	20	18,0	14,5	02217050
MF 24 × 0,75	0,75	23,25	125	20	18,0	14,5	02217060
MF 24 × 1	1,0	23,0	125	20	18,0	14,5	02217070
MF 24 × 1,25	1,25	22,75	125	20	18,0	14,5	02217080
MF 24 × 1,5	1,5	22,5	140	20	18,0	14,5	02217090
MF 24 × 2	2,0	22,0	140	20	18,0	14,5	02217100

МАШИННЫЙ МЕТЧИК

ТЕХНИЧЕСКАЯ ИНФОРМАЦИЯ



Машинный метчик с проходным хвостовиком, 2-3 витка резьбы

Норма	DIN 374	Вид отверстия	глухое < 1.1/2xd
Резьба	MF	Направление	правый
Материал	HSSE-G	Класс точности	6h
Форма	Форма С	Обр. Материал	Сталь

							Арт.-Нр.
MF 3 × 0,35	0,35	2,65	56	8	2,2	—	02221200
MF 3,5 × 0,35	0,35	3,15	56	8	2,5	2,1	02221220
MF 4 × 0,35	0,35	3,65	63	10	2,8	2,1	02221230
MF 4 × 0,5	0,5	3,5	63	10	2,8	2,7	02221240
MF 4,5 × 0,5	0,5	4,0	70	12	3,5	2,7	02221260
MF 5 × 0,5	0,5	4,5	70	12	3,5	2,7	02221280
MF 5 × 0,75	0,75	4,25	70	12	3,5	2,7	02221290
MF 6 × 0,5	0,5	5,5	80	14	4,5	3,4	02221320
MF 6 × 0,75	0,75	5,25	80	14	4,5	3,4	02221330
MF 7 × 0,5	0,5	6,5	80	14	5,5	4,3	02221350
MF 7 × 0,75	0,75	6,25	80	14	5,5	4,3	02221360
MF 8 × 0,5	0,5	7,5	80	18	6,0	4,9	02221380
MF 8 × 0,75	0,75	7,25	80	18	6,0	4,9	02221390
MF 8 × 1	1,0	7,0	90	22	6,0	4,9	02221400
MF 8 × 1,5	1,5	6,5	90	22	6,0	4,9	02221410
MF 9 × 0,5	0,5	8,5	90	20	7,0	5,5	02221420
MF 9 × 0,75	0,75	8,25	90	20	7,0	5,5	02221430
MF 9 × 1	1,0	8,0	90	22	7,0	5,5	02221440
MF 10 × 0,5	0,5	9,5	90	20	7,0	5,5	02221450
MF 10 × 0,75	0,75	9,25	90	20	7,0	5,5	02221460
MF 10 × 1	1,0	9,0	90	20	7	5,5	02221470
MF 10 × 1,25	1,25	8,75	100	20	7,0	5,5	02221480
MF 11 × 0,5	0,5	10,5	90	20	8,0	6,2	02221490
MF 11 × 0,75	0,75	10,25	90	20	8,0	6,2	02221500
MF 11 × 1	1,0	10,0	90	20	8,0	6,2	02221510
MF 11 × 1,25	1,25	9,75	90	20	8,0	6,2	02221520
MF 12 × 0,5	0,5	11,5	100	22	9,0	7,0	02221530
MF 12 × 0,75	0,75	11,25	100	22	9,0	7,0	02221540
MF 12 × 1	1,0	11,0	100	22	9,0	7,0	02221550
MF 12 × 1,25	1,25	10,75	100	22	9,0	7,0	02221560
MF 12 × 1,5	1,5	10,5	100	22	9,0	7,0	02221570
MF 13 × 0,5	0,5	12,5	100	22	11,0	9,0	02221580
MF 13 × 0,75	0,75	12,25	100	22	11,0	9,0	02221590
MF 13 × 1	1,0	12,0	100	22	11,0	9,0	02221600
MF 13 × 1,25	1,25	11,75	100	22	11,0	9,0	02221610
MF 13 × 1,5	1,5	11,5	100	22	11,0	9,0	02221620

							Арт.-Нр.
MF 14 × 0,5	0,5	13,5	100	22	11,0	9,0	02221630
MF 14 × 0,75	0,75	13,25	100	22	11,0	9,0	02221640
MF 14 × 1	1,0	13,0	100	22	11,0	9,0	02221650
MF 14 × 1,25	1,25	12,75	100	22	11,0	9,0	02221660
MF 14 × 1,5	1,5	12,5	100	22	11,0	9,0	02221670
MF 15 × 0,5	0,5	14,5	100	22	12,0	9,0	02221680
MF 15 × 0,75	0,75	14,25	100	22	12,0	9,0	02221690
MF 15 × 1	1,0	14,0	100	22	12,0	9,0	02221700
MF 15 × 1,25	1,25	13,8	100	22	12,0	9,0	02221710
MF 15 × 1,5	1,5	13,5	100	22	12,0	9,0	02221720
MF 16 × 0,5	0,5	15,5	100	22	12,0	9,0	02221730
MF 16 × 0,75	0,75	15,25	100	22	12,0	9,0	02221740
MF 16 × 1	1,0	15,0	100	22	12,0	9,0	02221750
MF 16 × 1,25	1,25	14,75	100	22	12,0	9,0	02221760
MF 16 × 1,5	1,5	14,5	100	22	12,0	9,0	02221770
MF 17 × 0,75	0,75	16,25	100	22	12,0	9,0	02221780
MF 17 × 1	1,0	16,0	100	22	12,0	9,0	02221790
MF 17 × 1,5	1,5	15,5	100	22	12,0	9,0	02221810
MF 18 × 0,5	0,5	17,5	110	25	14,0	11,0	02221820
MF 18 × 0,75	0,75	17,25	110	25	14,0	11,0	02221830
MF 18 × 1	1,0	17,0	110	25	14,0	11,0	02221840
MF 18 × 1,25	1,25	16,75	110	25	14,0	11,0	02221850
MF 18 × 1,5	1,5	16,5	110	25	14,0	11,0	02221860
MF 18 × 2	2,0	16,0	125	34	14,0	11,0	02221870
MF 19 × 1	1,0	18,0	125	25	14,0	11,0	02221880
MF 19 × 1,5	1,5	17,5	125	25	14,0	11,0	02221890
MF 20 × 0,5	0,5	19,5	125	25	16,0	12,0	02221910
MF 20 × 0,75	0,75	19,25	125	25	16,0	12,0	02221920
MF 20 × 1	1,0	19,0	125	25	16,0	12,0	02221930
MF 20 × 1,25	1,25	18,75	125	25	16,0	12,0	02221940
MF 20 × 1,5	1,5	18,5	125	25	16,0	12,0	02221950
MF 20 × 2	2,0	18,0	140	34	16,0	12,0	02221960
MF 21 × 1	1,0	20,0	125	25	16,0	12,0	02221980
MF 21 × 1,5	1,5	19,5	125	25	16,0	12,0	02222000
MF 22 × 0,5	0,5	21,5	125	20	18,0	14,5	02222010
MF 22 × 0,75	0,75	21,25	125	25	18,0	14,5	02222020
MF 22 × 1	1,0	21,0	125	25	18,0	14,5	02222030
MF 22 × 1,25	1,25	20,75	125	25	18,0	14,5	02222040
MF 22 × 1,5	1,5	20,5	125	25	18,0	14,5	02222050
MF 22 × 2	2,0	20,0	140	34	18,0	14,5	02222060
MF 23 × 1	1,0	22,0	125	28	18,0	14,5	02222070
MF 23 × 1,5	1,5	21,5	125	28	18,0	14,5	02222080
MF 24 × 0,5	0,5	23,5	125	28	18,0	14,5	02222090
MF 24 × 0,75	0,75	23,25	140	28	18,0	14,5	02222100

							Арт.-Нр.
MF 24 × 1	1,0	23,0	140	28	18,0	14,5	02222110
MF 24 × 1,25	1,25	22,75	140	28	18,0	14,5	02222120
MF 24 × 1,5	1,5	22,5	140	28	18,0	14,5	02222130
MF 24 × 2	2,0	22,0	140	28	18,0	14,5	02222140
MF 25 × 1	1,0	24,0	140	28	18,0	14,5	02222150
MF 25 × 1,5	1,5	23,5	140	28	18,0	14,5	02222170
MF 25 × 2	2,0	23,0	140	28	18,0	14,5	02222180
MF 26 × 1	1,0	25,0	140	28	18,0	14,5	02222190
MF 26 × 1,25	1,25	24,75	140	28	18,0	14,5	02222200
MF 26 × 1,5	1,5	24,5	140	28	18,0	14,5	02222210
MF 26 × 2	2,0	24,0	140	28	18,0	14,5	02222220
MF 27 × 1	1,0	26,0	150	28	20,0	16,0	02222230
MF 27 × 1,5	1,5	25,5	140	28	20,0	16,0	02222240
MF 27 × 2	2,0	25,0	150	28	20,0	16,0	02222250
MF 28 × 1	1,0	27,0	150	28	20,0	16,0	02222260
MF 28 × 1,5	1,5	26,5	150	28	20,0	16,0	02222270
MF 28 × 2	2,0	26,0	140	28	20,0	16,0	02222280
MF 30 × 1	1,0	29,0	150	28	22,0	18,0	02222290
MF 30 × 1,5	1,5	28,5	150	28	22,0	18,0	02222300
MF 30 × 2	2,0	28,0	150	28	22,0	18,0	02222310
MF 30 × 3	3,0	27,0	180	45	22,0	18,0	02222320
MF 32 × 1	1,0	31,0	150	30	22,0	18,0	02222330
MF 32 × 1,5	1,5	30,5	150	30	22,0	18,0	02222340
MF 32 × 2	2,0	30,0	150	30	22,0	18,0	02222350
MF 32 × 3	3,0	29,0	180	50	22,0	18,0	02222360
MF 33 × 1	1,0	32,0	150	30	25,0	20,0	02222370
MF 33 × 1,5	1,5	31,5	160	30	25,0	20,0	02222380
MF 33 × 2	2,0	31,0	160	30	25,0	20,0	02222390
MF 33 × 3	3,0	30,0	180	50	25,0	20,0	02222400
MF 34 × 1	1,0	33,0	170	30	28,0	22,0	02222410
MF 34 × 1,5	1,5	32,5	170	30	28,0	22,0	02222420
MF 34 × 2	2,0	32,0	170	30	28,0	22,0	02222430
MF 34 × 3	3,0	31,0	200	56	28,0	22,0	02222440
MF 35 × 1	1,0	34,0	170	30	28,0	22,0	02222450
MF 35 × 1,5	1,5	33,5	170	30	28,0	22,0	02222460
MF 35 × 2	2,0	33,0	170	30	28,0	22,0	02222470
MF 35 × 3	3,0	32,0	200	56	28,0	22,0	02222480
MF 36 × 1	1,0	35,0	170	30	28,0	22,0	02222490
MF 36 × 1,5	1,5	34,5	170	30	28,0	22,0	02222500
MF 36 × 2	2,0	34,0	170	30	28,0	22,0	02222510
MF 36 × 3	3,0	33,0	200	56	28,0	22,0	02222520
MF 38 × 1	1,0	37,0	170	30	28,0	22,0	02222530
MF 38 × 1,5	1,5	36,5	170	30	28,0	22,0	02222540
MF 38 × 2	2,0	36,0	170	30	28,0	22,0	02222550

							Арт.-Нр.
MF 38 × 3	3,0	35,0	200	56	28,0	22,0	02222560
MF 39 × 1,5	1,5	37,5	170	30	32,0	24,0	02222570
MF 39 × 2	2,0	37,0	170	30	32,0	24,0	02222580
MF 39 × 3	3,0	36,0	200	60	32,0	24,0	02222590
MF 40 × 1	1,0	39,0	170	30	32,0	24,0	02222600
MF 40 × 1,5	1,5	38,5	170	30	32,0	24,0	02222610
MF 40 × 2	2,0	38,0	170	30	32,0	24,0	02222620
MF 40 × 3	3,0	37,0	200	60	32,0	24,0	02222630
MF 42 × 1,5	1,5	40,5	170	30	32,0	24,0	02222640
MF 42 × 2	2,0	40,0	170	30	32,0	24,0	02222650
MF 42 × 3	3,0	39,0	200	60	32,0	24,0	02222660
MF 42 × 4	4,0	38,0	225	60	32,0	24,0	02222670
MF 45 × 1	1,0	44,0	180	32	36,0	29,0	02222680
MF 45 × 1,5	1,5	43,5	180	32	36,0	29,0	02222690
MF 45 × 2	2,0	43,0	180	32	36,0	29,0	02222700
MF 45 × 3	3,0	42,0	200	50	36,0	29,0	02222710
MF 45 × 4	4,0	41,0	225	65	36,0	29,0	02222720
MF 48 × 1	1,0	47,0	190	32	36,0	29,0	02222730
MF 48 × 1,5	1,5	46,5	190	32	36,0	29,0	02222740
MF 48 × 2	2,0	46,0	190	32	36,0	29,0	02222750
MF 48 × 3	3,0	45,0	225	50	36,0	29,0	02222760
MF 48 × 4	4,0	44,0	225	70	36,0	29,0	02222770
MF 50 × 1	1,0	49,0	190	32	36,0	29,0	02222780
MF 50 × 1,5	1,5	48,5	190	32	36,0	29,0	02222790
MF 50 × 2	2,0	48,0	190	32	36,0	29,0	02222800
MF 50 × 3	3,0	47,0	225	50	36,0	29,0	02222810
MF 50 × 4	4,0	46,0	225	70	36,0	29,0	02222820
MF 52 × 1	1,0	51,0	190	32	40,0	32,0	02222830
MF 52 × 1,5	1,5	50,5	190	32	40,0	32,0	02222840
MF 52 × 2	2,0	50,0	190	32	40,0	32,0	02222850
MF 52 × 3	3,0	49,0	225	50	40,0	32,0	02222860
MF 52 × 4	4,0	48,0	225	70	36,0	29,0	02222870

МАШИННЫЙ МЕТЧИК



Машинный метчик с проходным хвостовиком, 2-3 витка резьбы, вальцованный

ТЕХНИЧЕСКАЯ ИНФОРМАЦИЯ

Норма	DIN 374	Вид отверстия	глухое < 1.1/2xd
Резьба	MF	Направление	правый
Материал	HSSE-G / VAP	Класс точности	6h
Форма	Форма С	Обр. Материал	Сталь

							Арт.-Нр.
MF 3 × 0,35	0,35	2,65	56	8	2,2	—	02217250
MF 3,5 × 0,35	0,35	3,15	56	8	2,5	2,1	02217260
MF 4 × 0,35	0,35	3,65	63	10	2,8	2,1	02217270
MF 4 × 0,5	0,5	3,5	63	10	2,8	2,7	02217280
MF 4,5 × 0,5	0,5	4,0	70	12	3,5	2,7	02217290
MF 5 × 0,5	0,5	4,5	70	12	3,5	2,7	02217300
MF 5 × 0,75	0,75	4,25	70	12	3,5	2,7	02217310
MF 6 × 0,5	0,5	5,5	80	14	4,5	3,4	02217320
MF 6 × 0,75	0,75	5,25	80	14	4,5	3,4	02217330
MF 7 × 0,5	0,5	6,5	80	14	5,5	4,3	02217340
MF 7 × 0,75	0,75	6,25	80	14	5,5	4,3	02217350
MF 8 × 0,5	0,5	7,5	80	18	6,0	4,9	02217360
MF 8 × 0,75	0,75	7,25	80	18	6,0	4,9	02217390
MF 8 × 1	1,0	7,0	90	22	6,0	4,9	02217400
MF 8 × 1,5	1,5	6,5	90	22	6,0	4,9	02217410
MF 9 × 0,5	0,5	8,5	90	20	7,0	5,5	02217420
MF 9 × 0,75	0,75	8,25	90	20	7,0	5,5	02217430
MF 9 × 1	1,0	8,0	90	22	7,0	5,5	02217440
MF 10 × 0,5	0,5	9,5	90	20	7,0	5,5	02217450
MF 10 × 0,75	0,75	9,25	90	20	7,0	5,5	02217460
MF 10 × 1	1,0	9,0	90	20	7	5,5	02217470
MF 10 × 1,25	1,25	8,75	100	20	7,0	5,5	02217480
MF 11 × 0,5	0,5	10,5	90	20	8,0	6,2	02217490
MF 11 × 0,75	0,75	10,25	90	20	8,0	6,2	02217500
MF 11 × 1	1,0	10,0	90	20	8,0	6,2	02217510
MF 11 × 1,25	1,25	9,75	90	20	8,0	6,2	02217520
MF 12 × 0,5	0,5	11,5	100	22	9,0	7,0	02217530
MF 12 × 0,75	0,75	11,25	100	22	9,0	7,0	02217540
MF 12 × 1	1,0	11,0	100	22	9,0	7,0	02217550
MF 12 × 1,25	1,25	10,75	100	22	9,0	7,0	02217560
MF 12 × 1,5	1,5	10,5	100	22	9,0	7,0	02217570
MF 13 × 0,5	0,5	12,5	100	22	11,0	9,0	02217580
MF 13 × 0,75	0,75	12,25	100	22	11,0	9,0	02217590
MF 13 × 1	1,0	12,0	100	22	11,0	9,0	02217600
MF 13 × 1,25	1,25	11,75	100	22	11,0	9,0	02217610
MF 13 × 1,5	1,5	11,5	100	22	11,0	9,0	02217620

							Арт.-Нр.
MF 14 × 0,5	0,5	13,5	100	22	11,0	9,0	02217630
MF 14 × 0,75	0,75	13,25	100	22	11,0	9,0	02217640
MF 14 × 1	1,0	13,0	100	22	11,0	9,0	02217650
MF 14 × 1,25	1,25	12,75	100	22	11,0	9,0	02217660
MF 14 × 1,5	1,5	12,5	100	22	11,0	9,0	02217670
MF 15 × 0,5	0,5	14,5	100	22	12,0	9,0	02217680
MF 15 × 0,75	0,75	14,25	100	22	12,0	9,0	02217690
MF 15 × 1	1,0	14,0	100	22	12,0	9,0	02217700
MF 15 × 1,25	1,25	13,8	100	22	12,0	9,0	02217710
MF 15 × 1,5	1,5	13,5	100	22	12,0	9,0	02217720
MF 16 × 0,5	0,5	15,5	100	22	12,0	9,0	02217730
MF 16 × 0,75	0,75	15,25	100	22	12,0	9,0	02217740
MF 16 × 1	1,0	15,0	100	22	12,0	9,0	02217750
MF 16 × 1,25	1,25	14,75	100	22	12,0	9,0	02217760
MF 16 × 1,5	1,5	14,5	100	22	12,0	9,0	02217770
MF 17 × 0,75	0,75	16,25	100	22	12,0	9,0	02217780
MF 17 × 1	1,0	16,0	100	22	12,0	9,0	02217790
MF 17 × 1,5	1,5	15,5	100	22	12,0	9,0	02217800
MF 18 × 0,5	0,5	17,5	110	25	14,0	11,0	02217810
MF 18 × 0,75	0,75	17,25	110	25	14,0	11,0	02217820
MF 18 × 1	1,0	17,0	110	25	14,0	11,0	02217830
MF 18 × 1,25	1,25	16,75	110	25	14,0	11,0	02217840
MF 18 × 1,5	1,5	16,5	110	25	14,0	11,0	02217860
MF 18 × 2	2,0	16,0	125	34	14,0	11,0	02217870
MF 19 × 1	1,0	18,0	125	25	14,0	11,0	02217880
MF 19 × 1,5	1,5	17,5	125	25	14,0	11,0	02217890
MF 20 × 0,5	0,5	19,5	125	25	16,0	12,0	02217900
MF 20 × 0,75	0,75	19,25	125	25	16,0	12,0	02217910
MF 20 × 1	1,0	19,0	125	25	16,0	12,0	02217920
MF 20 × 1,25	1,25	18,75	125	25	16,0	12,0	02217930
MF 20 × 1,5	1,5	18,5	125	25	16,0	12,0	02217950
MF 20 × 2	2,0	18,0	140	34	16,0	12,0	02217960
MF 21 × 1	1,0	20,0	125	25	16,0	12,0	02217970
MF 21 × 1,5	1,5	19,5	125	25	16,0	12,0	02217980
MF 22 × 0,5	0,5	21,5	125	20	18,0	14,5	02217990
MF 22 × 0,75	0,75	21,25	125	25	18,0	14,5	02219020
MF 22 × 1	1,0	21,0	125	25	18,0	14,5	02219030
MF 22 × 1,25	1,25	20,75	125	25	18,0	14,5	02219040
MF 22 × 1,5	1,5	20,5	125	25	18,0	14,5	02219050
MF 22 × 2	2,0	20,0	140	34	18,0	14,5	02219060
MF 23 × 1	1,0	22,0	125	28	18,0	14,5	02219070
MF 23 × 1,5	1,5	21,5	125	28	18,0	14,5	02219080
MF 24 × 0,5	0,5	23,5	125	28	18,0	14,5	02219090
MF 24 × 0,75	0,75	23,25	140	28	18,0	14,5	02219100

							Арт.-Нр.
MF 24 × 1	1,0	23,0	140	28	18,0	14,5	02219110
MF 24 × 1,25	1,25	22,75	140	28	18,0	14,5	02219120
MF 24 × 1,5	1,5	22,5	140	28	18,0	14,5	02219130
MF 24 × 2	2,0	22,0	140	28	18,0	14,5	02219140

МАШИННЫЙ МЕТЧИК

ТЕХНИЧЕСКАЯ ИНФОРМАЦИЯ



Норма	DIN 2184-1	Вид отверстия	сквозное < 1.1/2хd
Резьба	BSW	Направление	правый
Материал	HSSE-G	Класс точности	6h
Форма	Форма В	Обр. Материал	Сталь

Машинный метчик mit ≤ 3/8 с утолщённым хвостовиком, 4–5 витков резьбы, с прямой канавкой

							Арт.-Нр.
BSW 1/8	40	2,6	56	12	3,5	2,7	01304030
BSW 5/32	32	3,2	63	14	4,5	3,4	01304040
BSW 3/16	24	3,8	70	14	5,5	4,3	01304050
BSW 7/32	24	4,6	80	18	6,0	4,9	01304060
BSW 1/4	20	5,1	80	22	7,0	5,5	01304070
BSW 5/16	18	6,5	90	22	8,0	6,2	01304080
BSW 3/8	16	7,9	100	25	9,0	7,0	01304090
BSW 7/16	14	9,3	100	30	8,0	6,2	01304100
BSW 1/2	12	10,5	110	30	9,0	7,0	01304110
BSW 9/16	12	12,0	110	32	11,0	9,0	01304120
BSW 5/8	11	13,5	110	32	12,0	9,0	01304130
BSW 3/4	10	16,5	125	40	14,0	11,0	01304140
BSW 7/8	9	19,5	140	40	18,0	14,5	01304150
BSW 1	8	22,0	160	50	20,0	16,0	01304160
BSW 1.1/8	7	25,0	180	56	22,0	18,0	01304170
BSW 1.1/4	7	28,0	180	56	25,0	20,0	01304180
BSW 1.3/8	6	30,5	200	63	28,0	22,0	01304190
BSW 1.1/2	6	33,5	200	63	32,0	24,0	01304200
BSW 1.5/8	5	35,5	200	70	32,0	24,0	01304210
BSW 1.3/4	5	39,0	220	70	36,0	29,0	01304220
BSW 1.7/8	4,5	41,5	220	80	36,0	29,0	01304230
BSW 2	4,5	44,5	250	80	40,0	32,0	01304240

МАШИННЫЙ МЕТЧИК



ТЕХНИЧЕСКАЯ ИНФОРМАЦИЯ

Норма	DIN 2184-1	Вид отверстия	глухое < 3xd
Резьба	BSW	Направление	правый
Материал	HSSE-G	Класс точности	6h
Форма	Форма C / RSP 35°	Обр. Материал	Сталь

Машинный метчик mit ≤ 3/8 с утолщённым хвостовиком, со спиральной канавкой 35 градусов, 2-3 витка резьбы

							Арт.-Нр.
BSW 1/8	40	2,6	56	11	3,5	2,7	01315030
BSW 5/32	32	3,2	63	13	4,5	3,4	01315040
BSW 3/16	24	3,8	70	14	5,5	4,3	01315050
BSW 7/32	24	4,6	80	16	6,0	4,9	01315060
BSW 1/4	20	5,1	80	16	7,0	5,5	01315070
BSW 5/16	18	6,5	90	18	8,0	6,2	01315080
BSW 3/8	16	7,9	100	20	9,0	7,0	01315090
BSW 7/16	14	9,3	100	22	8,0	6,2	01315100
BSW 1/2	12	10,5	110	25	9,0	7,0	01315110
BSW 9/16	12	12,0	110	25	11,0	9,0	01315120
BSW 5/8	11	13,5	110	28	12,0	9,0	01315130
BSW 3/4	10	16,5	125	32	14,0	11,0	01315140
BSW 7/8	9	19,5	140	32	18,0	14,5	01315150
BSW 1	8	22,0	160	36	20,0	16,0	01315160
BSW 1.1/8	7	25,0	180	40	22,0	18,0	01315170
BSW 1.1/4	7	28,0	180	40	25,0	20,0	01315180
BSW 1.3/8	6	30,5	200	45	28,0	22,0	01315190
BSW 1.1/2	6	33,5	200	45	32,0	24,0	01315200
BSW 1.5/8	5	35,5	200	56	32,0	24,0	01315210
BSW 1.3/4	5	39,0	220	63	36,0	29,0	01315220
BSW 1.7/8	4,5	41,5	220	63	36,0	29,0	01315230
BSW 2	4,5	44,5	250	70	40,0	32,0	01315240

МАШИННЫЙ МЕТЧИК



ТЕХНИЧЕСКАЯ ИНФОРМАЦИЯ

Норма	DIN 2184-1	Вид отверстия	глухое < 1.1/2xd
Резьба	BSW	Направление	правый
Материал	HSSE-G	Класс точности	6h
Форма	Форма C	Обр. Материал	Сталь

Машинный метчик mit ≤ 3/8 с утолщённым хвостовиком, 2-3 витка резьбы, с прямой канавкой

							Арт.-Нр.
BSW 3/32	48	1,9	50	11	2,8	2,1	01321010
BSW 1/8	40	2,6	56	12	3,5	2,7	01321030
BSW 5/32	32	3,2	63	14	4,5	3,4	01321040
BSW 3/16	24	3,8	70	14	5,5	4,3	01321050
BSW 7/32	24	4,6	80	18	6,0	4,9	01321060
BSW 1/4	20	5,1	80	22	7,0	5,5	01321070
BSW 5/16	18	6,5	90	22	8,0	6,2	01321080
BSW 3/8	16	7,9	100	25	9,0	7,0	01321090
BSW 7/16	14	9,3	100	30	8,0	6,2	01321100
BSW 1/2	12	10,5	110	30	9,0	7,0	01321110
BSW 9/16	12	12,0	110	32	11,0	9,0	01321120
BSW 5/8	11	13,5	110	32	12,0	9,0	01321130
BSW 3/4	10	16,5	125	40	14,0	11,0	01321140
BSW 7/8	9	19,5	140	40	18,0	14,5	01321150
BSW 1	8	22,0	160	50	20,0	16,0	01321160
BSW 1.1/8	7	25,0	180	56	22,0	18,0	01321170
BSW 1.1/4	7	28,0	180	56	25,0	20,0	01321180
BSW 1.3/8	6	30,5	200	63	28,0	22,0	01321190
BSW 1.1/2	6	33,5	200	63	32,0	24,0	01321200
BSW 1.5/8	5	35,5	200	70	32,0	24,0	01321210
BSW 1.3/4	5	39,0	220	70	36,0	29,0	01321220
BSW 1.7/8	4,5	41,5	220	80	36,0	29,0	01321230
BSW 2	4,5	44,5	250	80	40,0	32,0	01321240

МАШИННЫЙ МЕТЧИК



ТЕХНИЧЕСКАЯ ИНФОРМАЦИЯ

Норма	DIN 5156	Вид отверстия	сквозное >1.1/2хd
Резьба	BSP	Направление	правый
Материал	HSSE-G	Класс точности	6h
Форма	Форма В	Обр. Материал	Сталь

Машинный метчик с проходным хвостовиком, 4–5 витков резьбы, с прямой канавкой, со спиральной подточкой (стружколом)

Сечение	М	Н	М	Н	М	Н	М	Н	Арт.-Нр.
BSP 1/8	28	8,8	100	16	7,0	5,5			02504020
BSP 1/4	19	11,8	100	22	11,0	9,0			02504060
BSP 3/8	19	15,3	100	22	12,0	9,0			02504080
BSP 1/2	14	19,0	125	25	16,0	12,0			02504100
BSP 5/8	14	21,0	125	25	18,0	14,5			02504120
BSP 3/4	14	24,5	140	28	20,0	16,0			02504130
BSP 7/8	14	28,3	150	28	22,0	18,0			02504140
BSP 1	11	30,5	160	32	25,0	20,0			02504150
BSP 1.1/8	11	35,5	170	30	28,0	22,0			02504160
BSP 1.1/4	11	39,5	170	30	32,0	24,0			02504180
BSP 1.3/8	11	42,0	190	32	36,0	29,0			02504190
BSP 1.1/2	11	45,0	190	32	36,0	29,0			02504200
BSP 1.5/8	11	49,6	200	40	36,0	29,0			02504210
BSP 1.3/4	11	51,0	200	40	40,0	32,0			02504220
BSP 2	11	57,0	220	40	45,0	35,0			02504230

МАШИННЫЙ МЕТЧИК



ТЕХНИЧЕСКАЯ ИНФОРМАЦИЯ

Норма	DIN 5156	Вид отверстия	глухое > 3хd
Резьба	BSP	Направление	правый
Материал	HSSE-G	Класс точности	6h
Форма	Форма С / RSP 35°	Обр. Материал	Сталь

Машинный метчик с проходным хвостовиком, со спиральной канавкой 35 градусов, 2-3 витка резьбы

Сечение	М	Н	М	Н	М	Н	М	Н	Арт.-Нр.
BSP 1/8	28	8,8	90	12	7,0	5,5			02516020
BSP 1/4	19	11,8	100	16	11,0	9,0			02516060
BSP 3/8	19	15,3	100	18	12,0	9,0			02516080
BSP 1/2	14	19,0	125	25	16,0	12,0			02516100
BSP 5/8	14	21,0	125	25	18,0	14,5			02516120
BSP 3/4	14	24,5	140	28	20,0	16,0			02516130
BSP 7/8	14	28,3	150	28	22,0	18,0			02516140
BSP 1	11	30,5	160	30	25,0	20,0			02516150
BSP 1.1/8	11	35,5	170	30	28,0	22,0			02516170
BSP 1.1/4	11	39,5	170	30	32,0	24,0			02516180
BSP 1.3/8	11	42,0	190	32	36,0	29,0			02516190
BSP 1.1/2	11	45,0	190	32	36,0	29,0			02516200
BSP 1.5/8	11	49,6	200	40	36,0	29,0			02516210
BSP 1.3/4	11	51,0	200	40	40,0	32,0			02516220
BSP 2	11	57,0	220	40	45,0	35,0			02516230

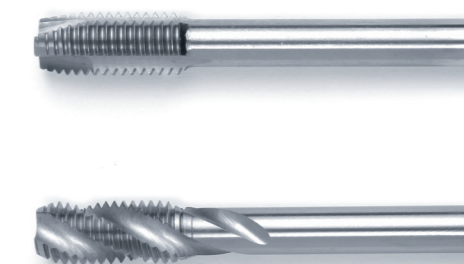

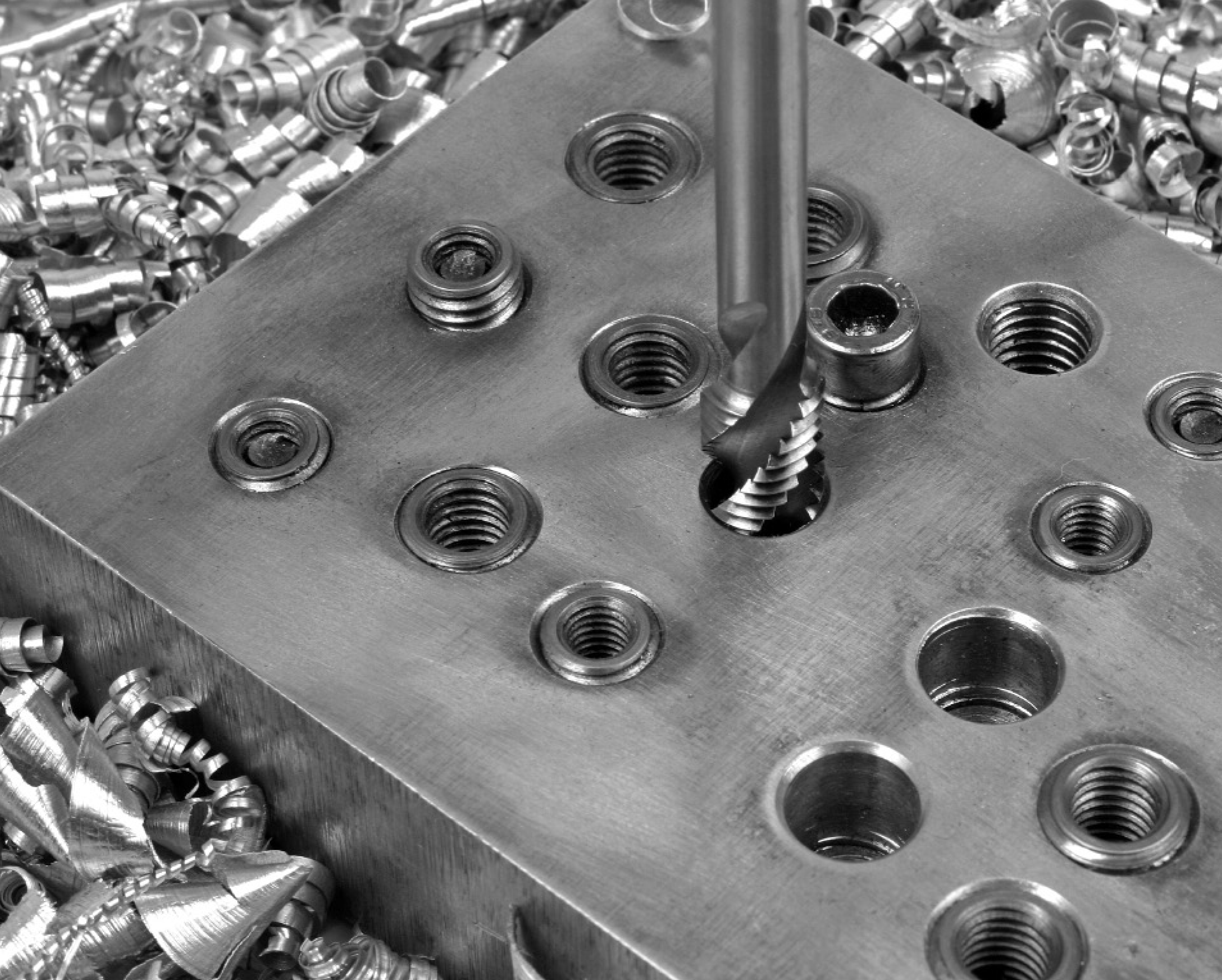

МАШИННЫЙ МЕТЧИК



ТЕХНИЧЕСКАЯ ИНФОРМАЦИЯ

Норма	DIN 5156	Вид отверстия	глухое > 3xd
Резьба	BSP	Направление	правый
Материал	HSSE-G / VAP	Класс точности	6h
Форма	Форма С / RSP 35°	Обр. Материал	VA-Сталь

Машинный метчик с проходным хвостовиком, со спиральной канавкой 35 градусов, 2-3 витка резьбы, вапоризированный

Иконка	М	М	М	М	М	М	Арт.-Нр.
BSP 1/8	28	8,8	90	12	7,0	5,5	02515020
BSP 1/4	19	11,8	100	16	11,0	9,0	02515060
BSP 3/8	19	15,3	100	18	12,0	9,0	02515080
BSP 1/2	14	19,0	125	25	16,0	12,0	02515100
BSP 5/8	14	21,0	125	25	18,0	14,5	02515110
BSP 3/4	14	24,5	140	28	20,0	16,0	02515130
BSP 7/8	14	28,3	150	28	22,0	18,0	02515140
BSP 1	11	30,5	160	30	25,0	20,0	02515150
BSP 1.1/8	11	35,5	170	30	28,0	22,0	02515160
BSP 1.1/4	11	39,5	170	30	32,0	24,0	02515170
BSP 1.3/8	11	42,0	190	32	36,0	29,0	02515180
BSP 1.1/2	11	45,0	190	32	36,0	29,0	02515200
BSP 1.5/8	11	49,6	200	40	36,0	29,0	02515210
BSP 1.3/4	11	51,0	200	40	40,0	32,0	02515220
BSP 2	11	57,0	220	40	45,0	35,0	02515230

МАШИННЫЙ МЕТЧИК



ТЕХНИЧЕСКАЯ ИНФОРМАЦИЯ

Норма	DIN 5156	Вид отверстия	глухое < 1.1/2xd
Резьба	BSP	Направление	правый
Материал	HSSE-G	Класс точности	6h
Форма	Форма С	Обр. Материал	Сталь

Машинный метчик с проходным хвостовиком, с прямой канавкой, 2-3 витка резьбы

Иконка	М	М	М	М	М	М	Арт.-Нр.
BSP 1/8	28	8,8	90	20	7,0	5,5	02521020
BSP 1/4	19	11,8	100	22	11,0	9,0	02521060
BSP 3/8	19	15,3	100	22	12,0	9,0	02521080
BSP 1/2	14	19,0	125	25	16,0	12,0	02521100
BSP 5/8	14	21,0	125	25	18,0	14,5	02521120
BSP 3/4	14	24,5	140	28	20,0	16,0	02521130
BSP 7/8	14	28,3	150	28	22,0	18,0	02521140
BSP 1	11	30,5	160	30	25,0	20,0	02521150
BSP 1.1/8	11	35,5	170	30	28,0	22,0	02521170
BSP 1.1/4	11	39,5	170	30	32,0	24,0	02521180
BSP 1.3/8	11	42,0	190	32	36,0	29,0	02521190
BSP 1.1/2	11	45,0	190	32	36,0	29,0	02521200
BSP 1.3/4	11	51,0	200	40	40,0	32,0	02521220
BSP 2	11	57,0	220	40	45,0	35,0	02521230

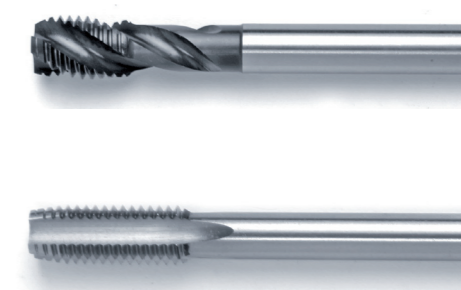

МАШИННЫЙ МЕТЧИК



ТЕХНИЧЕСКАЯ ИНФОРМАЦИЯ

Норма	DIN 5156	Вид отверстия	глухое < 1.1/2xd
Резьба	BSP	Направление	правый
Материал	HSSE-G / VAP	Класс точности	6h
Форма	Форма С	Обр. Материал	VA-Сталь

Машинный метчик с проходным хвостовиком, 2-3 витка резьбы, вapoизированный

							Арт.-Нр.
BSP 1/8	28	8,8	90	20	7,0	5,5	02517020
BSP 1/4	19	11,8	100	22	11,0	9,0	02517060
BSP 3/8	19	15,3	100	22	12,0	9,0	02517080
BSP 1/2	14	19,0	125	25	16,0	12,0	02517100
BSP 5/8	14	21,0	125	25	18,0	14,5	02517120
BSP 3/4	14	24,5	140	28	20,0	16,0	02517130
BSP 7/8	14	28,3	150	28	22,0	18,0	02517140
BSP 1	11	30,5	160	30	25,0	20,0	02517150
BSP 1.1/8	11	35,5	170	30	28,0	22,0	02517170
BSP 1.1/4	11	39,5	170	30	32,0	24,0	02517180
BSP 1.3/8	11	42,0	190	32	36,0	29,0	02517190
BSP 1.1/2	11	45,0	190	32	36,0	29,0	02517200
BSP 1.3/4	11	51,0	200	40	40,0	32,0	02517220
BSP 2	11	57,0	220	40	45,0	35,0	02517230

МАШИННЫЙ МЕТЧИК



ТЕХНИЧЕСКАЯ ИНФОРМАЦИЯ

Норма	DIN 2184-1	Вид отверстия	сквозное < 1.1/2xd
Резьба	UNC	Направление	правый
Материал	HSSE-G	Класс точности	6h
Форма	Форма В	Обр. Материал	Сталь

Машинный метчик ≤ 3/8 с утолщённым хвостовиком, 4-5 витков резьбы, с прямой канавкой, со спиральной подточкой (стружколом)

							Арт.-Нр.
UNC Nr. 2	56	1,8	45	9	2,8	2,1	01604020
UNC Nr. 3	48	2,1	50	9	2,8	2,1	01604030
UNC Nr. 4	40	2,3	56	11	3,5	2,7	01604040
UNC Nr. 5	40	2,6	56	11	3,5	2,7	01604050
UNC Nr. 6	32	2,9	56	12	4,0	3,0	01604060
UNC Nr. 8	32	3,5	63	13	4,5	3,4	01604080
UNC Nr. 10	24	3,9	70	15	6,0	4,9	01604100
UNC Nr. 12	24	4,5	80	16	6,0	4,9	01604120
UNC 1/4	20	5,2	80	17	7,0	5,5	01604130
UNC 5/16	18	6,6	90	22	8	6,2	01604140
UNC 3/8	16	8	100	24	10	8	01604150
UNC 7/16	14	9,4	100	22	8,0	6,2	01604160
UNC 1/2	13	10,8	110	24	9,0	7,0	01604170
UNC 9/16	12	12,3	110	26	11,0	9,0	01604180
UNC 5/8	11	13,5	110	27	12,0	9,0	01604190
UNC 3/4	10	16,5	125	30	14,0	11,0	01604210
UNC 7/8	9	19,5	140	32	18,0	14,5	01604230
UNC 1	8	22,3	160	36	20,0	16,0	01604250
UNC 1.1/8	7	25,0	180	40	22,0	18,0	01604260
UNC 1.1/4	7	28,3	180	40	22,0	18,0	01604270
UNC 1.3/8	6	30,8	200	45	28,0	22,0	01604280
UNC 1.1/2	6	34,0	200	45	32,0	24,0	01604290
UNC 1.5/8	6	37,1	200	56	32,0	24,0	01604300
UNC 1.3/4	5	39,5	220	63	36,0	29,0	01604310
UNC 1.7/8	4,5	42,0	220	63	36,0	29,0	01604320
UNC 2	4,5	45,0	250	70	40,0	32,0	01604330
UNC 2.1/4	4,5	51,5	280	75	45	35	01604340
UNC 2.1/2	4	57,2	315	80	50	39	01604350
UNC 2.3/4	4	63,25	340	80	50	39	01604360
UNC 3	4	69,85	360	85	50	39	01604370

МАШИННЫЙ МЕТЧИК

ТЕХНИЧЕСКАЯ ИНФОРМАЦИЯ



Норма	DIN 2184-1	Вид отверстия	сквозное <1.1/2хd
Резьба	UNC	Направление	правый
Материал	HSSE-G / VAP	Класс точности	6h
Форма	Форма В	Обр. Материал	VA-Сталь

Машинный метчик ≤ 3/8 с утолщённым хвостовиком, 4–5 витков резьбы, со спиральной подточкой (стружколом), вапоризированный

Сечение	М	М	М	М	М	М	Арт.-Нр.
UNC Nr. 2	56	1,8	45	9	2,8	2,1	01605020
UNC Nr. 3	48	2,1	50	9	2,8	2,1	01605030
UNC Nr. 4	40	2,3	56	11	3,5	2,7	01605040
UNC Nr. 5	40	2,6	56	11	3,5	2,7	01605050
UNC Nr. 6	32	2,9	56	12	4,0	3,0	01605060
UNC Nr. 8	32	3,5	63	13	4,5	3,4	01605080
UNC Nr. 10	24	3,9	70	15	6,0	4,9	01605100
UNC Nr. 12	24	4,5	80	16	6,0	4,9	01605120
UNC 1/4	20	5,2	80	17	7,0	5,5	01605130
UNC 5/16	18	6,6	90	22	8	6,2	01605140
UNC 3/8	16	8	100	24	10	8	01605150
UNC 7/16	14	9,4	100	22	8,0	6,2	01605160
UNC 1/2	13	10,8	110	24	9,0	7,0	01605170
UNC 9/16	12	12,3	110	26	11,0	9,0	01605180
UNC 5/8	11	13,5	110	27	12,0	9,0	01605190
UNC 3/4	10	16,5	125	30	14,0	11,0	01605210
UNC 7/8	9	19,5	140	32	18,0	14,5	01605230
UNC 1	8	22,3	160	36	20,0	16,0	01605250
UNC 1.1/8	7	25,0	180	40	22,0	18,0	01605260
UNC 1.1/4	7	28,3	180	40	22,0	18,0	01605270
UNC 1.3/8	6	30,8	200	45	28,0	22,0	01605280
UNC 1.1/2	6	34,0	200	45	32,0	24,0	01605290
UNC 1.5/8	6	37,1	200	56	32,0	24,0	01605300
UNC 1.3/4	5	39,5	220	63	36,0	29,0	01605310
UNC 1.7/8	4,5	42,0	220	63	36,0	29,0	01605320
UNC 2	4,5	45,0	250	70	40,0	32,0	01605330
UNC 2.1/4	4,5	51,5	280	75	45	35	01605340
UNC 2.1/2	4	57,2	315	80	50	39	01605350
UNC 2.3/4	4	63,25	340	80	50	39	01605360
UNC 3	4	69,85	360	85	50	39	01605370

МАШИННЫЙ МЕТЧИК

ТЕХНИЧЕСКАЯ ИНФОРМАЦИЯ



Норма	DIN 2184-1	Вид отверстия	глухое < 3хd
Резьба	UNC	Направление	правый
Материал	HSSE-G	Класс точности	6h
Форма	Форма С / RSP 35°	Обр. Материал	Сталь

Машинный метчик ≤ 3/8 с утолщённым хвостовиком, 2-3 витка резьбы, со спиральной канавкой 35 градусов

Сечение	М	М	М	М	М	М	Арт.-Нр.
UNC Nr. 2	56	1,8	45	5	2,8	2,1	01615020
UNC Nr. 3	48	2,1	50	5	2,8	2,1	01615030
UNC Nr. 4	40	2,3	56	5	3,5	2,7	01615040
UNC Nr. 5	40	2,6	56	5	3,5	2,7	01615050
UNC Nr. 6	32	2,9	56	6	4,0	3,0	01615060
UNC Nr. 8	32	3,5	63	7	4,5	3,4	01615080
UNC Nr. 10	24	3,9	70	9	6,0	4,9	01615100
UNC Nr. 12	24	4,5	80	9	6,0	4,9	01615120
UNC 1/4	20	5,2	80	10	7,0	5,5	01615130
UNC 5/16	18	6,6	90	12	8,0	6,2	01615140
UNC 3/8	16	8,0	100	14	9,0	7,0	01615150
UNC 7/16	14	9,4	100	16	8,0	6,2	01615160
UNC 1/2	13	10,8	110	18	9,0	7,0	01615170
UNC 9/16	12	12,3	110	18	11,0	9,0	01615180
UNC 5/8	11	13,5	110	20	12,0	9,0	01615190
UNC 3/4	10	16,5	125	25	14,0	11,0	01615210
UNC 7/8	9	19,5	140	28	18,0	14,5	01615230
UNC 1	8	22,3	160	32	20,0	16,0	01615250
UNC 1.1/8	7	25,0	180	36	22,0	18,0	01615260
UNC 1.1/4	7	28,3	180	36	22,0	18,0	01615270
UNC 1.3/8	6	30,8	200	40	28,0	22,0	01615280
UNC 1.1/2	6	34,0	200	45	32,0	24,0	01615290
UNC 1.5/8	6	37,1	200	45	32,0	24,0	01615300
UNC 1.3/4	5	39,5	220	52	36,0	29,0	01615310
UNC 1.7/8	4,5	42,0	220	52	36,0	29,0	01615320
UNC 2	4,5	45,0	250	60	40,0	32,0	01615330
UNC 2.1/4	4,5	51,5	280	75	45	35	01615340
UNC 2.1/2	4	57,2	315	80	50	39	01615350
UNC 2.3/4	4	63,25	340	80	50	39	01615360
UNC 3	4	69,85	360	85	50	39	01615370

МАШИННЫЙ МЕТЧИК

ТЕХНИЧЕСКАЯ ИНФОРМАЦИЯ



Норма	DIN 2184-1	Вид отверстия	глухое < 3xd
Резьба	UNC	Направление	правый
Материал	HSSE-G / VAP	Класс точности	6h
Форма	Форма С / RSP 35°	Обр. Материал	VA-Сталь

Машинный метчик ≤ 3/8 с утолщённым хвостовиком, 2-3 витка резьбы, со спиральной канавкой 35 градусов, вапоризированный

Иконка	М	М	М	М	М	М	Арт.-Нр.
UNC Nr. 2	56	1,8	45	5	2,8	2,1	01616020
UNC Nr. 3	48	2,1	50	5	2,8	2,1	01616030
UNC Nr. 4	40	2,3	56	5	3,5	2,7	01616040
UNC Nr. 5	40	2,6	56	5	3,5	2,7	01616050
UNC Nr. 6	32	2,9	56	6	4,0	3,0	01616060
UNC Nr. 8	32	3,5	63	7	4,5	3,4	01616080
UNC Nr. 10	24	3,9	70	9	6,0	4,9	01616100
UNC Nr. 12	24	4,5	80	9	6,0	4,9	01616120
UNC 1/4	20	5,2	80	10	7,0	5,5	01616130
UNC 5/16	18	6,6	90	12	8,0	6,2	01616140
UNC 3/8	16	8,0	100	14	9,0	7,0	01616150
UNC 7/16	14	9,4	100	16	8,0	6,2	01616160
UNC 1/2	13	10,8	110	18	9,0	7,0	01616170
UNC 9/16	12	12,3	110	18	11,0	9,0	01616180
UNC 5/8	11	13,5	110	20	12,0	9,0	01616190
UNC 3/4	10	16,5	125	25	14,0	11,0	01616210
UNC 7/8	9	19,5	140	28	18,0	14,5	01616230
UNC 1	8	22,3	160	32	20,0	16,0	01616250
UNC 1.1/8	7	25,0	180	36	22,0	18,0	01616260
UNC 1.1/4	7	28,3	180	36	22,0	18,0	01616270
UNC 1.3/8	6	30,8	200	40	28,0	22,0	01616280
UNC 1.1/2	6	34,0	200	45	32,0	24,0	01616290
UNC 1.5/8	6	37,1	200	45	32,0	24,0	01616300
UNC 1.3/4	5	39,5	220	52	36,0	29,0	01616310
UNC 1.7/8	4,5	42,0	220	52	36,0	29,0	01616320
UNC 2	4,5	45,0	250	60	40,0	32,0	01616330
UNC 2.1/4	4,5	51,5	280	75	45	35	01616340
UNC 2.1/2	4	57,2	315	80	50	39	01616350
UNC 2.3/4	4	63,25	340	80	50	39	01616360
UNC 3	4	69,85	360	85	50	39	01616370

МАШИННЫЙ МЕТЧИК

ТЕХНИЧЕСКАЯ ИНФОРМАЦИЯ



Норма	DIN 2184-1	Вид отверстия	глухое <1.1/2xd
Резьба	UNC	Направление	правый
Материал	HSSE-G	Класс точности	6h
Форма	Форма С	Обр. Материал	Сталь

Машинный метчик ≤ 3/8 с утолщённым хвостовиком, 2-3 витка резьбы, с прямой канавкой

Иконка	М	М	М	М	М	М	Арт.-Нр.
UNC Nr. 4	40	2,3	56	11	3,5	2,7	01621040
UNC Nr. 5	40	2,6	56	11	3,5	2,7	01621050
UNC Nr. 6	32	2,9	56	12	4,0	3,0	01621060
UNC Nr. 8	32	3,5	63	13	4,5	3,4	01621080
UNC Nr. 10	24	3,9	70	15	6,0	4,9	01621100
UNC Nr. 12	24	4,5	80	16	6,0	4,9	01621120
UNC 1/4	20	5,2	80	17	7,0	5,5	01621130
UNC 5/16	18	6,6	90	20	8,0	6,2	01621140
UNC 3/8	16	8,0	100	22	9,0	7,0	01621150
UNC 7/16	14	9,4	100	22	8,0	6,2	01621160
UNC 1/2	13	10,8	110	24	9,0	7,0	01621170
UNC 9/16	12	12,3	110	26	11,0	9,0	01621180
UNC 5/8	11	13,5	110	27	12,0	9,0	01621190
UNC 3/4	10	16,5	125	30	14,0	11,0	01621210
UNC 7/8	9	19,5	140	32	18,0	14,5	01621230
UNC 1	8	22,3	160	36	20,0	16,0	01621250
UNC 1.1/8	7	25,0	180	40	22,0	18,0	01621260
UNC 1.1/4	7	28,3	180	40	22,0	18,0	01621270
UNC 1.3/8	6	30,8	200	45	28,0	22,0	01621280
UNC 1.1/2	6	34,0	200	45	32,0	24,0	01621290
UNC 1.5/8	6	37,10	200	56	32,0	24,0	01621300
UNC 1.3/4	5	39,5	220	63	36,0	29,0	01621310
UNC 1.7/8	4,5	42,0	220	63	36,0	29,0	01621320
UNC 2	4,5	45,0	250	70	40,0	32,0	01621330
UNC 2.1/4	4,5	51,5	280	75	45	35	01621340
UNC 2.1/2	4	57,2	315	80	50	39	01621350
UNC 2.3/4	4	63,25	340	80	50	39	01621360
UNC 3	4	69,85	360	85	50	39	01621370

МАШИННЫЙ МЕТЧИК



ТЕХНИЧЕСКАЯ ИНФОРМАЦИЯ

Норма	DIN 2184-1	Вид отверстия	сквозное <1.1/2xd
Резьба	UNF	Направление	правый
Материал	HSSE-G	Класс точности	6h
Форма	Форма В	Обр. Материал	VA-Сталь

Машинный метчик ≤ 3/8 с утолщённым хвостовиком, 4–5 витков резьбы, с прямой канавкой, со спиральной подточкой (стружколом)

							Арт.-Нр.
UNF Nr. 2	64	1,85	45	9	2,8	2,1	01704020
UNF Nr. 3	56	2,1	50	9	2,8	2,1	01704030
UNF Nr. 4	48	2,4	56	11	3,5	2,7	01704040
UNF Nr. 5	44	2,7	56	11	3,5	2,7	01704050
UNF Nr. 6	40	3,0	56	12	4,0	3,0	01704060
UNF Nr. 8	36	3,5	63	13	4,5	3,4	01704080
UNF Nr. 10	32	4,1	70	15	6,0	4,9	01704100
UNF Nr. 12	28	4,65	80	16	6,0	4,9	01704120
UNF 1/4	28	5,5	80	17	7,0	5,5	01704130
UNF 5/16	24	6,9	90	20	8,0	6,2	01704140
UNF 3/8	24	8,5	100	22	9,0	7,0	01704150
UNF 7/16	20	9,9	100	22	8,0	6,2	01704160
UNF 1/2	20	11,5	100	22	9,0	7,0	01704170
UNF 9/16	18	13,0	100	22	11,0	9,0	01704180
UNF 5/8	18	14,5	100	22	12,0	9,0	01704190
UNF 3/4	16	17,5	110	25	14,0	11,0	01704210
UNF 7/8	14	20,5	125	25	18,0	14,5	01704230
UNF 1	12	23,3	140	28	18,0	14,5	01704250
UNF 1.1/8	12	26,5	150	28	22,0	18,0	01704270
UNF 1.1/4	12	29,5	150	28	22,0	18,0	01704280
UNF 1.3/8	12	32,5	170	30	28,0	22,0	01704290
UNF 1.1/2	12	36,0	170	30	28,0	22,0	01704300

МАШИННЫЙ МЕТЧИК



ТЕХНИЧЕСКАЯ ИНФОРМАЦИЯ

Норма	DIN 2184-1	Вид отверстия	сквозное <1.1/2xd
Резьба	UNF	Направление	правый
Материал	HSSE-G / VAP	Класс точности	6h
Форма	Форма В	Обр. Материал	VA-Сталь

Машинный метчик ≤ 3/8 с утолщённым хвостовиком, 4–5 витков резьбы, с прямой канавкой, со спиральной подточкой (стружколом), vaporизированный

							Арт.-Нр.
UNF Nr. 2	64	1,85	45	9	2,8	2,1	01705020
UNF Nr. 3	56	2,1	50	9	2,8	2,1	01705030
UNF Nr. 4	48	2,4	56	11	3,5	2,7	01705040
UNF Nr. 5	44	2,7	56	11	3,5	2,7	01705050
UNF Nr. 6	40	3,0	56	12	4,0	3,0	01705060
UNF Nr. 8	36	3,5	63	13	4,5	3,4	01705080
UNF Nr. 10	32	4,1	70	15	6,0	4,9	01705100
UNF Nr. 12	28	4,65	80	16	6,0	4,9	01705120
UNF 1/4	28	5,5	80	17	7,0	5,5	01705130
UNF 5/16	24	6,9	90	20	8,0	6,2	01705140
UNF 3/8	24	8,5	100	22	9,0	7,0	01705150
UNF 7/16	20	9,9	100	22	8,0	6,2	01705160
UNF 1/2	20	11,5	100	22	9,0	7,0	01705170
UNF 9/16	18	13,0	100	22	11,0	9,0	01705180
UNF 5/8	18	14,5	100	22	12,0	9,0	01705190
UNF 3/4	16	17,5	110	25	14,0	11,0	01705210
UNF 7/8	14	20,5	125	25	18,0	14,5	01705230
UNF 1	12	23,3	140	28	18,0	14,5	01705250
UNF 1.1/8	12	26,5	150	28	22,0	18,0	01705270
UNF 1.1/4	12	29,5	150	28	22,0	18,0	01705280
UNF 1.3/8	12	32,5	170	30	28,0	22,0	01705290
UNF 1.1/2	12	36,0	170	30	28,0	22,0	01705300

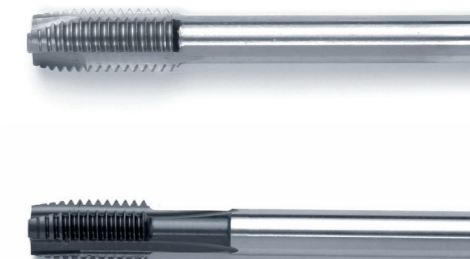

МАШИННЫЙ МЕТЧИК



ТЕХНИЧЕСКАЯ ИНФОРМАЦИЯ

Норма	DIN 2184-1	Вид отверстия	глухое < 3xd
Резьба	UNF	Направление	правый
Материал	HSSE-G	Класс точности	6h
Форма	Форма С / RSP 35°	Обр. Материал	Сталь

Машинный метчик ≤ 3/8 с утолщённым хвостовиком, 2-3 витка резьбы, со спиральной канавкой 35 градусов

UNF	мм	мм	мм	мм	мм	мм	Арт.-Нр.
UNF Nr. 2	64	1,85	45	5	2,8	2,1	01715020
UNF Nr. 3	56	2,1	50	5	2,8	2,1	01715030
UNF Nr. 4	48	2,4	56	5	3,5	2,4	01715040
UNF Nr. 5	44	2,7	56	5	3,5	2,7	01715050
UNF Nr. 6	40	3,0	56	6	4,0	3,0	01715060
UNF Nr. 8	36	3,5	63	8	4,5	3,4	01715080
UNF Nr. 10	32	4,1	70	8	6,0	4,9	01715100
UNF Nr. 12	28	4,65	80	9	6,0	4,9	01715120
UNF 1/4	28	5,5	80	10	7,0	5,5	01715130
UNF 5/16	24	6,9	90	12	8,0	6,2	01715140
UNF 3/8	24	8,5	100	12	9,0	7,0	01715150
UNF 7/16	20	9,9	100	22	8,0	6,2	01715160
UNF 1/2	20	11,5	100	22	9,0	7,0	01715170
UNF 9/16	18	13,0	100	22	11,0	9,0	01715180
UNF 5/8	18	14,5	100	22	12,0	9,0	01715190
UNF 3/4	16	17,5	110	25	14,0	11,0	01715210
UNF 7/8	14	20,5	125	25	18,0	14,5	01715230
UNF 1	12	23,3	140	28	18,0	14,5	01715250
UNF 1.1/8	12	26,5	150	28	22,0	18,0	01715270
UNF 1.1/4	12	29,5	150	28	22,0	18,0	01715280
UNF 1.3/8	12	32,5	170	30	28,0	22,0	01715290
UNF 1.1/2	12	36,0	170	30	28,0	22,0	01715300

МАШИННЫЙ МЕТЧИК



ТЕХНИЧЕСКАЯ ИНФОРМАЦИЯ

Норма	DIN 2184-1	Вид отверстия	глухое < 3xd
Резьба	UNF	Направление	правый
Материал	HSSE-G / VAP	Класс точности	6h
Форма	Форма С / RSP 35°	Обр. Материал	VA-Сталь

Машинный метчик ≤ 3/8 с утолщённым хвостовиком, 2-3 витка резьбы, со спиральной канавкой 35 градусов, вапоризированный

UNF	мм	мм	мм	мм	мм	мм	Арт.-Нр.
UNF Nr. 2	64	1,85	45	5	2,8	2,1	01716020
UNF Nr. 3	56	2,1	50	5	2,8	2,1	01716030
UNF Nr. 4	48	2,4	56	5	3,5	2,4	01716040
UNF Nr. 5	44	2,7	56	5	3,5	2,7	01716050
UNF Nr. 6	40	3,0	56	6	4,0	3,0	01716060
UNF Nr. 8	36	3,5	63	8	4,5	3,4	01716080
UNF Nr. 10	32	4,1	70	8	6,0	4,9	01716100
UNF Nr. 12	28	4,65	80	9	6,0	4,9	01716120
UNF 1/4	28	5,5	80	10	7,0	5,5	01716130
UNF 5/16	24	6,9	90	12	8,0	6,2	01716140
UNF 3/8	24	8,5	100	12	9,0	7,0	01716150
UNF 7/16	20	9,9	100	22	8,0	6,2	01716160
UNF 1/2	20	11,5	100	22	9,0	7,0	01716170
UNF 9/16	18	13,0	100	22	11,0	9,0	01716180
UNF 5/8	18	14,5	100	22	12,0	9,0	01716190
UNF 3/4	16	17,5	110	25	14,0	11,0	01716210
UNF 7/8	14	20,5	125	25	18,0	14,5	01716230
UNF 1	12	23,3	140	28	18,0	14,5	01716250
UNF 1.1/8	12	26,5	150	28	22,0	18,0	01716270
UNF 1.1/4	12	29,5	150	28	22,0	18,0	01716280
UNF 1.3/8	12	32,5	170	30	28,0	22,0	01716290
UNF 1.1/2	12	36,0	170	30	28,0	22,0	01716300

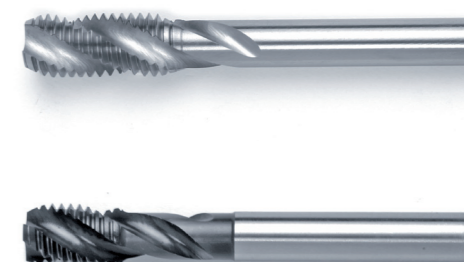

МАШИННЫЙ МЕТЧИК



ТЕХНИЧЕСКАЯ ИНФОРМАЦИЯ

Норма	DIN 2184-1	Вид отверстия	глухое < 1.1/2xd
Резьба	UNF	Направление	правый
Материал	HSSE-G	Класс точности	6h
Форма	Форма С	Обр. Материал	Сталь

Машинный метчик ≤ 3/8 с утолщённым хвостовиком, 2-3 витка резьбы, с прямой канавкой

Символ	М	Н	М	Н	М	Н	Арт.-Нр.
UNF Nr. 4	48	2,4	56	11	3,5	2,7	01721040
UNF Nr. 5	44	2,7	56	11	3,5	2,7	01721050
UNF Nr. 6	40	3,0	56	12	4,0	3,0	01721060
UNF Nr. 8	36	3,5	63	13	4,5	3,4	01721080
UNF Nr. 10	32	4,10	70	15	6,0	4,9	01721100
UNF Nr. 12	28	4,65	80	16	6,0	4,9	01721120
UNF 1/4	28	5,5	80	17	7,0	5,5	01721130
UNF 5/16	24	6,9	90	20	8,0	6,2	01721140
UNF 3/8	24	8,5	100	22	9,0	7,0	01721150
UNF 7/16	20	9,9	100	22	8,0	6,2	01721160
UNF 1/2	20	11,5	100	22	9,0	7,0	01721170
UNF 9/16	18	13,0	100	22	11,0	9,0	01721180
UNF 5/8	18	14,5	100	22	12,0	9,0	01721190
UNF 3/4	16	17,5	110	25	14,0	11,0	01721210
UNF 7/8	14	20,5	125	25	18,0	14,5	01721230
UNF 1	12	23,3	140	28	18,0	14,5	01721250
UNF 1.1/8	12	26,5	150	28	22,0	18,0	01721270
UNF 1.1/4	12	29,5	150	28	22,0	18,0	01721280
UNF 1.3/8	12	32,5	170	30	28,0	22,0	01721290
UNF 1.1/2	12	36,0	170	30	28,0	22,0	01721300

МАШИННЫЙ МЕТЧИК



ТЕХНИЧЕСКАЯ ИНФОРМАЦИЯ

Норма	DIN 2184-1	Вид отверстия	сквозное < 1.1/2xd
Резьба	UNEF	Направление	правый
Материал	HSSE-G	Класс точности	6h
Форма	Форма В	Обр. Материал	Сталь

Машинный метчик ≤ 3/8 с утолщённым хвостовиком, 4-5 витков резьбы, с прямой канавкой, со спиральной подточкой (стружколом)

Символ	М	Н	М	Н	М	Н	Арт.-Нр.
UNEF Nr. 12	32	4,8	80	16	6,0	4,9	01722120
UNEF 1/4	32	5,7	80	17	7,0	5,5	01722130
UNEF 5/16	32	7,25	90	20	8,0	6,2	01722140
UNEF 3/8	32	8,85	100	22	9,0	7,0	01722150
UNEF 7/16	28	10,35	100	22	8,0	6,2	01722160
UNEF 1/2	28	11,8	100	22	9,0	7,0	01722170
UNEF 9/16	24	13,4	100	22	11,0	9,0	01722180
UNEF 5/8	24	15	100	22	12,0	9,0	01722190
UNEF 3/4	20	18	110	25	14,0	11,0	01722210
UNEF 7/8	20	21,15	125	25	18,0	14,5	01722230
UNEF 1	20	24,3	140	28	18,0	14,5	01722250
UNEF 1.1/8	18	27,35	150	28	22,0	18,0	01722270
UNEF 1.1/4	18	30,55	150	28	22,0	18,0	01722280
UNEF 1.3/8	18	33,7	170	30	28,0	22,0	01722290
UNEF 1.1/2	18	36,9	170	30	28,0	22,0	01722300

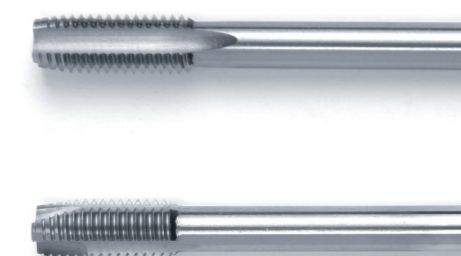

МАШИННЫЙ МЕТЧИК



ТЕХНИЧЕСКАЯ ИНФОРМАЦИЯ

Норма	DIN 2184-1	Вид отверстия	глухое < 3xd
Резьба	UNEF	Направление	правый
Материал	HSSE-G	Класс точности	6h
Форма	Форма С / RSP 35°	Обр. Материал	Сталь

Машинный метчик ≤ 3/8 с утолщённым хвостовиком, 2-3 витка резьбы, со спиральной канавкой 35 градусов

Сечение	М	М	М	М	М	М	Арт.-Нр.
UNEF Nr. 12	32	4,8	80	9	6,0	4,9	01723120
UNEF 1/4	32	5,7	80	10	7,0	5,5	01723130
UNEF 5/16	32	7,25	90	12	8,0	6,2	01723140
UNEF 3/8	32	8,85	100	12	9,0	7,0	01723150
UNEF 7/16	28	10,35	100	22	8,0	6,2	01723160
UNEF 1/2	28	11,8	100	22	9,0	7,0	01723170
UNEF 9/16	24	13,4	100	22	11,0	9,0	01723180
UNEF 5/8	24	15	100	22	12,0	9,0	01723190
UNEF 3/4	20	18	110	25	14,0	11,0	01723210
UNEF 7/8	20	21,15	125	25	18,0	14,5	01723230
UNEF 1	20	24,3	140	28	18,0	14,5	01723250
UNEF 1.1/8	18	27,35	150	28	22,0	18,0	01723270
UNEF 1.1/4	18	30,55	150	28	22,0	18,0	01723280
UNEF 1.3/8	18	33,7	170	30	28,0	22,0	01723290
UNEF 1.1/2	18	36,9	170	30	28,0	22,0	01723300

МАШИННЫЙ МЕТЧИК



ТЕХНИЧЕСКАЯ ИНФОРМАЦИЯ

Норма	DIN 2184-1	Вид отверстия	сквозное < 1.1/2xd
Резьба	UN / UNS	Направление	правый
Материал	HSSE-G	Класс точности	2b
Форма	Форма В	Обр. Материал	Сталь

Машинный метчик Überlaufschaft, 4-5 витков резьбы, с прямой канавкой

Сечение	М	М	М	М	М	М	Арт.-Нр.
UN 1.1/8	8	25,4	180	50	22,0	18,0	02804110
UN 1.1/4	8	28,6	180	50	25,0	20,0	02804130
UN 1.3/8	8	31,75	180	50	28,0	22,0	02804150
UN 1.1/2	8	34,9	180	50	32,0	24,0	02804160
UN 1.5/8	12	39,2	200	55	32,0	24,0	02804170
UN 1.5/8	8	38,1	200	55	32,0	24,0	02804180
UN 1.3/4	12	42,4	200	55	36,0	29,0	02804190
UN 1.3/4	8	41,3	200	55	36,0	29,0	02804200
UN 1.7/8	12	45,5	220	60	36,0	29,0	02804210
UN 1.7/8	8	44,5	220	60	36,0	29,0	02804220
UN 2	12	48,7	220	60	40,0	32,0	02804230
UN 2	8	47,7	220	60	40,0	32,0	02804240

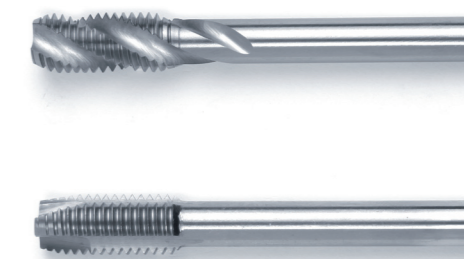

МАШИННЫЙ МЕТЧИК

ТЕХНИЧЕСКАЯ ИНФОРМАЦИЯ



Норма	DIN 2184-1	Вид отверстия	глухое < 3xd
Резьба	UN / UNS	Направление	правый
Материал	HSSE-G	Класс точности	2b
Форма	Форма C / RSP 35°	Обр. Материал	Сталь

Машинный метчик с проходным хвостовиком, 2-3 витка резьбы, со спиральной канавкой 35 градусов

UN	Ф	Н	К	М	С	Д	Арт.-Нр.
UN 1.1/8	8	25,4	180	50	22,0	18,0	02815110
UN 1.1/4	8	28,6	180	50	25,0	20,0	02815130
UN 1.3/8	8	31,75	180	50	28,0	22,0	02815150
UN 1.1/2	8	34,9	180	50	32,0	24,0	02815160
UN 1.5/8	12	39,2	200	55	32,0	24,0	02815170
UN 1.5/8	8	38,1	200	55	32,0	24,0	02815180
UN 1.3/4	12	42,4	200	55	36,0	29,0	02815190
UN 1.3/4	8	41,3	200	55	36,0	29,0	02815200
UN 1.7/8	12	45,5	220	60	36,0	29,0	02815210
UN 1.7/8	8	44,5	220	60	36,0	29,0	02815220
UN 2	12	48,7	220	60	40,0	32,0	02815230
UN 2	8	47,7	220	60	40,0	32,0	02815240

МАШИННЫЙ МЕТЧИК

ТЕХНИЧЕСКАЯ ИНФОРМАЦИЯ



Норма	DIN 2184-1	Вид отверстия	глухое < 1.1/2xd
Резьба	UN / UNS	Направление	правый
Материал	HSSE-G	Класс точности	2b
Форма	Форма C	Обр. Материал	Сталь

Машинный метчик Überlaufschaft, 2-3 витка резьбы

UNS	Ф	Н	К	М	С	Д	Арт.-Нр.
UNS 1/4	40	5,7	80	17	7,0	5,5	02821010
UNS 1/4	36	5,65	80	17	7,0	5,5	02821020
UNS 1/4	24	5,3	80	17	7,0	5,5	02821030
UNS 7/16	24	10,1	100	22	8,0	6,2	02821040
UNS 1/2	24	11,65	100	22	9,0	7,0	02821050
UN 9/16	20	13,0	100	22	11,0	9,0	02821060
UN 11/16	20	16,2	110	25	14,0	11,0	02821070
UN 11/16	16	15,9	110	25	14,0	11,0	02821080
UNS 1	14	23,6	150	32	20,0	16,0	02821090
UN 1.1/16	12	24,9	150	32	20,0	16,0	02821100
UN 1.1/8	8	25,4	180	50	22,0	18,0	02821110
UN 1.3/16	12	28,10	180	50	22,0	18,0	02821120
UN 1.1/4	8	28,6	180	50	25,0	20,0	02821130
UN 1.5/16	12	31,3	180	50	25,0	20,0	02821140
UN 1.3/8	8	31,75	180	50	28,0	22,0	02821150
UN 1.1/2	8	34,9	180	50	32,0	24,0	02821160
UN 1.5/8	12	39,2	200	55	32,0	24,0	02821170
UN 1.5/8	8	38,1	200	55	32,0	24,0	02821180
UN 1.3/4	12	42,4	200	55	36,0	29,0	02821190
UN 1.3/4	8	41,3	200	55	36,0	29,0	02821200
UN 1.7/8	12	45,5	220	60	36,0	29,0	02821210
UN 1.7/8	8	44,5	220	60	36,0	29,0	02821220
UN 2	12	48,7	220	60	40,0	32,0	02821230
UN 2	8	47,7	220	60	40,0	32,0	02821240
UN 2.1/4	8	54,0	260	65	45,0	35,0	02821250
UN 2.1/2	8	60,3	260	65	50,0	39,0	02821260
UN 2.3/4	8	66,7	260	65	56,0	44,0	02821270
UN 3	8	73,0	260	65	56,0	44,0	02821280

МАШИННЫЙ МЕТЧИК

ТЕХНИЧЕСКАЯ ИНФОРМАЦИЯ



Норма	DIN 2184-1	Вид отверстия	Сквозное / глухое
Резьба	Pg	Направление	правый
Материал	HSSE-G	Класс точности	6h
Форма	Форма С	Обр. Материал	Сталь

Машинный метчик с проходным хвостовиком, 2-3 витка резьбы, с прямой канавкой, für Сталь-PanzerrohrРезьба

							Арт.-Нр.
Pg 7	20	11,4	100	22	9,0	7,0	02901010
Pg 9	18	14,0	100	22	12,0	9,0	02901020
Pg 11	18	17,3	110	25	14,0	11,0	02901030
Pg 13,5	18	19,0	125	25	16,0	12,0	02901040
Pg 16	18	21,3	125	25	18,0	14,5	02901050
Pg 21	16	27,0	150	28	22,0	18,0	02901060
Pg 29	16	35,5	170	30	28,0	22,0	02901070
Pg 36	16	45,5	190	32	36,0	29,0	02901080
Pg 42	16	52,5	190	32	40,0	32,0	02901090
Pg 48	16	58,0	220	40	45,0	32,0	02901100

МАШИННЫЙ МЕТЧИК

ТЕХНИЧЕСКАЯ ИНФОРМАЦИЯ



Норма	DIN 374	Вид отверстия	Сквозное / глухое
Резьба	Rd	Направление	правый
Материал	HSSE-G	Класс точности	7h
Форма	Форма С	Обр. Материал	Сталь

Машинный метчик с проходным хвостовиком, 2-3 витка резьбы, с прямой канавкой, RundРезьба DIN 405

							Арт.-Нр.
Rd 8	10	5,7	90	26	6	4,9	02951010
Rd 9	10	6,7	90	26	9,0	5,5	02951020
Rd 10	10	7,7	100	26	7	5,5	02951030
Rd 12	10	9,7	110	26	9	7	02951040
Rd 14	8	11,2	110	32	11	9	02951050
Rd 16	8	13,2	110	32	12	9,0	02951060
Rd 18	8	15,2	125	34	14	11	02951070
Rd 20	8	17,2	140	34	16	12	02951080
Rd 22	8	19,2	140	34	18	14,5	02951090
Rd 24	8	21,2	160	38	18,0	14,5	02951100
Rd 26	8	23,2	160	38	18	14,5	02951110
Rd 28	8	25,2	160	38	20	16	02951120
Rd 30	8	27,2	180	45	22,0	18	02951130
Rd 32	8	29,2	180	45	25,0	20,0	02951140
Rd 34	8	31,2	200	56	28,0	22,0	02951150
Rd 36	8	33,2	200	56	28,0	22,0	02951160

МАШИННЫЙ МЕТЧИК LH

ТЕХНИЧЕСКАЯ ИНФОРМАЦИЯ



Норма	DIN 371 (DIN 2184-1)	Вид отверстия	сквозное <1.1/2xd
Резьба	M	Направление	левый
Материал	HSSE-G	Класс точности	6h
Форма	Форма В	Обр. Материал	Сталь

Машинный метчик с утолщённым хвостовиком, 4-5 витков резьбы, со спиральной подточкой (стружколом)

							Арт.-Нр.
M 3	0,5	2,5	56	11	3,5	2,7	02107130
M 4	0,7	3,3	63	13	4,5	3,4	02107150
M 5	0,8	4,2	70	16	6,0	4,9	02107170
M 6	1,0	5,0	80	19	6,0	4,9	02107190
M 8	1,25	6,8	90	22	8,0	6,2	02107210
M 10	1,5	8,5	100	24	10,0	8,0	02107230

МАШИННЫЙ МЕТЧИК LH

ТЕХНИЧЕСКАЯ ИНФОРМАЦИЯ



Норма	DIN 376 (DIN 2184-1)	Вид отверстия	сквозное < 1.1/2xd
Резьба	M	Направление	левый
Материал	HSSE-G	Класс точности	6h
Форма	Форма B	Обр. Материал	Сталь

Машинный метчик с проходным хвостовиком, 4–5 витков резьбы, со спиральной подточкой (стружколом)

М	0,5	2,5	56	11	2,2	—	Арт.-Нр.
M 3	0,5	2,5	56	11	2,2	—	02108130
M 4	0,7	3,3	63	13	2,8	2,1	02108150
M 5	0,8	4,2	70	16	3,5	2,7	02108170
M 6	1,0	5,0	80	19	4,5	3,4	02108190
M 8	1,25	6,8	90	22	6,0	4,9	02108210
M 10	1,5	8,5	100	24	7,0	5,5	02108230
M 12	1,75	10,2	110	28	9,0	7,0	02108250
M 14	2,0	12,0	110	30	11,0	9,0	02108260
M 16	2,0	14,0	110	32	12,0	9,0	02108270
M 18	2,5	15,5	125	34	14,0	11,0	02108280
M 20	2,5	17,5	140	34	16,0	12,0	02108290
M 22	2,5	19,5	140	34	18,0	14,5	02108300
M 24	3,0	21,0	160	38	18,0	14,5	02108310
M 27	3,0	24,0	160	38	20,0	16,0	02108320
M 30	3,5	26,5	180	45	22,0	18,0	02108330
M 33	3,5	29,5	180	50	25,0	20,0	02108340
M 36	4,0	32,0	200	56	28,0	22,0	02108350
M 39	4,0	35,0	200	60	32,0	24,0	02108360
M 42	4,5	37,5	200	60	32,0	24,0	02108370
M 45	4,5	40,5	220	65	36,0	29,0	02108380
M 48	5,0	43,0	250	70	36,0	29,0	02108390
M 52	5,0	47,0	250	70	40,0	32,0	02108400

МАШИННЫЙ МЕТЧИК LH

ТЕХНИЧЕСКАЯ ИНФОРМАЦИЯ



Норма	DIN 371 (DIN 2184-1)	Вид отверстия	сквозное / глухое
Резьба	M	Направление	левый
Материал	HSSE-G	Класс точности	6h
Форма	Форма C	Обр. Материал	Сталь

Машинный метчик с утолщённым хвостовиком, 2-3 витка резьбы, с прямой канавкой

М	0,5	2,5	56	11	3,5	2,7	Арт.-Нр.
M 3	0,5	2,5	56	11	3,5	2,7	01028130
M 4	0,7	3,3	63	13	4,5	3,4	01028150
M 5	0,8	4,2	70	16	6,0	4,9	01028170
M 6	1,0	5,0	80	19	6,0	4,9	01028190
M 8	1,25	6,8	90	22	8,0	6,2	01028210
M 10	1,5	8,5	100	24	10,0	8,0	01028230

МАШИННЫЙ МЕТЧИК LH

ТЕХНИЧЕСКАЯ ИНФОРМАЦИЯ



Норма	DIN 376 (DIN 2184-1)	Вид отверстия	сквозное / глухое
Резьба	M	Направление	левый
Материал	HSSE-G	Класс точности	6h
Форма	Форма C	Обр. Материал	Сталь

Машинный метчик с проходным хвостовиком, 2-3 витка резьбы, с прямой канавкой

М	0,5	2,5	56	11	2,2	—	Арт.-Нр.
M 3	0,5	2,5	56	11	2,2	—	02028130
M 4	0,7	3,3	63	13	2,8	2,1	02028150
M 5	0,8	4,2	70	16	3,5	2,7	02028170
M 6	1,0	5,0	80	19	4,5	3,4	02028190
M 8	1,25	6,8	90	22	6,0	4,9	02028210
M 10	1,5	8,5	100	24	7,0	5,5	02028230
M 12	1,75	10,2	110	28	9,0	7,0	02028250
M 14	2,0	12,0	110	30	11,0	9,0	02028260
M 16	2,0	14,0	110	32	12,0	9,0	02028270
M 18	2,5	15,5	125	34	14,0	11,0	02028280
M 20	2,5	17,5	140	34	16,0	12,0	02028290
M 22	2,5	19,5	140	34	18,0	14,5	02028300
M 24	3,0	21,0	160	38	18,0	14,5	02028310
M 27	3,0	24,0	160	38	20,0	16,0	02028320
M 30	3,5	26,5	180	45	22,0	18,0	02028330
M 33	3,5	29,5	180	50	25,0	20,0	02028340

							Арт.-Нр.
M 36	4,0	32,0	200	56	28,0	22,0	02028350
M 39	4,0	35,0	200	60	32,0	24,0	02028360
M 42	4,5	37,5	200	60	32,0	24,0	02028370
M 45	4,5	40,5	220	65	36,0	29,0	02028380
M 48	5,0	43,0	250	70	36,0	29,0	02028390
M 52	5,0	47,0	250	70	40,0	32,0	02028400

							Арт.-Нр.
MF 13 × 0,75	0,75	12,25	100	18	11,0	9,0	02237240
MF 13 × 1	1,0	12,0	100	22	11,0	9,0	02237250
MF 13 × 1,25	1,25	11,75	100	18	11,0	9,0	02237260
MF 13 × 1,5	1,5	11,5	100	22	11,0	9,0	02237270
MF 14 × 0,5	0,5	13,5	100	18	11,0	9,0	02237280
MF 14 × 0,75	0,75	13,25	100	22	11,0	9,0	02237290
MF 14 × 1	1,0	13,0	100	22	11,0	9,0	02237300
MF 14 × 1,25	1,25	12,75	100	22	11,0	9,0	02237310
MF 14 × 1,5	1,5	12,5	100	18	11,0	9,0	02237320
MF 15 × 0,5	0,5	14,5	100	18	12,0	9,0	02237330
MF 15 × 0,75	0,75	14,25	100	18	12,0	9,0	02237340
MF 15 × 1	1,0	14,0	100	22	12,0	9,0	02237350
MF 15 × 1,25	1,25	13,8	100	22	12,0	9,0	02237360
MF 15 × 1,5	1,5	13,5	100	22	12,0	9,0	02237370
MF 16 × 0,5	0,5	15,5	100	18	12,0	9,0	02237380
MF 16 × 0,75	0,75	15,25	100	18	12,0	9,0	02237390
MF 16 × 1	1,0	15,0	100	22	12,0	9,0	02237400
MF 16 × 1,25	1,25	14,75	100	22	12,0	9,0	02237410
MF 16 × 1,5	1,5	14,5	100	18	12,0	9,0	02237420
MF 17 × 0,75	0,75	16,25	100	18	12,0	9,0	02237430
MF 17 × 1	1,0	16,0	100	18	12,0	9,0	02237440
MF 17 × 1,5	1,5	15,5	100	22	12,0	9,0	02237450
MF 18 × 0,75	0,75	17,25	110	20	14,0	11,0	02237460
MF 18 × 1	1,0	17,0	110	25	14,0	11,0	02237470
MF 18 × 1,25	1,25	16,75	110	25	14,0	11,0	02237480
MF 18 × 1,5	1,5	16,5	110	22	14,0	11,0	02237490
MF 18 × 2	2,0	16,0	125	28	14,0	11,0	02237500
MF 20 × 0,75	0,75	19,25	125	20	16,0	12,0	02237510
MF 20 × 1	1,0	19,0	125	25	16,0	12,0	02237520
MF 20 × 1,25	1,25	18,75	125	25	16,0	12,0	02237530
MF 20 × 1,5	1,5	18,5	125	25	16,0	12,0	02237540
MF 20 × 2	2,0	18,0	140	28	16,0	12,0	02237550
MF 21 × 1	1,0	20,0	125	20	16,0	12,0	02237560
MF 21 × 1,5	1,5	19,5	125	25	16,0	12,0	02237570
MF 22 × 0,75	0,75	21,25	125	20	18,0	14,5	02237580
MF 22 × 1	1,0	21,0	125	25	18,0	14,5	02237590
MF 22 × 1,25	1,25	20,75	125	25	18,0	14,5	02237600
MF 22 × 1,5	1,5	20,5	125	25	18,0	14,5	02237610
MF 22 × 2	2,0	20,0	140	28	18,0	14,5	02237620
MF 23 × 1	1,0	22,0	125	20	18,0	14,5	02237630
MF 23 × 1,5	1,5	21,5	125	20	18,0	14,5	02237640
MF 24 × 0,75	0,75	23,25	125	20	18,0	14,5	02237650
MF 24 × 1	1,0	23,0	125	20	18,0	14,5	02237660
MF 24 × 1,25	1,25	22,75	125	25	18,0	14,5	02237670

МАШИННЫЙ МЕТЧИК LH

ТЕХНИЧЕСКАЯ ИНФОРМАЦИЯ



Норма	DIN 374	Вид отверстия	Сквозное / глухое
Резьба	MF	Направление	левый
Материал	HSSE-G	Класс точности	6h
Форма	Форма С	Обр. Материал	Сталь

Машинный метчик с проходным хвостовиком, 2-3 витка резьбы, с прямой канавкой

							Арт.-Нр.
MF 3 × 0,35	0,35	2,65	56	8	2,2	1,9	02237000
MF 4 × 0,5	0,5	3,5	61	10	2,8	2,1	02237010
MF 5 × 0,5	0,5	4,5	70	1	3,5	2,7	02237020
MF 5 × 0,75	0,75	4,25	70	11	3,5	2,7	02237030
MF 6 × 0,5	0,5	5,5	80	12	4,5	3,4	02237040
MF 6 × 0,75	0,75	5,25	80	14	4,5	3,4	02237050
MF 7 × 0,75	0,75	6,25	80	14	5,5	4,3	02237060
MF 8 × 0,5	0,5	7,5	80	12	6,0	4,9	02237070
MF 8 × 0,75	0,75	7,25	80	14	6,0	4,9	02237080
MF 8 × 1	1,0	7,0	90	16	6,0	4,9	02237090
MF 9 × 1	1,0	8,0	90	16	7,0	5,5	02237100
MF 10 × 0,5	0,5	9,5	90	14	7,0	5,5	02237110
MF 10 × 0,75	0,75	9,25	90	14	7,0	5,5	02237120
MF 10 × 1	1,0	9,0	100	12	7,0	5,5	02237130
MF 10 × 1,25	1,25	8,75	100	20	7,0	5,5	02237140
MF 11 × 0,75	0,75	10,25	90	16	8,0	6,2	02237150
MF 11 × 1	1,0	10,0	90	16	8,0	6,2	02237160
MF 11 × 1,25	1,25	9,75	90	16	8,0	6,2	02237170
MF 12 × 0,5	0,5	11,5	100	18	9,0	7,0	02237180
MF 12 × 0,75	0,75	11,25	100	18	9,0	7,0	02237190
MF 12 × 1	1,0	11,0	100	22	9,0	7,0	02237200
MF 12 × 1,25	1,25	10,75	100	22	9,0	7,0	02237210
MF 12 × 1,5	1,5	10,5	100	14	9,0	7,0	02237220
MF 13 × 0,5	0,5	12,5	100	18	11,0	9,0	02237230

							Арт.-Нр.
MF 24 × 1,5	1,5	22,5	125	25	18,0	14,5	02237680
MF 24 × 2	2,0	22,0	140	28	18,0	14,5	02237690
MF 25 × 1	1,0	24,0	140	25	18,0	14,5	02237700
MF 25 × 1,5	1,5	23,5	140	25	18,0	14,5	02237710
MF 25 × 2	2,0	23,0	140	32	18,0	14,5	02237720
MF 26 × 1	1,0	25,0	140	25	18,0	14,5	02237730
MF 26 × 1,5	1,5	24,5	140	28	18,0	14,5	02237740
MF 26 × 2	2,0	24,0	140	32	18,0	14,5	02237750
MF 27 × 1	1,0	26,0	150	25	20,0	16,0	02237760
MF 27 × 1,5	1,5	25,5	140	28	20,0	16,0	02237770
MF 27 × 2	2,0	25,0	140	28	20,0	16,0	02237780
MF 28 × 1	1,0	27,0	150	25	20,0	16,0	02237790
MF 28 × 1,5	1,5	26,5	150	28	20,0	16,0	02237800
MF 28 × 2	2,0	26,0	140	28	20,0	16,0	02237810
MF 30 × 1	1,0	29,0	150	28	22,0	18,0	02237820
MF 30 × 1,5	1,5	28,5	150	28	22,0	18,0	02237830
MF 30 × 2	2,0	28,0	150	28	22,0	18,0	02237840
MF 30 × 3	3,0	27,0	160	36	22,0	18,0	02237850
MF 32 × 1	1,0	31,0	150	25	22,0	18,0	02237860
MF 32 × 1,5	1,5	30,5	150	28	22,0	18,0	02237870
MF 32 × 2	2,0	30,0	160	32	22,0	18,0	02237880
MF 32 × 3	3,0	29,0	160	36	22,0	18,0	02237890
MF 33 × 1	1,0	32,0	150	25	25,0	20,0	02237900
MF 33 × 1,5	1,5	31,5	160	28	25,0	20,0	02237910
MF 33 × 2	2,0	31,0	160	28	25,0	20,0	02237920
MF 33 × 3	3,0	30,0	160	36	25,0	20,0	02237930
MF 34 × 1	1,0	33,0	150	25	28,0	22,0	02237940
MF 34 × 1,5	1,5	32,5	170	28	28,0	22,0	02237950
MF 34 × 2	2,0	32,0	160	32	28,0	22,0	02237960
MF 34 × 3	3,0	31,0	160	36	28,0	22,0	02237970
MF 35 × 1	1,0	34,0	150	25	28,0	22,0	02237980
MF 35 × 1,5	1,5	33,5	170	28	28,0	22,0	02237990
MF 35 × 2	2,0	33,0	160	32	28,0	22,0	02238000
MF 35 × 3	3,0	32,0	160	36	28,0	22,0	02238010
MF 36 × 1	1,0	35,0	170	28	28,0	22,0	02238020
MF 36 × 1,5	1,5	34,5	170	28	28,0	22,0	02238030
MF 36 × 2	2,0	34,0	170	28	28,0	22,0	02238040
MF 36 × 3	3,0	33,0	200	36	28,0	22,0	02238050
MF 38 × 1	1,0	37,0	170	28	28,0	22,0	02238060
MF 38 × 1,5	1,5	36,5	170	28	28,0	22,0	02238070
MF 38 × 2	2,0	36,0	180	32	28,0	22,0	02238080
MF 38 × 3	3,0	35,0	190	36	28,0	22,0	02238090
MF 39 × 1,5	1,5	37,5	170	28	32,0	24,0	02238100
MF 39 × 2	2,0	37,0	170	28	32,0	24,0	02238110

							Арт.-Нр.
MF 39 × 3	3,0	36,0	200	36	32,0	24,0	02238120
MF 40 × 1,5	1,5	38,5	170	28	32,0	24,0	02238130
MF 40 × 2	2,0	38,0	170	28	32,0	24,0	02238140
MF 40 × 3	3,0	37,0	200	36	32,0	24,0	02238150
MF 42 × 1,5	1,5	40,5	180	32	32,0	24,0	02238160
MF 42 × 2	2,0	40,0	180	32	32,0	24,0	02238170
MF 42 × 3	3,0	39,0	200	36	32,0	24,0	02238180
MF 42 × 4	4,0	38,0	225	52	32,0	24,0	02238190
MF 45 × 1,5	1,5	43,5	180	32	36,0	29,0	02238200
MF 45 × 2	2,0	43,0	180	32	36,0	29,0	02238210
MF 45 × 3	3,0	42,0	200	36	36,0	29,0	02238220
MF 45 × 4	4,0	41,0	225	52	36,0	29,0	02238230
MF 48 × 1,5	1,5	46,5	190	32	36,0	29,0	02238240
MF 48 × 2	2,0	46,0	190	32	36,0	29,0	02238250
MF 48 × 3	3,0	45,0	225	36	36,0	29,0	02238260
MF 48 × 4	4,0	44,0	225	64	36,0	29,0	02238270
MF 50 × 1,5	1,5	48,5	190	32	36,0	29,0	02238280
MF 50 × 2	2,0	48,0	190	32	36,0	29,0	02238290
MF 50 × 3	3,0	47,0	225	36	36,0	29,0	02238300
MF 50 × 4	4,0	46,0	225	64	36,0	29,0	02238310
MF 52 × 1,5	1,5	50,5	190	32	40,0	32,0	02238320
MF 52 × 2	2,0	50,0	190	32	40,0	32,0	02238330
MF 52 × 3	3,0	49,0	225	40	40,0	32,0	02238340
MF 52 × 4	4,0	48,0	225	64	36,0	29,0	02238350

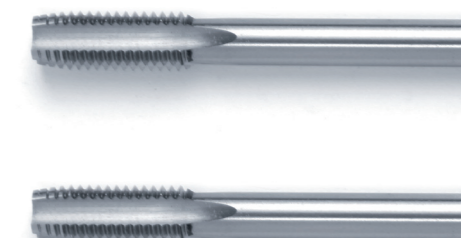

МАШИННЫЙ МЕТЧИК LH



ТЕХНИЧЕСКАЯ ИНФОРМАЦИЯ

Норма	DIN 374	Вид отверстия	глухое < 3хd
Резьба	MF	Направление	левый
Материал	HSSE-G	Класс точности	6h
Форма	Форма С / RSP 35°	Обр. Материал	Сталь

Машинный метчик с проходным хвостовиком, 2-3 витка резьбы, со спиральной канавкой 35 градусов

							Арт.-Нр.
MF 3 × 0,35	0,35	2,65	56	8	2,2	1,9	02239000
MF 4 × 0,5	0,5	3,5	61	10	2,8	2,1	02239010
MF 5 × 0,5	0,5	4,5	70	1	3,5	2,7	02239020
MF 5 × 0,75	0,75	4,25	70	11	3,5	2,7	02239030
MF 6 × 0,5	0,5	5,5	80	12	4,5	3,4	02239040
MF 6 × 0,75	0,75	5,25	80	14	4,5	3,4	02239050
MF 7 × 0,75	0,75	6,25	80	14	5,5	4,3	02239060
MF 8 × 0,5	0,5	7,5	80	12	6,0	4,9	02239070
MF 8 × 0,75	0,75	7,25	80	14	6,0	4,9	02239080
MF 8 × 1	1,0	7,0	90	16	6,0	4,9	02239090
MF 9 × 1	1,0	8,0	90	16	7,0	5,5	02239100
MF 10 × 0,5	0,5	9,5	90	14	7,0	5,5	02239110
MF 10 × 0,75	0,75	9,25	90	14	7,0	5,5	02239120
MF 10 × 1	1,0	9,0	100	12	7,0	5,5	02239130
MF 10 × 1,25	1,25	8,75	100	20	7,0	5,5	02239140
MF 11 × 0,75	0,75	10,25	90	16	8,0	6,2	02239150
MF 11 × 1	1,0	10,0	90	16	8,0	6,2	02239160
MF 11 × 1,25	1,25	9,75	90	16	8,0	6,2	02239170
MF 12 × 0,5	0,5	11,5	100	18	9,0	7,0	02239180
MF 12 × 0,75	0,75	11,25	100	18	9,0	7,0	02239190
MF 12 × 1	1,0	11,0	100	22	9,0	7,0	02239200
MF 12 × 1,25	1,25	10,75	100	22	9,0	7,0	02239210
MF 12 × 1,5	1,5	10,5	100	14	9,0	7,0	02239220
MF 13 × 0,5	0,5	12,5	100	18	11,0	9,0	02239230
MF 13 × 0,75	0,75	12,25	100	18	11,0	9,0	02239240
MF 13 × 1	1,0	12,0	100	22	11,0	9,0	02239250
MF 13 × 1,25	1,25	11,75	100	18	11,0	9,0	02239260
MF 13 × 1,5	1,5	11,5	100	22	11,0	9,0	02239270
MF 14 × 0,5	0,5	13,5	100	18	11,0	9,0	02239280
MF 14 × 0,75	0,75	13,25	100	22	11,0	9,0	02239290
MF 14 × 1	1,0	13,0	100	22	11,0	9,0	02239300
MF 14 × 1,25	1,25	12,75	100	22	11,0	9,0	02239310
MF 14 × 1,5	1,5	12,5	100	18	11,0	9,0	02239320
MF 15 × 0,5	0,5	14,5	100	18	12,0	9,0	02239330
MF 15 × 0,75	0,75	14,25	100	18	12,0	9,0	02239340
MF 15 × 1	1,0	14,0	100	22	12,0	9,0	02239350

							Арт.-Нр.
MF 15 × 1,25	1,25	13,8	100	22	12,0	9,0	02239360
MF 15 × 1,5	1,5	13,5	100	22	12,0	9,0	02239370
MF 16 × 0,5	0,5	15,5	100	18	12,0	9,0	02239380
MF 16 × 0,75	0,75	15,25	100	18	12,0	9,0	02239390
MF 16 × 1	1,0	15,0	100	22	12,0	9,0	02239400
MF 16 × 1,25	1,25	14,75	100	22	12,0	9,0	02239410
MF 16 × 1,5	1,5	14,5	100	18	12,0	9,0	02239420
MF 17 × 0,75	0,75	16,25	100	18	12,0	9,0	02239430
MF 17 × 1	1,0	16,0	100	18	12,0	9,0	02239440
MF 17 × 1,5	1,5	15,5	100	22	12,0	9,0	02239450
MF 18 × 0,75	0,75	17,25	110	20	14,0	11,0	02239460
MF 18 × 1	1,0	17,0	110	25	14,0	11,0	02239470
MF 18 × 1,25	1,25	16,75	110	25	14,0	11,0	02239480
MF 18 × 1,5	1,5	16,5	110	22	14,0	11,0	02239490
MF 18 × 2	2,0	16,0	125	28	14,0	11,0	02239500
MF 20 × 0,75	0,75	19,25	125	20	16,0	12,0	02239510
MF 20 × 1	1,0	19,0	125	25	16,0	12,0	02239520
MF 20 × 1,25	1,25	18,75	125	25	16,0	12,0	02239530
MF 20 × 1,5	1,5	18,5	125	25	16,0	12,0	02239540
MF 20 × 2	2,0	18,0	140	28	16,0	12,0	02239550
MF 21 × 1	1,0	20,0	125	20	16,0	12,0	02239560
MF 21 × 1,5	1,5	19,5	125	25	16,0	12,0	02239570
MF 22 × 0,75	0,75	21,25	125	20	18,0	14,5	02239580
MF 22 × 1	1,0	21,0	125	25	18,0	14,5	02239590
MF 22 × 1,25	1,25	20,75	125	25	18,0	14,5	02239600
MF 22 × 1,5	1,5	20,5	125	25	18,0	14,5	02239610
MF 22 × 2	2,0	20,0	140	28	18,0	14,5	02239620
MF 23 × 1	1,0	22,0	125	20	18,0	14,5	02239630
MF 23 × 1,5	1,5	21,5	125	20	18,0	14,5	02239640
MF 24 × 0,75	0,75	23,25	125	20	18,0	14,5	02239650
MF 24 × 1	1,0	23,0	125	20	18,0	14,5	02239660
MF 24 × 1,25	1,25	22,75	125	25	18,0	14,5	02239670
MF 24 × 1,5	1,5	22,5	125	25	18,0	14,5	02239680
MF 24 × 2	2,0	22,0	140	28	18,0	14,5	02239690
MF 25 × 1	1,0	24,0	140	25	18,0	14,5	02239700
MF 25 × 1,5	1,5	23,5	140	25	18,0	14,5	02239710
MF 25 × 2	2,0	23,0	140	32	18,0	14,5	02239720
MF 26 × 1	1,0	25,0	140	25	18,0	14,5	02239730
MF 26 × 1,5	1,5	24,5	140	28	18,0	14,5	02239740
MF 26 × 2	2,0	24,0	140	32	18,0	14,5	02239750
MF 27 × 1	1,0	26,0	150	25	20,0	16,0	02239760
MF 27 × 1,5	1,5	25,5	140	28	20,0	16,0	02239770
MF 27 × 2	2,0	25,0	140	28	20,0	16,0	02239780
MF 28 × 1	1,0	27,0	150	25	20,0	16,0	02239790

							Арт.-Нр.
MF 28 × 1,5	1,5	26,5	150	28	20,0	16,0	02239800
MF 28 × 2	2,0	26,0	140	28	20,0	16,0	02239810
MF 30 × 1	1,0	29,0	150	28	22,0	18,0	02239820
MF 30 × 1,5	1,5	28,5	150	28	22,0	18,0	02239830
MF 30 × 2	2,0	28,0	150	28	22,0	18,0	02239840
MF 30 × 3	3,0	27,0	160	36	22,0	18,0	02239850
MF 32 × 1	1,0	31,0	150	25	22,0	18,0	02239860
MF 32 × 1,5	1,5	30,5	150	28	22,0	18,0	02239870
MF 32 × 2	2,0	30,0	160	32	22,0	18,0	02239880
MF 32 × 3	3,0	29,0	160	36	22,0	18,0	02239890
MF 33 × 1	1,0	32,0	150	25	25,0	20,0	02239900
MF 33 × 1,5	1,5	31,5	160	28	25,0	20,0	02239910
MF 33 × 2	2,0	31,0	160	28	25,0	20,0	02239920
MF 33 × 3	3,0	30,0	160	36	25,0	20,0	02239930
MF 34 × 1	1,0	33,0	150	25	28,0	22,0	02239940
MF 34 × 1,5	1,5	32,5	170	28	28,0	22,0	02239950
MF 34 × 2	2,0	32,0	160	32	28,0	22,0	02239960
MF 34 × 3	3,0	31,0	160	36	28,0	22,0	02239970
MF 35 × 1	1,0	34,0	150	25	28,0	22,0	02239980
MF 35 × 1,5	1,5	33,5	170	28	28,0	22,0	02239990
MF 35 × 2	2,0	33,0	160	32	28,0	22,0	02240000
MF 35 × 3	3,0	32,0	160	36	28,0	22,0	02240010
MF 36 × 1	1,0	35,0	170	28	28,0	22,0	02240020
MF 36 × 1,5	1,5	34,5	170	28	28,0	22,0	02240030
MF 36 × 2	2,0	34,0	170	28	28,0	22,0	02240040
MF 36 × 3	3,0	33,0	200	36	28,0	22,0	02240050
MF 38 × 1	1,0	37,0	170	28	28,0	22,0	02240060
MF 38 × 1,5	1,5	36,5	170	28	28,0	22,0	02240070
MF 38 × 2	2,0	36,0	180	32	28,0	22,0	02240080
MF 38 × 3	3,0	35,0	190	36	28,0	22,0	02240090
MF 39 × 1,5	1,5	37,5	170	28	32,0	24,0	02240100
MF 39 × 2	2,0	37,0	170	28	32,0	24,0	02240110
MF 39 × 3	3,0	36,0	200	36	32,0	24,0	02240120
MF 40 × 1,5	1,5	38,5	170	28	32,0	24,0	02240130
MF 40 × 2	2,0	38,0	170	28	32,0	24,0	02240140
MF 40 × 3	3,0	37,0	200	36	32,0	24,0	02240150
MF 42 × 1,5	1,5	40,5	180	32	32,0	24,0	02240160
MF 42 × 2	2,0	40,0	180	32	32,0	24,0	02240170
MF 42 × 3	3,0	39,0	200	36	32,0	24,0	02240180
MF 42 × 4	4,0	38,0	225	52	32,0	24,0	02240190
MF 45 × 1,5	1,5	43,5	180	32	36,0	29,0	02240200
MF 45 × 2	2,0	43,0	180	32	36,0	29,0	02240210
MF 45 × 3	3,0	42,0	200	36	36,0	29,0	02240220
MF 45 × 4	4,0	41,0	225	52	36,0	29,0	02240230

							Арт.-Нр.
MF 48 × 1,5	1,5	46,5	190	32	36,0	29,0	02240240
MF 48 × 2	2,0	46,0	190	32	36,0	29,0	02240250
MF 48 × 3	3,0	45,0	225	36	36,0	29,0	02240260
MF 48 × 4	4,0	44,0	225	64	36,0	29,0	02240270
MF 50 × 1,5	1,5	48,5	190	32	36,0	29,0	02240280
MF 50 × 2	2,0	48,0	190	32	36,0	29,0	02240290
MF 50 × 3	3,0	47,0	225	36	36,0	29,0	02240300
MF 50 × 4	4,0	46,0	225	64	36,0	29,0	02240310
MF 52 × 1,5	1,5	50,5	190	32	40,0	32,0	02240320
MF 52 × 2	2,0	50,0	190	32	40,0	32,0	02240330
MF 52 × 3	3,0	49,0	225	40	40,0	32,0	02240340
MF 52 × 4	4,0	48,0	225	64	36,0	29,0	02240350

МАШИННЫЙ МЕТЧИК LH

ТЕХНИЧЕСКАЯ ИНФОРМАЦИЯ



Норма	DIN 5156	Вид отверстия	Сквозное / глухое
Резьба	BSP	Направление	левый
Материал	HSSE-G	Класс точности	6h
Форма	Форма С	Обр. Материал	Сталь

Машинный метчик с проходным хвостовиком, 2-3 витка резьбы, с прямой канавкой

							Арт.-Нр.
BSP 1/8	28	8,8	90	20	7,0	5,5	02522020
BSP 1/4	19	11,8	100	22	11,0	9,0	02522060
BSP 3/8	19	15,3	100	22	12,0	9,0	02522080
BSP 1/2	14	19,0	125	25	16,0	12,0	02522100
BSP 5/8	14	21,0	125	25	18,0	14,5	02522120
BSP 3/4	14	24,5	140	28	20,0	16,0	02522130
BSP 7/8	14	28,3	150	28	22,0	18,0	02522140
BSP 1	11	30,5	160	30	25,0	20,0	02522150



синее кольцо

DIN - Норма	371 / 376	371 / 376	371 / 376	371 / 376	371 / 376	371 / 376	371 / 376	371 / 376
Покрытие		TiN	VAP	PM-TiAlN		TiN	VAP	PM-TiAlN
Вид резбы	M	M	M	M	M	M	M	M
Форма заборной части	B	B	B	B	C/RSP 35°	C/RSP 35°	C/RSP 35°	C/RSP 35°
Вид отверстия	Сквозное	Сквозное	Сквозное	Сквозное	Глухое	Глухое	Глухое	Глухое
1 Улучшенные стали с прочностью до 1100 Н/мм ²	1.1 Закалённые и азотированные стали	★	★★	★	★★	★★	★★	★
	1.2 Улучшенные стали							★
	1.3 Инструментальные стали				★		★★	
2 Нержавеющие и жаропрочные стали	2.1 с прочностью 450 – 800 Н/мм ²	★★	★★	★	★★	★★	★★	★
	2.2 с прочностью 600 – 1000 Н/мм ²	★★	★★	★	★★	★★	★★	★
3 Чугун	3.1 Серый чугун							
	3.2 Высокопрочный и ковкий чугун	★				★	★★	
4 Алюминий								
5 Алюминевый сплав с содержанием Si > 10%								
6 Медь	★	★★		★★	★	★★		★★
7 Сплавы меди	★	★★		★★	★	★★		★★

красное кольцо жёлтое кольцо белое кольцо

DIN - Норма	371 / 376	371 / 376	371 / 376	371 / 376	371 / 376	371 / 376	371 / 376	371 / 376
Покрытие		TiCN		TiCN				TiCN
Вид резбы	M	M	M	M	M	M	M	M
Форма заборной части	B	B	C/RSP 40°	C/RSP 40°	B	C/RSP 45°	C/E	C/E
Вид отверстия	Сквозное	Сквозное	Глухое	Глухое	Сквозное	Глухое	Глухое / сквозное	Глухое / сквозное
1 Улучшенные стали с прочностью до 1100 Н/мм ²	1.1 Закалённые и азотированные стали	★★	★★	★	★			
	1.2 Улучшенные стали	★	★★	★	★★			
	1.3 Инструментальные стали	★	★★	★	★			
2 Нержавеющие и жаропрочные стали	2.1 с прочностью 450 – 800 Н/мм ²							
	2.2 с прочностью 600 – 1000 Н/мм ²							
3 Чугун	3.1 Серый чугун						★	★★
	3.2 Высокопрочный и ковкий чугун	★	★	★	★			
4 Алюминий					★★	★★		
5 Алюминевый сплав с содержанием Si > 10%	★	★★	★★	★★			★	★
6 Медь								
7 Сплавы меди								

★★ Оптимально подходит
 ★ Подходит
 Красное кольцо 1100 Н/мм²
 Синее кольцо INOX
 Жёлтое кольцо Алюминий
 Белое кольцо Серый чугун

Формы заборных частей:
 B 3,5 – 5 витков, с винтовой подточкой
 C 2 – 3 витка
 C/RSP 2 – 3 витка со спиральной канавкой
 E 1 – 1,5 витка



Угол реза подбирается под механические свойства обрабатываемого материала. По этой причине отдельные материалы были организованы в группы, которые имеют такие же или аналогичные механические свойства.

▶ МАШИННЫЕ МЕТЧИКИ С ЦВЕТНЫМИ КОЛЬЦАМИ DIN 371 / 376

Для простого подбора метчиков к отдельным материалам нами был создан ряд метчиков с цветной маркировкой. Мы решили использовать следующую систему подбора (таблица справа).

ГРУППЫ МАТЕРИАЛОВ

ТИП МАТЕРИАЛА	ПРЕДЕЛ ПРОЧНОСТИ	СОКР.	ЦВЕТ	УГОЛ РЕЗА
нержавеющие стали	700 – 1100	VA	голубой	8 – 10
улучшенные и инструментальные стали	600 – 1200	VG	красный	10 – 12
мягкий алюминий	100 – 600	Alu	жёлтый	20 – 25
чугун		GG	белый	3 – 5

Стали с пределом прочности в диапазоне 400-900 Н/мм² можно обрабатывать машинными метчиками из стандартной программы. Возможно изготовление резьбонарезного инструмента для специального применения или же по чертежам заказчика.

УГОЛ РЕЗА

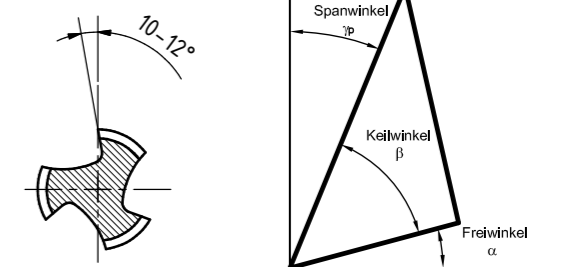

МАШИННЫЙ МЕТЧИК

ТЕХНИЧЕСКАЯ ИНФОРМАЦИЯ



Норма	DIN 371 (DIN 2184-1)	Вид отверстия	сквозное (L>1,5×d1)
Резьба	M	Направление	правый
Материал	HSS-E	Класс точности	6h
Форма	Форма В		

Синее кольцо-INOX / Машинный метчик с утолщённым хвостовиком / 3,5 – 6 Витков резьбы

Иконка	М	Н	Н	М	М	Н	Арт.-Нр.
	0,5	2,5	56	9	3,5	2,7	01029130
	0,6	2,9	56	11	4	3	01029140
	0,7	3,3	63	12	4,5	3,4	01029150
	0,8	4,2	70	16	6,0	4,9	01029170
	1,0	5,0	80	15	6,0	4,9	01029190
	1,25	6,8	90	18	8,0	6,2	01029210
	1,5	8,5	100	20	10,0	8,0	01029230

МАШИННЫЙ МЕТЧИК

ТЕХНИЧЕСКАЯ ИНФОРМАЦИЯ



Норма	DIN 376	Вид отверстия	сквозное (L>1,5×d1)
Резьба	M	Направление	правый
Материал	HSS-E	Класс точности	6h
Форма	Форма В		

Синее кольцо-INOX / Машинный метчик с проходным хвостовиком / 3,5 – 6 Витков резьбы

Иконка	М	Н	Н	М	М	Н	Арт.-Нр.
	1,75	10,2	110	23	9	7	01030250
	2,0	12,0	110	25	11	9	01030260
	2,0	14,0	110	25	12	9	01030270
	2,5	15,5	125	30	14	11	01030280
	2,5	17,5	140	30	16	12	01030290
	2,5	19,5	140	30	18	14,5	01030300
	3,0	21,0	160	36	18	14,5	01030310
	3,0	24,0	160	36	20	16	01030320
	3,5	26,5	180	40	22	18	01030330
	3,5	29,5	180	42	25	20	01030340
	4,0	32,0	200	50	28	22	01030350

МАШИННЫЙ МЕТЧИК

ТЕХНИЧЕСКАЯ ИНФОРМАЦИЯ



Норма	DIN 371 (DIN 2184-1)	Вид отверстия	сквозное (L>1,5×d1)
Резьба	M	Направление	правый
Материал	HSS-E TiN	Класс точности	6h
Форма	Форма В		

Синее кольцо-INOX / Машинный метчик с утолщённым хвостовиком / 3,5 – 6 Витков резьбы

Иконка	М	Н	Н	М	М	Н	Арт.-Нр.
	0,5	2,5	56	9	3,5	2,7	01031130
	0,6	2,9	56	11	4	3	01031140
	0,7	3,3	63	12	4,5	3,4	01031150
	0,8	4,2	70	16	6,0	4,9	01031170
	1,0	5,0	80	15	6,0	4,9	01031190
	1,25	6,8	90	18	8,0	6,2	01031210
	1,5	8,5	100	20	10,0	8,0	01031230

МАШИННЫЙ МЕТЧИК

ТЕХНИЧЕСКАЯ ИНФОРМАЦИЯ



Норма	DIN 376	Вид отверстия	сквозное (L>1,5×d1)
Резьба	M	Направление	правый
Материал	HSS-E TiN	Класс точности	6h
Форма	Форма В		

Синее кольцо-INOX / Машинный метчик с проходным хвостовиком / 3,5 – 6 Витков резьбы

Иконка	М	Н	Н	М	М	Н	Арт.-Нр.
	1,75	10,2	110	23	9	7	01032250
	2,0	12,0	110	25	11	9	01032260
	2,0	14,0	110	25	12	9	01032270
	2,5	15,5	125	30	14	11	01032280
	2,5	17,5	140	30	16	12	01032290
	2,5	19,5	140	30	18	14,5	01032300
	3,0	21,0	160	36	18	14,5	01032310
	3,0	24,0	160	36	20	16	01032320
	3,5	26,5	180	40	22	18	01032330
	3,5	29,5	180	42	25	20	01032340
	4,0	32,0	200	50	28	22	01032350

МАШИННЫЙ МЕТЧИК

ТЕХНИЧЕСКАЯ ИНФОРМАЦИЯ



Норма	DIN 371 (DIN 2184-1)	Вид отверстия	сквозное (L>1,5×d1)
Резьба	M	Направление	правый
Материал	HSS-E VAP	Класс точности	6h
Форма	Форма В		

Синее кольцо-INOX / Машинный метчик с утолщённым хвостовиком / 3,5 – 6 Витков резьбы

М	0,5	2,5	56	9	3,5	2,7	Арт.-Нр.
M 3	0,5	2,5	56	9	3,5	2,7	01033130
M 3,5	0,6	2,9	56	11	4	3	01033140
M 4	0,7	3,3	63	12	4,5	3,4	01033150
M 5	0,8	4,2	70	16	6,0	4,9	01033170
M 6	1,0	5,0	80	15	6,0	4,9	01033190
M 8	1,25	6,8	90	18	8,0	6,2	01033210
M 10	1,5	8,5	100	20	10,0	8,0	01033230

МАШИННЫЙ МЕТЧИК

ТЕХНИЧЕСКАЯ ИНФОРМАЦИЯ



Норма	DIN 376	Вид отверстия	сквозное (L>1,5×d1)
Резьба	M	Направление	правый
Материал	HSS-E VAP	Класс точности	6h
Форма	Форма В		

Синее кольцо-INOX / Машинный метчик с проходным хвостовиком / 3,5 – 6 Витков резьбы

М	1,75	10,2	110	23	9	7	Арт.-Нр.
M 12	1,75	10,2	110	23	9	7	01034250
M 14	2,0	12,0	110	25	11	9	01034260
M 16	2,0	14,0	110	25	12	9	01034270
M 18	2,5	15,5	125	30	14	11	01034280
M 20	2,5	17,5	140	30	16	12	01034290
M 22	2,5	19,5	140	30	18	14,5	01034300
M 24	3,0	21,0	160	36	18	14,5	01034310
M 27	3,0	24,0	160	36	20	16	01034320
M 30	3,5	26,5	180	40	22	18	01034330
M 33	3,5	29,5	180	42	25	20	01034340
M 36	4,0	32,0	200	50	28	22	01034350

МАШИННЫЙ МЕТЧИК

ТЕХНИЧЕСКАЯ ИНФОРМАЦИЯ



Норма	DIN 371 (DIN 2184-1)	Вид отверстия	сквозное (L>1,5×d1)
Резьба	M	Направление	правый
Материал	HSSE-PM TiAlN	Класс точности	6h
Форма	Форма В		

Синее кольцо-INOX / Машинный метчик с утолщённым хвостовиком / 3,5 – 6 Витков резьбы

М	0,5	2,5	56	9	3,5	2,7	Арт.-Нр.
M 3	0,5	2,5	56	9	3,5	2,7	01035130
M 3,5	0,6	2,9	56	11	4	3	01035140
M 4	0,7	3,3	63	12	4,5	3,4	01035150
M 5	0,8	4,2	70	16	6,0	4,9	01035170
M 6	1,0	5,0	80	15	6,0	4,9	01035190
M 8	1,25	6,8	90	18	8,0	6,2	01035210
M 10	1,5	8,5	100	20	10,0	8,0	01035230

МАШИННЫЙ МЕТЧИК

ТЕХНИЧЕСКАЯ ИНФОРМАЦИЯ



Норма	DIN 376	Вид отверстия	сквозное (L>1,5×d1)
Резьба	M	Направление	правый
Материал	HSSE-PM TiAlN	Класс точности	6h
Форма	Форма В		

Синее кольцо-INOX / Машинный метчик с проходным хвостовиком / 3,5 – 6 Витков резьбы

М	1,75	10,2	110	23	9	7,0	Арт.-Нр.
M 12	1,75	10,2	110	23	9	7,0	01036250

МАШИННЫЙ МЕТЧИК

ТЕХНИЧЕСКАЯ ИНФОРМАЦИЯ



Норма	DIN 371 (DIN 2184-1)	Вид отверстия	глухое (L<2d1)
Резьба	M	Направление	правый
Материал	HSS-E	Класс точности	6h
Форма	Форма C/RSP 35°		

Синее кольцо-INOX / Машинный метчик с утолщённым хвостовиком / 2 – 3 Витков резьбы

М	0,5	2,5	56	5	3,5	2,7	Арт.-Нр.
M 3	0,5	2,5	56	5	3,5	2,7	01037130
M 3,5	0,6	2,9	56	6	4	3	01037140
M 4	0,7	3,3	63	7	4,5	3,4	01037150
M 5	0,8	4,2	70	8	6	4,9	01037170
M 6	1,0	5,0	80	10	6	4,9	01037190
M 8	1,25	6,8	90	13	8	6,2	01037210
M 10	1,5	8,5	100	15	10	8	01037230

МАШИННЫЙ МЕТЧИК

ТЕХНИЧЕСКАЯ ИНФОРМАЦИЯ



Норма	DIN 376	Вид отверстия	глухое (L<2d1)
Резьба	M	Направление	правый
Материал	HSS-E	Класс точности	6h
Форма	Форма C/RSP 35°		

Синее кольцо-INOX / Машинный метчик с проходным хвостовиком / 2 – 3 Витков резьбы

М	1,75	10,2	110	18	9	7	Арт.-Нр.
M 12	1,75	10,2	110	18	9	7	01038250
M 14	2,0	12,0	110	20	11	9	01038260
M 16	2,0	14,0	110	20	12	9	01038270
M 18	2,5	15,5	125	25	14	11	01038280
M 20	2,5	17,5	140	25	16	12	01038290
M 22	2,5	19,5	140	25	18	14,5	01038300
M 24	3,0	21,0	160	30	18	14,5	01038310
M 27	3,0	24,0	160	30	20	16	01038320
M 30	3,5	26,5	180	35	22	18	01038330
M 33	3,5	29,5	180	35	25	20	01038340
M 36	4,0	32,0	200	40	28	22	01038350

МАШИННЫЙ МЕТЧИК

ТЕХНИЧЕСКАЯ ИНФОРМАЦИЯ



Норма	DIN 371 (DIN 2184-1)	Вид отверстия	глухое (L<2d1)
Резьба	M	Направление	правый
Материал	HSS-E TiN	Класс точности	6h
Форма	Форма C/RSP 35°		

Синее кольцо-INOX / Машинный метчик с утолщённым хвостовиком / 2 – 3 Витков резьбы

М	0,5	2,5	56	5	3,5	2,7	Арт.-Нр.
M 3	0,5	2,5	56	5	3,5	2,7	01039130
M 3,5	0,6	2,9	56	6	4	3	01039140
M 4	0,7	3,3	63	7	4,5	3,4	01039150
M 5	0,8	4,2	70	8	6	4,9	01039170
M 6	1,0	5,0	80	10	6	4,9	01039190
M 8	1,25	6,8	90	13	8	6,2	01039210
M 10	1,5	8,5	100	15	10	8	01039230

МАШИННЫЙ МЕТЧИК

ТЕХНИЧЕСКАЯ ИНФОРМАЦИЯ



Норма	DIN 376	Вид отверстия	глухое (L<2d1)
Резьба	M	Направление	правый
Материал	HSS-E TiN	Класс точности	6h
Форма	Форма C/RSP 35°		

Синее кольцо-INOX / Машинный метчик с проходным хвостовиком / 2 – 3 Витков резьбы

М	1,75	10,2	110	18	9	7	Арт.-Нр.
M 12	1,75	10,2	110	18	9	7	01040250
M 14	2,0	12,0	110	20	11	9	01040260
M 16	2,0	14,0	110	20	12	9	01040270
M 18	2,5	15,5	125	25	14	11	01040280
M 20	2,5	17,5	140	25	16	12	01040290
M 22	2,5	19,5	140	25	18	14,5	01040300
M 24	3,0	21,0	160	30	18	14,5	01040310
M 27	3,0	24,0	160	30	20	16	01040320
M 30	3,5	26,5	180	35	22	18	01040330
M 33	3,5	29,5	180	35	25	20	01040340
M 36	4,0	32,0	200	40	28	22	01040350

МАШИННЫЙ МЕТЧИК

ТЕХНИЧЕСКАЯ ИНФОРМАЦИЯ



Норма	DIN 371 (DIN 2184-1)	Вид отверстия	глухое (L<2d1)
Резьба	M	Направление	правый
Материал	HSS-E VAP	Класс точности	6h
Форма	Форма C/RSP 35°		

Синее кольцо-INOX / Машинный метчик с утолщённым хвостовиком / 2 – 3 Витков резьбы

М	0,5	2,5	56	5	3,5	2,7	Арт.-Нр.
M 3	0,5	2,5	56	5	3,5	2,7	01041130
M 3,5	0,6	2,9	56	6	4	3	01041140
M 4	0,7	3,3	63	7	4,5	3,4	01041150
M 5	0,8	4,2	70	8	6	4,9	01041170
M 6	1,0	5,0	80	10	6	4,9	01041190
M 8	1,25	6,8	90	13	8	6,2	01041210
M 10	1,5	8,5	100	15	10	8	01041230

МАШИННЫЙ МЕТЧИК

ТЕХНИЧЕСКАЯ ИНФОРМАЦИЯ



Норма	DIN 376	Вид отверстия	глухое (L<2d1)
Резьба	M	Направление	правый
Материал	HSS-E VAP	Класс точности	6h
Форма	Форма C/RSP 35°		

Синее кольцо-INOX / Машинный метчик с проходным хвостовиком / 2 – 3 Витков резьбы

М	1,75	10,2	110	18	9	7	Арт.-Нр.
M 12	1,75	10,2	110	18	9	7	01042250
M 14	2,0	12,0	110	20	11	9	01042260
M 16	2,0	14,0	110	20	12	9	01042270
M 18	2,5	15,5	125	25	14	11	01042280
M 20	2,5	17,5	140	25	16	12	01042290
M 22	2,5	19,5	140	25	18	14,5	01042300
M 24	3,0	21,0	160	30	18	14,5	01042310
M 27	3,0	24,0	160	30	20	16	01042320
M 30	3,5	26,5	180	35	22	18	01042330
M 33	3,5	29,5	180	35	25	20	01042340
M 36	4,0	32,0	200	40	28	22	01042350

МАШИННЫЙ МЕТЧИК

ТЕХНИЧЕСКАЯ ИНФОРМАЦИЯ



Норма	DIN 371 (DIN 2184-1)	Вид отверстия	глухое (L<2d1)
Резьба	M	Направление	правый
Материал	HSSE-PM TiAlN	Класс точности	6h
Форма	Форма C/RSP 35°		

Синее кольцо-INOX / Машинный метчик с утолщённым хвостовиком / 2 – 3 Витков резьбы

М	0,5	2,5	56	5	3,5	2,7	Арт.-Нр.
M 3	0,5	2,5	56	5	3,5	2,7	01043130
M 3,5	0,6	2,9	56	6	4	3	01043140
M 4	0,7	3,3	63	7	4,5	3,4	01043150
M 5	0,8	4,2	70	8	6	4,9	01043170
M 6	1,0	5,0	80	10	6	4,9	01043190
M 8	1,25	6,8	90	13	8	6,2	01043210
M 10	1,5	8,5	100	15	10	8	01043230

МАШИННЫЙ МЕТЧИК

ТЕХНИЧЕСКАЯ ИНФОРМАЦИЯ



Норма	DIN 376	Вид отверстия	глухое (L<2d1)
Резьба	M	Направление	правый
Материал	HSSE-PM TiAlN	Класс точности	6h
Форма	Форма C/RSP 35°		

Синее кольцо-INOX / Машинный метчик с проходным хвостовиком / 2 – 3 Витков резьбы

М	1,75	10,2	110	18	9	7	Арт.-Нр.
M 12	1,75	10,2	110	18	9	7	01044250

МАШИННЫЙ МЕТЧИК

ТЕХНИЧЕСКАЯ ИНФОРМАЦИЯ



Норма	DIN 371 (DIN 2184-1)	Вид отверстия	сквозное (L>1,5×d1)
Резьба	M	Направление	правый
Материал	HSS-E V3	Класс точности	6h
Форма	Форма В		

Красное кольцо-1200 N/мм² / Машинный метчик с утолщённым хвостовиком / 3,5 – 6 Витков резьбы

М	0,5	2,5	56	9	3,5	2,7	Арт.-Нр.
M 3	0,5	2,5	56	9	3,5	2,7	01045130
M 3,5	0,6	2,9	56	11	4	3	01045140
M 4	0,7	3,3	63	12	4,5	3,4	01045150
M 5	0,8	4,2	70	16	6,0	4,9	01045170
M 6	1,0	5,0	80	15	6,0	4,9	01045190
M 8	1,25	6,8	90	18	8,0	6,2	01045210
M 10	1,5	8,5	100	20	10,0	8,0	01045230

МАШИННЫЙ МЕТЧИК

ТЕХНИЧЕСКАЯ ИНФОРМАЦИЯ



Норма	DIN 376	Вид отверстия	сквозное (L>1,5×d1)
Резьба	M	Направление	правый
Материал	HSS-E V3	Класс точности	6h
Форма	Форма В		

Красное кольцо-1200 N/мм² / Машинный метчик с проходным хвостовиком / 3,5 – 6 Витков резьбы

М	1,75	10,2	110	23	9	7	Арт.-Нр.
M 12	1,75	10,2	110	23	9	7	01046250
M 14	2,0	12,0	110	25	11	9	01046260
M 16	2,0	14,0	110	25	12	9	01046270
M 18	2,5	15,5	125	30	14	11	01046280
M 20	2,5	17,5	140	30	16	12	01046290
M 22	2,5	19,5	140	30	18	14,5	01046300
M 24	3,0	21,0	160	36	18	14,5	01046310
M 27	3,0	24,0	160	36	20	16	01046320
M 30	3,5	26,5	180	40	22	18	01046330
M 33	3,5	29,5	180	42	25	20	01046340
M 36	4,0	32,0	200	50	28	22	01046350

МАШИННЫЙ МЕТЧИК

ТЕХНИЧЕСКАЯ ИНФОРМАЦИЯ



Норма	DIN 371 (DIN 2184-1)	Вид отверстия	сквозное (L>1,5×d1)
Резьба	M	Направление	правый
Материал	HSS-E V3 TiCN	Класс точности	6h
Форма	Форма В		

Красное кольцо-1200 N/мм² / Машинный метчик с утолщённым хвостовиком / 3,5 – 6 Витков резьбы

М	0,5	2,5	56	9	3,5	2,7	Арт.-Нр.
M 3	0,5	2,5	56	9	3,5	2,7	01047130
M 3,5	0,6	2,9	56	11	4	3	01047140
M 4	0,7	3,3	63	12	4,5	3,4	01047150
M 5	0,8	4,2	70	16	6,0	4,9	01047170
M 6	1,0	5,0	80	15	6,0	4,9	01047190
M 8	1,25	6,8	90	18	8,0	6,2	01047210
M 10	1,5	8,5	100	20	10,0	8,0	01047230

МАШИННЫЙ МЕТЧИК

ТЕХНИЧЕСКАЯ ИНФОРМАЦИЯ



Норма	DIN 376	Вид отверстия	сквозное (L>1,5×d1)
Резьба	M	Направление	правый
Материал	HSS-E V3 TiCN	Класс точности	6h
Форма	Форма В		

Красное кольцо-1200 N/мм² / Машинный метчик с проходным хвостовиком / 3,5 – 6 Витков резьбы

М	1,75	10,2	110	23	9	7	Арт.-Нр.
M 12	1,75	10,2	110	23	9	7	01048250
M 14	2,0	12,0	110	25	11	9	01048260
M 16	2,0	14,0	110	25	12	9	01048270
M 18	2,5	15,5	125	30	14	11	01048280
M 20	2,5	17,5	140	30	16	12	01048290
M 22	2,5	19,5	140	30	18	14,5	01048300
M 24	3,0	21,0	160	36	18	14,5	01048310
M 27	3,0	24,0	160	36	20	16	01048320
M 30	3,5	26,5	180	40	22	18	01048330
M 33	3,5	29,5	180	42	25	20	01048340
M 36	4,0	32,0	200	50	28	22	01048350

МАШИННЫЙ МЕТЧИК



ТЕХНИЧЕСКАЯ ИНФОРМАЦИЯ

Норма	DIN 371 (DIN 2184-1)	Вид отверстия	глухое (L<2d1)
Резьба	M	Направление	правый
Материал	HSS-E V3	Класс точности	6h
Форма	Форма C/RSP 40°		

Красное кольцо-1200 N/мм² / Машинный метчик с утолщённым хвостовиком / 2 – 3 Витков резьбы

М	0,5	2,5	56	5	3,5	2,7	Арт.-Нр.
M 3	0,5	2,5	56	5	3,5	2,7	01049130
M 3,5	0,6	2,9	56	6	4	3	01049140
M 4	0,7	3,3	63	7	4,5	3,4	01049150
M 5	0,8	4,2	70	8	6	4,9	01049170
M 6	1,0	5,0	80	10	6	4,9	01049190
M 8	1,25	6,8	90	13	8	6,2	01049210
M 10	1,5	8,5	100	15	10	8	01049230

МАШИННЫЙ МЕТЧИК



ТЕХНИЧЕСКАЯ ИНФОРМАЦИЯ

Норма	DIN 376	Вид отверстия	глухое (L<2d1)
Резьба	M	Направление	правый
Материал	HSS-E V3	Класс точности	6h
Форма	Форма C/RSP 40°		

Красное кольцо-1200 N/мм² / Машинный метчик с проходным хвостовиком / 2 – 3 Витков резьбы

М	1,75	10,2	110	18	9	7	Арт.-Нр.
M 12	1,75	10,2	110	18	9	7	01050250
M 14	2,0	12,0	110	20	11	9	01050260
M 16	2,0	14,0	110	20	12	9	01050270
M 18	2,5	15,5	125	25	14	11	01050280
M 20	2,5	17,5	140	25	16	12	01050290
M 22	2,5	19,5	140	25	18	14,5	01050300
M 24	3,0	21,0	160	30	18	14,5	01050310
M 27	3,0	24,0	160	30	20	16	01050320
M 30	3,5	26,5	180	35	22	18	01050330
M 33	3,5	29,5	180	35	25	20	01050340
M 36	4,0	32,0	200	40	28	22	01050350

МАШИННЫЙ МЕТЧИК



ТЕХНИЧЕСКАЯ ИНФОРМАЦИЯ

Норма	DIN 371 (DIN 2184-1)	Вид отверстия	глухое (L<2d1)
Резьба	M	Направление	правый
Материал	HSS-E V3 TiCN	Класс точности	6h
Форма	Форма C/RSP 40°		

Красное кольцо-1200 N/мм² / Машинный метчик с утолщённым хвостовиком / 2 – 3 Витков резьбы

М	0,5	2,5	56	5	3,5	2,7	Арт.-Нр.
M 3	0,5	2,5	56	5	3,5	2,7	01051130
M 3,5	0,6	2,9	56	6	4	3	01051140
M 4	0,7	3,3	63	7	4,5	3,4	01051150
M 5	0,8	4,2	70	8	6	4,9	01051170
M 6	1,0	5,0	80	10	6	4,9	01051190
M 8	1,25	6,8	90	13	8	6,2	01051210
M 10	1,5	8,5	100	15	10	8	01051230

МАШИННЫЙ МЕТЧИК



ТЕХНИЧЕСКАЯ ИНФОРМАЦИЯ

Норма	DIN 371 (DIN 2184-1)	Вид отверстия	глухое (L<2d1)
Резьба	M	Направление	правый
Материал	HSS-E V3 TiCN	Класс точности	6h
Форма	Форма C/RSP 40°		

Красное кольцо-1200 N/мм² / Машинный метчик с проходным хвостовиком / 2 – 3 Витков резьбы

М	1,75	10,2	110	18	9	7	Арт.-Нр.
M 12	1,75	10,2	110	18	9	7	01052250
M 14	2,0	12,0	110	20	11	9	01052260
M 16	2,0	14,0	110	20	12	9	01052270
M 18	2,5	15,5	125	25	14	11	01052280
M 20	2,5	17,5	140	25	16	12	01052290
M 22	2,5	19,5	140	25	18	14,5	01052300
M 24	3,0	21,0	160	30	18	14,5	01052310
M 27	3,0	24,0	160	30	20	16	01052320
M 30	3,5	26,5	180	35	22	18	01052330
M 33	3,5	29,5	180	35	25	20	01052340
M 36	4,0	32,0	200	40	28	22	01052350

МАШИННЫЙ МЕТЧИК

ТЕХНИЧЕСКАЯ ИНФОРМАЦИЯ



Норма	DIN 371 (DIN 2184-1)	Вид отверстия	сквозное (L>1,5×d1)
Резьба	M	Направление	правый
Материал	HSS-E	Класс точности	6h
Форма	Форма В		

Жёлтое кольцо-ALU / Машинный метчик с утолщённым хвостовиком / 3,5 – 6 Витков резьбы

М	0,5	2,5	56	9	3,5	2,7	Арт.-Нр.
М 3	0,5	2,5	56	9	3,5	2,7	01053130
М 3,5	0,6	2,9	56	11	4	3	01053140
М 4	0,7	3,3	63	12	4,5	3,4	01053150
М 5	0,8	4,2	70	16	6,0	4,9	01053170
М 6	1,0	5,0	80	15	6,0	4,9	01053190
М 8	1,25	6,8	90	18	8,0	6,2	01053210
М 10	1,5	8,5	100	20	10,0	8,0	01053230

МАШИННЫЙ МЕТЧИК

ТЕХНИЧЕСКАЯ ИНФОРМАЦИЯ



Норма	DIN 376	Вид отверстия	сквозное (L>1,5×d1)
Резьба	M	Направление	правый
Материал	HSS-E	Класс точности	6h
Форма	Форма В		

Жёлтое кольцо-ALU / Машинный метчик с проходным хвостовиком / 3,5 – 6 Витков резьбы

М	1,75	10,2	110	23	9	7	Арт.-Нр.
М 12	1,75	10,2	110	23	9	7	01054250
М 14	2,0	12,0	110	25	11	9	01054260
М 16	2,0	14,0	110	25	12	9	01054270
М 18	2,5	15,5	125	30	14	11	01054280
М 20	2,5	17,5	140	30	16	12	01054290
М 22	2,5	19,5	140	30	18	14,5	01054300
М 24	3,0	21,0	160	36	18	14,5	01054310
М 27	3,0	24,0	160	36	20	16	01054320
М 30	3,5	26,5	180	40	22	18	01054330
М 33	3,5	29,5	180	42	25	20	01054340
М 36	4,0	32,0	200	50	28	22	01054350

МАШИННЫЙ МЕТЧИК

ТЕХНИЧЕСКАЯ ИНФОРМАЦИЯ



Норма	DIN 371 (DIN 2184-1)	Вид отверстия	глухое (L<2d1)
Резьба	M	Направление	правый
Материал	HSS-E	Класс точности	6h
Форма	Форма C/RSP 45°		

Жёлтое кольцо-ALU / Машинный метчик с утолщённым хвостовиком / 2 – 3 Витков резьбы

М	0,5	2,5	56	5	3,5	2,7	Арт.-Нр.
М 3	0,5	2,5	56	5	3,5	2,7	01055130
М 3,5	0,6	2,9	56	6	4	3	01055140
М 4	0,7	3,3	63	7	4,5	3,4	01055150
М 5	0,8	4,2	70	8	6	4,9	01055170
М 6	1,0	5,0	80	10	6	4,9	01055190
М 8	1,25	6,8	90	13	8	6,2	01055210
М 10	1,5	8,5	100	15	10	8	01055230

МАШИННЫЙ МЕТЧИК

ТЕХНИЧЕСКАЯ ИНФОРМАЦИЯ



Норма	DIN 371 (DIN 2184-1)	Вид отверстия	глухое (L<2d1)
Резьба	M	Направление	правый
Материал	HSS-E	Класс точности	6h
Форма	Форма C/RSP 45°		

Жёлтое кольцо-ALU / Машинный метчик с проходным хвостовиком / 2 – 3 Витков резьбы

М	1,75	10,2	110	18	9	7	Арт.-Нр.
М 12	1,75	10,2	110	18	9	7	01056250
М 14	2,0	12,0	110	20	11	9	01056260
М 16	2,0	14,0	110	20	12	9	01056270
М 18	2,5	15,5	125	25	14	11	01056280
М 20	2,5	17,5	140	25	16	12	01056290
М 22	2,5	19,5	140	25	18	14,5	01056300
М 24	3,0	21,0	160	30	18	14,5	01056310
М 27	3,0	24,0	160	30	20	16	01056320
М 30	3,5	26,5	180	35	22	18	01056330
М 33	3,5	29,5	180	35	25	20	01056340
М 36	4,0	32,0	200	40	28	22	01056350

МАШИННЫЙ МЕТЧИК

ТЕХНИЧЕСКАЯ ИНФОРМАЦИЯ



Норма	DIN 371 (DIN 2184-1)	Вид отверстия	глухое (L<2,5d1) / сквозное (L>1,5×d1)
Резьба	M	Направление	правый
Материал	HSS-E	Класс точности	6НХ
Форма	Форма С		

Белое кольцо-GG / Машинный метчик с утолщённым хвостовиком / 2 – 3 Витков резьбы

М	0,5	2,5	56	9	3,5	2,7	Арт.-Нр.
M 3	0,5	2,5	56	9	3,5	2,7	01057130
M 3,5	0,6	2,9	56	10	4	3	01057140
M 4	0,7	3,3	63	12	4,5	3,4	01057150
M 5	0,8	4,2	70	13	6	4,9	01057170
M 6	1,0	5,0	80	15	6	4,9	01057190
M 8	1,25	6,8	90	18	8	6,2	01057210
M 10	1,5	8,5	100	20	10	8	01057230

МАШИННЫЙ МЕТЧИК

ТЕХНИЧЕСКАЯ ИНФОРМАЦИЯ



Норма	DIN 376	Вид отверстия	глухое (L<2,5d1) / сквозное (L>1,5×d1)
Резьба	M	Направление	правый
Материал	HSS-E	Класс точности	6НХ
Форма	Форма С		

Белое кольцо-GG / Машинный метчик с проходным хвостовиком / 2 – 3 Витков резьбы

М	1,75	10,2	110	23	9	7	Арт.-Нр.
M 12	1,75	10,2	110	23	9	7	01058250
M 14	2,0	12,0	110	25	11	9	01058260
M 16	2,0	14,0	110	25	12	9	01058270
M 18	2,5	15,5	125	30	14	11	01058280
M 20	2,5	17,5	140	30	16	12	01058290
M 22	2,5	19,5	140	30	18	14,5	01058300
M 24	3,0	21,0	160	36	18	14,5	01058310
M 27	3,0	24,0	160	36	20	16	01058320
M 30	3,5	26,5	180	40	22	18	01058330
M 33	3,5	29,5	180	42	25	20	01058340
M 36	4,0	32,0	200	50	28	22	01058350

МАШИННЫЙ МЕТЧИК

ТЕХНИЧЕСКАЯ ИНФОРМАЦИЯ



Норма	DIN 371 (DIN 2184-1)	Вид отверстия	глухое (L<2,5d1) / сквозное (L>1,5×d1)
Резьба	M	Направление	правый
Материал	HSS-E TiCN	Класс точности	6НХ
Форма	Форма С		

Белое кольцо-GG / Машинный метчик с утолщённым хвостовиком / 2 – 3 Витков резьбы

М	0,5	2,5	56	9	3,5	2,7	Арт.-Нр.
M 3	0,5	2,5	56	9	3,5	2,7	01059130
M 3,5	0,6	2,9	56	10	4	3	01059140
M 4	0,7	3,3	63	12	4,5	3,4	01059150
M 5	0,8	4,2	70	13	6	4,9	01059170
M 6	1,0	5,0	80	15	6	4,9	01059190
M 8	1,25	6,8	90	18	8	6,2	01059210
M 10	1,5	8,5	100	20	10	8	01059230

МАШИННЫЙ МЕТЧИК

ТЕХНИЧЕСКАЯ ИНФОРМАЦИЯ



Норма	DIN 376	Вид отверстия	глухое (L<2,5d1) / сквозное (L>1,5×d1)
Резьба	M	Направление	правый
Материал	HSS-E TiCN	Класс точности	6НХ
Форма	Форма С		

Белое кольцо-GG / Машинный метчик с проходным хвостовиком / 2 – 3 Витков резьбы

М	1,75	10,2	110	23	9	7	Арт.-Нр.
M 12	1,75	10,2	110	23	9	7	01060250
M 14	2,0	12,0	110	25	11	9	01060260
M 16	2,0	14,0	110	25	12	9	01060270
M 18	2,5	15,5	125	30	14	11	01060280
M 20	2,5	17,5	140	30	16	12	01060290
M 22	2,5	19,5	140	30	18	14,5	01060300
M 24	3,0	21,0	160	36	18	14,5	01060310
M 27	3,0	24,0	160	36	20	16	01060320
M 30	3,5	26,5	180	40	22	18	01060330
M 33	3,5	29,5	180	42	25	20	01060340
M 36	4,0	32,0	200	50	28	22	01060350

НАКЛЁП

Наклёп означает деформирование металлов при температуре ниже температуры рекристаллизации, что приводит к увеличению плотности и твёрдости и снижению пластичности, вязкости. При перенаклёпе в материале образуются поры.



▶ БЕССТРУЖЕЧНЫЕ МЕТЧИКИ

НАЖИМНЫЕ КРАЯ

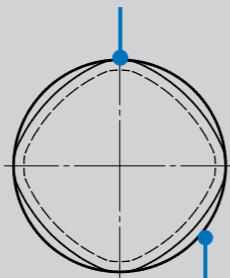
ПОЛИГОНАЛЬНАЯ
ФОРМАa = ДИАМЕТР
ОТВЕРСТИЯb = ДИАМЕТР
РЕЗЬБЫ

КАНАВКА

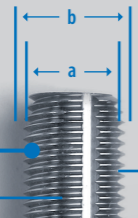
ВХОДЯЩАЯ
ЧАСТЬКАЛИБРИ-
РУЩАЯ ЧАСТЬ

При помощи бесстружечных метчиков наклёпывается внутренняя резьба, но только при условии, что материал имеет свойство деформироваться. Краймя выдавливается материал и таким образом формируется резьба.

Таким способом не образуется стружка, поверхность остаётся гладкой и обработка происходит быстро. Тем не менее, класс точности у отверстия уже и прилагаемые усилия больше чем при нарезки резьбы.

ЧЕТЫРЁГРАННИК

по DIN 10

**РЕЗЬБАФОРМАЕР DIN 371****РЕЗЬБАФОРМАЕР****ТЕХНИЧЕСКАЯ ИНФОРМАЦИЯ**

Норма	DIN 371 (2184-1)	Вид отверстия	Сквозное / глухое
Резьба	M	Направление	правый
Материал	HSSE-G / TIN	Класс точности	ISO 2 / 6HX
Форма	Форма D	Обр. Материал	Сталь

Бесстружечный метчик с 4-5 витками, покрытием нитрида титана

							Арт.-Нр.
M 3	0,5	2,8	56	11	3,5	2,7	01900130
M 4	0,7	3,7	63	13	4,5	3,4	01900150
M 5	0,8	4,65	70	16	6,0	4,9	01900170
M 6	1,0	5,55	80	19	6,0	4,9	01900190
M 8	1,25	7,45	90	22	8,0	6,2	01900210
M 10	1,5	9,35	100	24	10,0	8,0	01900230

РЕЗЬБАФОРМАЕР**ТЕХНИЧЕСКАЯ ИНФОРМАЦИЯ**

Норма	DIN 371 (2184-1)	Вид отверстия	Сквозное / глухое
Резьба	M	Направление	правый
Материал	HSSE-G / VAP	Класс точности	ISO 2 / 6HX
Форма	Форма D	Обр. Материал	VA-Сталь

Бесстружечный метчик с 4-5 витками, вapoризированный

							Арт.-Нр.
M 3	0,5	2,8	56	11	3,5	2,7	01901130
M 4	0,7	3,7	63	13	4,5	3,4	01901150
M 5	0,8	4,65	70	16	6,0	4,9	01901170
M 6	1,0	5,55	80	19	6,0	4,9	01901190
M 8	1,25	7,45	90	22	8,0	6,2	01901210
M 10	1,5	9,35	100	24	10,0	8,0	01901230

Твёрдый сплав это составной материал. Он состоит из сплавленных ультра мелких частиц твёрдого металла. Как правило используется карбид вольфрама как твёрдый материал и кобальт как связующее вещество. Вид связующего вещества и размер зерна определяют свойства металла. Для метчиков мы используем сорт стали K44UF. К обозначает группу материала, UF обозначает размер зерна (в нашем случае ultrafein) и 44 является показателем износостойкости, физические свойства которого представлены ниже.

▶ ТВЁРДОСПЛАВНЫЕ МАШИННЫЕ МЕТЧИКИ



Твёрдосплавные метчики используются для обработки твёрдых материалов (до HRC 91-93), поскольку изготовленные из твёрдого сплава инструменты обладают высокой твёрдостью и износостойкостью, что приводит даже в сложных рабочих условиях к долгому сроку службы.

СВОЙСТВА – VHM

Плотность: (g/cm³): 14,05 ± 0,15
 Твёрдость HRA: 92,5
 Твёрдость HV 30: 1680
 Прочность на изгиб (N/mm²): > 4000
 Размер зерна [μ]: Ultrafein ~0,4 – 0,6

МАШИННЫЙ МЕТЧИК



Машинный метчик с утолщённым хвостовиком, 6–8 витков резьбы

ТЕХНИЧЕСКАЯ ИНФОРМАЦИЯ

Норма	DIN 371	Вид отверстия	сквозное < 1.1/2xd
Резьба	M	Направление	правый
Материал	VHM	Класс точности	6h
Форма	Форма А	Обр. Материал	Сталь

М	мм	мм	мм	мм	мм	мм	Арт.-Нр.
M 2	0,4	1,6	45	8	2,8	2,1	07014080
M 2,2	0,45	1,75	45	9	2,8	2,1	07014090
M 2,3	0,4	1,9	45	9	2,8	2,1	07014100
M 2,5	0,45	2,05	50	9	2,8	2,1	07014110
M 2,6	0,45	2,1	50	9	2,8	2,1	07014120
M 3	0,5	2,5	56	11	3,5	2,7	07014130
M 3,5	0,6	2,9	56	12	4,0	3,0	07014140
M 4	0,7	3,3	63	13	4,5	3,4	07014150
M 5	0,8	4,2	70	16	6,0	4,9	07014170
M 6	1,0	5,0	80	19	6,0	4,9	07014190
M 7	1,0	6,0	80	19	7,0	5,5	07014200
M 8	1,25	6,8	90	22	8,0	6,2	07014210
M 10	1,5	8,5	100	24	10,0	8,0	07014230

МАШИННЫЙ МЕТЧИК



Машинный метчик с проходным хвостовиком, 6–8 витков резьбы

ТЕХНИЧЕСКАЯ ИНФОРМАЦИЯ

Норма	DIN 376	Вид отверстия	сквозное < 1.1/2xd
Резьба	M	Направление	правый
Материал	VHM	Класс точности	6h
Форма	Форма А	Обр. Материал	Сталь

М	мм	мм	мм	мм	мм	мм	Арт.-Нр.
M 12	1,75	10,2	110	28	9,0	7,0	07015250
M 14	2,0	12,0	110	30	11,0	9,0	07015260
M 16	2,0	14,0	110	32	12,0	9,0	07015270
M 18	2,5	15,5	125	34	14,0	11,0	07015280
M 20	2,5	17,5	140	34	16,0	12,0	07015290
M 22	2,5	19,5	140	34	18,0	14,5	07015300
M 24	3,0	21,0	160	38	18,0	14,5	07015310
M 27	3,0	24,0	160	38	20,0	16,0	07015320
M 30	3,5	26,5	180	45	22,0	18,0	07015330
M 33	3,5	29,5	180	50	25,0	20,0	07015340
M 36	4,0	32,0	200	56	28,0	22,0	07015350

МАШИННЫЙ МЕТЧИК

ТЕХНИЧЕСКАЯ ИНФОРМАЦИЯ



Норма	DIN 371 (DIN 2184-1)	Вид отверстия	сквозное < 1.1/2xd
Резьба	M	Направление	правый
Материал	VHM	Класс точности	6h
Форма	Форма В	Обр. Материал	Сталь до 92 HRC

Машинный метчик с утолщённым хвостовиком, 4–5 витков резьбы со спиральной подточкой (стружколом)

М	мм	мм	мм	мм	мм	мм	Арт.-Нр.
M 2	0,4	1,6	45	8	2,8	2,1	07000080
M 2,2	0,45	1,75	45	9	2,8	2,1	07000090
M 2,3	0,4	1,9	45	9	2,8	2,1	07000100
M 2,5	0,45	2,05	50	9	2,8	2,1	07000110
M 2,6	0,45	2,1	50	9	2,8	2,1	07000120
M 3	0,5	2,5	56	11	3,5	2,7	07000130
M 3,5	0,6	2,9	56	12	4,0	3,0	07000140
M 4	0,7	3,3	63	13	4,5	3,4	07000150
M 5	0,8	4,2	70	16	6,0	4,9	07000170
M 6	1,0	5,0	80	19	6,0	4,9	07000190
M 7	1,0	6,0	80	19	7,0	5,5	07000200
M 8	1,25	6,8	90	22	8,0	6,2	07000210
M 10	1,5	8,5	100	24	10,0	8,0	07000230

МАШИННЫЙ МЕТЧИК

ТЕХНИЧЕСКАЯ ИНФОРМАЦИЯ



Норма	DIN 376 (DIN 2184-1)	Вид отверстия	сквозное < 1.1/2xd
Резьба	M	Направление	правый
Материал	VHM	Класс точности	6h
Форма	Форма В	Обр. Материал	Сталь до 92 HRC

Машинный метчик с проходным хвостовиком, 4–5 витков резьбы со спиральной подточкой (стружколом)

М	мм	мм	мм	мм	мм	мм	Арт.-Нр.
M 3	0,5	2,5	56	10	2,2	—	07001130
M 4	0,7	3,3	63	12	2,8	2,1	07001150
M 5	0,8	4,2	70	14	3,5	2,7	07001170
M 6	1,0	5,0	80	16	4,5	3,4	07001190
M 8	1,25	6,8	90	18	6,0	4,9	07001210
M 10	1,5	8,5	100	20	7,0	5,5	07001230
M 12	1,75	10,2	110	28	9,0	7,0	07001250
M 14	2,0	12,0	110	30	11,0	9,0	07001260
M 16	2,0	14,0	110	32	12,0	9,0	07001270
M 18	2,5	15,5	125	34	14,0	11,0	07001280
M 20	2,5	17,5	140	34	16,0	12,0	07001290
M 22	2,5	19,5	140	34	18,0	14,5	07001300
M 24	3,0	21,0	160	38	18,0	14,5	07001310
M 27	3,0	24,0	160	38	20,0	16,0	07001320
M 30	3,5	26,5	180	45	22,0	18,0	07001330
M 33	3,5	29,5	180	50	25,0	20,0	07001340
M 36	4,0	32,0	200	56	28,0	22,0	07001350
M 39	4,0	35,0	200	60	32,0	24,0	07001360
M 42	4,5	37,5	200	60	32,0	24,0	07001370
M 45	4,5	40,5	220	65	36,0	29,0	07001380
M 48	5,0	43,0	250	70	36,0	29,0	07001390
M 52	5,0	47,0	250	70	40,0	32,0	07001400
M 56	5,5	51,5	250	70	40,0	32,0	07001410
M 60	5,5	54,5	280	75	45,0	35,0	07001420
M 64	6,0	58,0	315	80	50,0	39,0	07001430
M 68	6,0	62,0	315	80	50,0	39,0	07001440
M 72	6,0	66,0	340	80	50,0	39,0	07001450
M 76	6,0	70,0	340	80	50,0	39,0	07001460
M 80	6,0	74,0	360	85	50,0	39,0	07001470
M 84	6,0	78,0	380	85	50,0	39,0	07001480
M 88	6,0	82,0	380	85	50,0	39,0	07001490
M 90	6,0	84,0	380	85	50,0	39,0	07001500
M 92	6,0	86,0	400	90	56,0	44,0	07001510
M 96	6,0	90,0	400	90	56,0	44,0	07001520
M 100	6,0	94,0	400	90	56,0	44,0	07001530

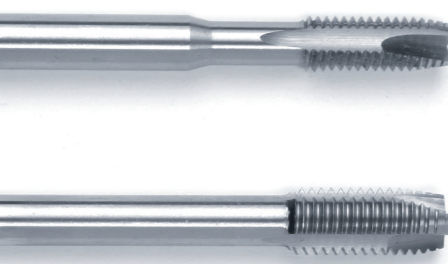

МАШИННЫЙ МЕТЧИК



ТЕХНИЧЕСКАЯ ИНФОРМАЦИЯ

Норма	DIN 371 (DIN 2184-1)	Вид отверстия	глухое < 1.1/2xd
Резьба	M	Направление	правый
Материал	VHM	Класс точности	6h
Форма	Форма С	Обр. Материал	Сталь до 92 HRC

Машинный метчик с проходным хвостовиком, 2-3 витка резьбы

М	мм	мм	мм	мм	мм	мм	Арт.-Нр.
M 2	0,4	1,6	45	8	2,8	2,1	07002080
M 2,2	0,45	1,75	45	9	2,8	2,1	07002090
M 2,3	0,4	1,9	45	9	2,8	2,1	07002100
M 2,5	0,45	2,05	50	9	2,8	2,1	07002110
M 2,6	0,45	2,1	50	9	2,8	2,1	07002120
M 3	0,5	2,5	56	11	3,5	2,7	07002130
M 3,5	0,6	2,9	56	12	4,0	3,0	07002140
M 4	0,7	3,3	63	13	4,5	3,4	07002150
M 5	0,8	4,2	70	16	6,0	4,9	07002170
M 6	1,0	5,0	80	19	6,0	4,9	07002190
M 7	1,0	6,0	80	19	7,0	5,5	07002200
M 8	1,25	6,8	90	22	8,0	6,2	07002210
M 10	1,5	8,5	100	24	10,0	8,0	07002230

МАШИННЫЙ МЕТЧИК



ТЕХНИЧЕСКАЯ ИНФОРМАЦИЯ

Норма	DIN 376 (DIN 2184-1)	Вид отверстия	глухое < 1.1/2xd
Резьба	M	Направление	правый
Материал	VHM	Класс точности	6h
Форма	Форма С	Обр. Материал	Сталь до 92 HRC

Машинный метчик с проходным хвостовиком, 2-3 витка резьбы

М	мм	мм	мм	мм	мм	мм	Арт.-Нр.
M 3	0,5	2,5	56	10	2,2	—	07003130
M 4	0,7	3,3	63	12	2,8	2,1	07003150
M 5	0,8	4,2	70	14	3,5	2,7	07003170
M 6	1,0	5,0	80	16	4,5	3,4	07003190
M 8	1,25	6,8	90	18	6,0	4,9	07003210
M 10	1,5	8,5	100	20	7,0	5,5	07003230
M 12	1,75	10,2	110	28	9,0	7,0	07003250
M 14	2,0	12,0	110	30	11,0	9,0	07003260
M 16	2,0	14,0	110	32	12,0	9,0	07003270
M 18	2,5	15,5	125	34	14,0	11,0	07003280
M 20	2,5	17,5	140	34	16,0	12,0	07003290
M 22	2,5	19,5	140	34	18,0	14,5	07003300
M 24	3,0	21,0	160	38	18,0	14,5	07003310
M 27	3,0	24,0	160	38	20,0	16,0	07003320
M 30	3,5	26,5	180	45	22,0	18,0	07003330
M 33	3,5	29,5	180	50	25,0	20,0	07003340
M 36	4,0	32,0	200	56	28,0	22,0	07003350
M 39	4,0	35,0	200	60	32,0	24,0	07003360
M 42	4,5	37,5	200	60	32,0	24,0	07003370
M 45	4,5	40,5	220	65	36,0	29,0	07003380
M 48	5,0	43,0	250	70	36,0	29,0	07003390
M 52	5,0	47,0	250	70	40,0	32,0	07003400
M 56	5,5	51,5	250	70	40,0	32,0	07003410
M 60	5,5	54,5	280	75	45,0	35,0	07003420
M 64	6,0	58,0	315	80	50,0	39,0	07003430
M 68	6,0	62,0	315	80	50,0	39,0	07003440
M 72	6,0	66,0	340	80	50,0	39,0	07003450
M 76	6,0	70,0	340	80	50,0	39,0	07003460
M 80	6,0	74,0	360	85	50,0	39,0	07003470
M 84	6,0	78,0	380	85	50,0	39,0	07003480
M 88	6,0	82,0	380	85	50,0	39,0	07003490
M 90	6,0	84,0	380	85	50,0	39,0	07003500
M 92	6,0	86,0	400	90	56,0	44,0	07003510
M 96	6,0	90,0	400	90	56,0	44,0	07003520
M 100	6,0	94,0	400	90	56,0	44,0	07003530

МАШИННЫЙ МЕТЧИК

ТЕХНИЧЕСКАЯ ИНФОРМАЦИЯ



Норма	DIN 371 (DIN 2184-1)	Вид отверстия	глухое < 2хd
Резьба	M	Направление	правый
Материал	VHM	Класс точности	6h
Форма	Форма C/RSP 15°	Обр. Материал	Сталь до 92 HRC

Машинный метчик с утолщённым хвостовиком, со спиральной канавкой 15 градусов, 2-3 витка резьбы

Иконка	М	М	М	М	М	М	Арт.-Нр.
	0,4	1,6	45	8	2,8	2,1	07004080
	0,45	1,75	45	9	2,8	2,1	07004090
	0,4	1,9	45	9	2,8	2,1	07004100
	0,45	2,05	50	9	2,8	2,1	07004110
	0,45	2,1	50	9	2,8	2,1	07004120
	0,5	2,5	56	11	3,5	2,7	07004130
	0,6	2,9	56	12	4,0	3,0	07004140
	0,7	3,3	63	13	4,5	3,4	07004150
	0,8	4,2	70	16	6,0	4,9	07004170
	1,0	5,0	80	19	6,0	4,9	07004190
	1,0	6,0	80	19	7,0	5,5	07004200
	1,25	6,8	90	22	8,0	6,2	07004210
	1,5	8,5	100	24	10,0	8,0	07004230

МАШИННЫЙ МЕТЧИК

ТЕХНИЧЕСКАЯ ИНФОРМАЦИЯ



Норма	DIN 376 (DIN 2184-1)	Вид отверстия	глухое < 2хd
Резьба	M	Направление	правый
Материал	VHM	Класс точности	6h
Форма	Форма C/RSP 15°	Обр. Материал	Сталь до 92 HRC

Машинный метчик с проходным хвостовиком, со спиральной канавкой 15 градусов, 2-3 витка резьбы

Иконка	М	М	М	М	М	М	Арт.-Нр.
	0,5	2,5	56	10	2,2	—	07005130
	0,7	3,3	63	12	2,8	2,1	07005150
	0,8	4,2	70	14	3,5	2,7	07005170
	1,0	5,0	80	16	4,5	3,4	07005190
	1,25	6,8	90	18	6,0	4,9	07005210
	1,5	8,5	100	20	7,0	5,5	07005230
	1,75	10,2	110	28	9,0	7,0	07005250
	2,0	12,0	110	30	11,0	9,0	07005260
	2,0	14,0	110	32	12,0	9,0	07005270
	2,5	15,5	125	34	14,0	11,0	07005280
	2,5	17,5	140	34	16,0	12,0	07005290
	2,5	19,5	140	34	18,0	14,5	07005300
	3,0	21,0	160	38	18,0	14,5	07005310
	3,0	24,0	160	38	20,0	16,0	07005320
	3,5	26,5	180	45	22,0	18,0	07005330
	3,5	29,5	180	50	25,0	20,0	07005340
	4,0	32,0	200	56	28,0	22,0	07005350
	4,0	35,0	200	60	32,0	24,0	07005360
	4,5	37,5	200	60	32,0	24,0	07005370
	4,5	40,5	220	65	36,0	29,0	07005380
	5,0	43,0	250	70	36,0	29,0	07005390
	5,0	47,0	250	70	40,0	32,0	07005400
	5,5	51,5	250	70	40,0	32,0	07005410
	5,5	54,5	280	75	45,0	35,0	07005420
	6,0	58,0	315	80	50,0	39,0	07005430
	6,0	62,0	315	80	50,0	39,0	07005440
	6,0	66,0	340	80	50,0	39,0	07005450
	6,0	70,0	340	80	50,0	39,0	07005460
	6,0	74,0	360	85	50,0	39,0	07005470
	6,0	78,0	380	85	50,0	39,0	07005480
	6,0	82,0	380	85	50,0	39,0	07005490
	6,0	84,0	380	85	50,0	39,0	07005500
	6,0	86,0	400	90	56,0	44,0	07005510
	6,0	90,0	400	90	56,0	44,0	07005520
	6,0	94,0	400	90	56,0	44,0	07005530



МАШИННЫЙ МЕТЧИК



ТЕХНИЧЕСКАЯ ИНФОРМАЦИЯ

Норма	DIN 371 (DIN 2184-1)	Вид отверстия	глухое < 3хd
Резьба	M	Направление	правый
Материал	VHM	Класс точности	6h
Форма	Форма C/RSP 35°	Обр. Материал	Сталь до 92 HRC

Машинный метчик с утолщённым хвостовиком, со спиральной канавкой 35 градусов, 2-3 витка резьбы

Иконка	М	мм	мм	мм	мм	мм	мм	Арт.-Нр.
Иконка	M 2	0,4	1,6	45	8	2,8	2,1	07006080
Иконка	M 2,2	0,45	1,75	45	9	2,8	2,1	07006090
Иконка	M 2,3	0,4	1,9	45	9	2,8	2,1	07006100
Иконка	M 2,5	0,45	2,05	50	9	2,8	2,1	07006110
Иконка	M 2,6	0,45	2,1	50	9	2,8	2,1	07006120
Иконка	M 3	0,5	2,5	56	7	3,5	2,7	07006130
Иконка	M 3,5	0,6	2,9	56	7	4,0	3,0	07006140
Иконка	M 4	0,7	3,3	63	8	4,5	3,4	07006150
Иконка	M 5	0,8	4,2	70	10	6,0	4,9	07006170
Иконка	M 6	1,0	5,0	80	12	6,0	4,9	07006190
Иконка	M 7	1,0	6,0	80	12	7,0	5,5	07006200
Иконка	M 8	1,25	6,8	90	16	8,0	6,2	07006210
Иконка	M 10	1,5	8,5	100	16	10,0	8,0	07006230

МАШИННЫЙ МЕТЧИК



ТЕХНИЧЕСКАЯ ИНФОРМАЦИЯ

Норма	DIN 376 (DIN 2184-1)	Вид отверстия	глухое < 3хd
Резьба	M	Направление	правый
Материал	VHM	Класс точности	6h
Форма	Форма C/RSP 35°	Обр. Материал	Сталь до 92 HRC

Машинный метчик с проходным хвостовиком, со спиральной канавкой 35 градусов, 2-3 витка резьбы

Иконка	М	мм	мм	мм	мм	мм	мм	Арт.-Нр.
Иконка	M 3	0,5	2,5	56	7	2,2	—	07007130
Иконка	M 4	0,7	3,3	63	8	2,8	2,1	07007150
Иконка	M 5	0,8	4,2	70	10	3,5	2,7	07007170
Иконка	M 6	1,0	5,0	80	12	4,5	3,4	07007190
Иконка	M 8	1,25	6,8	90	16	6,0	4,9	07007210
Иконка	M 10	1,5	8,5	100	16	7,0	5,5	07007230
Иконка	M 12	1,75	10,2	110	18	9,0	7,0	07007250
Иконка	M 14	2,0	12,0	110	20	11,0	9,0	07007260
Иконка	M 16	2,0	14,0	110	22	12,0	9,0	07007270
Иконка	M 18	2,5	15,5	125	25	14,0	11,0	07007280
Иконка	M 20	2,5	17,5	140	25	16,0	12,0	07007290
Иконка	M 22	2,5	19,5	140	25	18,0	14,5	07007300
Иконка	M 24	3,0	21,0	160	30	18,0	14,5	07007310
Иконка	M 27	3,0	24,0	160	30	20,0	16,0	07007320
Иконка	M 30	3,5	26,5	180	35	22,0	18,0	07007330
Иконка	M 33	3,5	29,5	180	35	25,0	20,0	07007340
Иконка	M 36	4,0	32,0	200	45	28,0	22,0	07007350
Иконка	M 39	4,0	35,0	200	45	32,0	24,0	07007360
Иконка	M 42	4,5	37,5	200	45	32,0	24,0	07007370
Иконка	M 45	4,5	40,5	220	50	36,0	29,0	07007380
Иконка	M 48	5,0	43,0	250	50	36,0	29,0	07007390
Иконка	M 52	5,0	47,0	250	55	40,0	32,0	07007400
Иконка	M 56	5,5	51,5	250	55	40,0	32,0	07007410
Иконка	M 60	5,5	54,5	280	55	45,0	35,0	07007420
Иконка	M 64	6,0	58,0	315	70	50,0	39,0	07007430
Иконка	M 68	6,0	62,0	315	70	50,0	39,0	07007440
Иконка	M 72	6,0	66,0	340	80	50,0	39,0	07007450
Иконка	M 76	6,0	70,0	340	80	50,0	39,0	07007460
Иконка	M 80	6,0	74,0	360	85	50,0	39,0	07007470
Иконка	M 84	6,0	78,0	380	85	50,0	39,0	07007480
Иконка	M 88	6,0	82,0	380	85	50,0	39,0	07007490
Иконка	M 90	6,0	84,0	380	85	50,0	39,0	07007500
Иконка	M 92	6,0	86,0	400	90	56,0	44,0	07007510
Иконка	M 96	6,0	90,0	400	90	56,0	44,0	07007520
Иконка	M 100	6,0	94,0	400	90	56,0	44,0	07007530

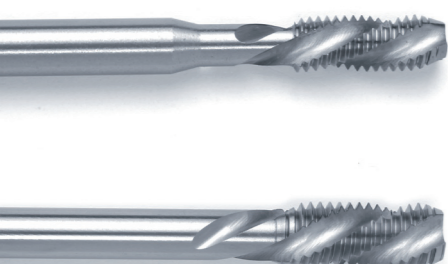

МАШИННЫЙ МЕТЧИК



ТЕХНИЧЕСКАЯ ИНФОРМАЦИЯ

Норма	DIN 2184-1	Вид отверстия	сквозное < 1.1/2xd
Резьба	UNC	Направление	правый
Материал	VHM	Класс точности	6h
Форма	Форма B	Обр. Материал	Сталь до 92 HRC

Машинный метчик ≤ 3/8 с утолщённым хвостовиком, 4–5 витков резьбы, с прямой канавкой

							Арт.-Нр.
UNC Nr. 2	56	1,8	45	9	2,8	2,1	07008020
UNC Nr. 3	48	2,1	50	9	2,8	2,1	07008030
UNC Nr. 4	40	2,3	56	11	3,5	2,7	07008040
UNC Nr. 5	40	2,6	56	11	3,5	2,7	07008050
UNC Nr. 6	32	2,9	56	12	4,0	3,0	07008060
UNC Nr. 8	32	3,5	63	13	4,5	3,4	07008080
UNC Nr. 10	24	3,9	70	15	6,0	4,9	07008100
UNC Nr. 12	24	4,5	80	16	6,0	4,9	07008120
UNC 1/4	20	5,2	80	17	7,0	5,5	07008130
UNC 5/16	18	6,6	90	22	8	6,2	07008140
UNC 3/8	16	8	100	24	10	8	07008150
UNC 7/16	14	9,4	100	22	8,0	6,2	07008160
UNC 1/2	13	10,8	110	24	9,0	7,0	07008170
UNC 9/16	12	12,3	110	26	11,0	9,0	07008180
UNC 5/8	11	13,5	110	27	12,0	9,0	07008190
UNC 3/4	10	16,5	125	30	14,0	11,0	07008210
UNC 7/8	9	19,5	140	32	18,0	14,5	07008230
UNC 1	8	22,3	160	36	20,0	16,0	07008250
UNC 1.1/8	7	25,0	180	40	22,0	18,0	07008260
UNC 1.1/4	7	28,3	180	40	22,0	18,0	07008270
UNC 1.3/8	6	30,8	200	45	28,0	22,0	07008280
UNC 1.1/2	6	34,0	200	45	32,0	24,0	07008290
UNC 1.5/8	6	37,1	200	56	32,0	24,0	07008300
UNC 1.3/4	5	39,5	220	63	36,0	29,0	07008310
UNC 1.7/8	4,5	42,0	220	63	36,0	29,0	07008320
UNC 2	4,5	45,0	250	70	40,0	32,0	07008330
UNC 2.1/4	4,5	51,5	280	75	45	35	07008340
UNC 2.1/2	4	57,2	315	80	50	39	07008350
UNC 2.3/4	4	63,25	340	80	50	39	07008360
UNC 3	4	69,85	360	85	50	39	07008370

МАШИННЫЙ МЕТЧИК



ТЕХНИЧЕСКАЯ ИНФОРМАЦИЯ

Норма	DIN 2184-1	Вид отверстия	глухое < 1.1/2xd
Резьба	UNC	Направление	правый
Материал	VHM	Класс точности	6h
Форма	Форма C	Обр. Материал	Сталь до 92 HRC

Машинный метчик ≤ 3/8 с утолщённым хвостовиком, 2-3 витка резьбы, с прямой канавкой

							Арт.-Нр.
UNC Nr. 4	40	2,3	56	11	3,5	2,7	07010040
UNC Nr. 5	40	2,6	56	11	3,5	2,7	07010050
UNC Nr. 6	32	2,9	56	12	4,0	3,0	07010060
UNC Nr. 8	32	3,5	63	13	4,5	3,4	07010080
UNC Nr. 10	24	3,9	70	15	6,0	4,9	07010100
UNC Nr. 12	24	4,5	80	16	6,0	4,9	07010120
UNC 1/4	20	5,2	80	17	7,0	5,5	07010130
UNC 5/16	18	6,6	90	20	8,0	6,2	07010140
UNC 3/8	16	8,0	100	22	9,0	7,0	07010150
UNC 7/16	14	9,4	100	22	8,0	6,2	07010160
UNC 1/2	13	10,8	110	24	9,0	7,0	07010170
UNC 9/16	12	12,3	110	26	11,0	9,0	07010180
UNC 5/8	11	13,5	110	27	12,0	9,0	07010190
UNC 3/4	10	16,5	125	30	14,0	11,0	07010210
UNC 7/8	9	19,5	140	32	18,0	14,5	07010230
UNC 1	8	22,3	160	36	20,0	16,0	07010250
UNC 1.1/8	7	25,0	180	40	22,0	18,0	07010260
UNC 1.1/4	7	28,3	180	40	22,0	18,0	07010270
UNC 1.3/8	6	30,8	200	45	28,0	22,0	07010280
UNC 1.1/2	6	34,0	200	45	32,0	24,0	07010290
UNC 1.5/8	6	37,10	200	56	32,0	24,0	07010300
UNC 1.3/4	5	39,5	220	63	36,0	29,0	07010310
UNC 1.7/8	4,5	42,0	220	63	36,0	29,0	07010320
UNC 2	4,5	45,0	250	70	40,0	32,0	07010330
UNC 2.1/4	4,5	51,5	280	75	45	35	07010340
UNC 2.1/2	4	57,2	315	80	50	39	07010350
UNC 2.3/4	4	63,25	340	80	50	39	07010360
UNC 3	4	69,85	360	85	50	39	07010370

МАШИННЫЙ МЕТЧИК



ТЕХНИЧЕСКАЯ ИНФОРМАЦИЯ

Норма	DIN 2182	Вид отверстия	глухое < 3хd
Резьба	UNC	Направление	правый
Материал	VHM	Класс точности	6h
Форма	Форма С / RSP 35°	Обр. Материал	Сталь до 92 HRC

Машинный метчик ≤ 3/8 с утолщённым хвостовиком, со спиральной канавкой 35 градусов, 2-3 витка резьбы

							Арт.-Нр.
UNC Nr. 2	56	1,8	45	5	2,8	2,1	07009020
UNC Nr. 3	48	2,1	50	5	2,8	2,1	07009030
UNC Nr. 4	40	2,3	56	5	3,5	2,7	07009040
UNC Nr. 5	40	2,6	56	5	3,5	2,7	07009050
UNC Nr. 6	32	2,9	56	6	4,0	3,0	07009060
UNC Nr. 8	32	3,5	63	7	4,5	3,4	07009080
UNC Nr. 10	24	3,9	70	9	6,0	4,9	07009100
UNC Nr. 12	24	4,5	80	9	6,0	4,9	07009120
UNC 1/4	20	5,2	80	10	7,0	5,5	07009130
UNC 5/16	18	6,6	90	12	8,0	6,2	07009140
UNC 3/8	16	8,0	100	14	9,0	7,0	07009150
UNC 7/16	14	9,4	100	16	8,0	6,2	07009160
UNC 1/2	13	10,8	110	18	9,0	7,0	07009170
UNC 9/16	12	12,3	110	18	11,0	9,0	07009180
UNC 5/8	11	13,5	110	20	12,0	9,0	07009190
UNC 3/4	10	16,5	125	25	14,0	11,0	07009210
UNC 7/8	9	19,5	140	28	18,0	14,5	07009230
UNC 1	8	22,3	160	32	20,0	16,0	07009250
UNC 1.1/8	7	25,0	180	36	22,0	18,0	07009260
UNC 1.1/4	7	28,3	180	36	22,0	18,0	07009270
UNC 1.3/8	6	30,8	200	40	28,0	22,0	07009280
UNC 1.1/2	6	34,0	200	45	32,0	24,0	07009290
UNC 1.5/8	6	37,1	200	45	32,0	24,0	07009300
UNC 1.3/4	5	39,5	220	52	36,0	29,0	07009310
UNC 1.7/8	4,5	42,0	220	52	36,0	29,0	07009320
UNC 2	4,5	45,0	250	60	40,0	32,0	07009330
UNC 2.1/4	4,5	51,5	280	75	45	35	07009340
UNC 2.1/2	4	57,2	315	80	50	39	07009350
UNC 2.3/4	4	63,25	340	80	50	39	07009360
UNC 3	4	69,85	360	85	50	39	07009370

МАШИННЫЙ МЕТЧИК



ТЕХНИЧЕСКАЯ ИНФОРМАЦИЯ

Норма	DIN 2182	Вид отверстия	сквозное < 1.1/2xd
Резьба	UNF	Направление	правый
Материал	VHM	Класс точности	6h
Форма	Форма В	Обр. Материал	Сталь до 92 HRC

Машинный метчик ≤ 3/8 с утолщённым хвостовиком, 4-5 витков резьбы, с прямой канавкой

							Арт.-Нр.
UNF Nr. 2	64	1,85	45	9	2,8	2,1	07011020
UNF Nr. 3	56	2,1	50	9	2,8	2,1	07011030
UNF Nr. 4	48	2,4	56	11	3,5	2,7	07011040
UNF Nr. 5	44	2,7	56	11	3,5	2,7	07011050
UNF Nr. 6	40	3,0	56	12	4,0	3,0	07011060
UNF Nr. 8	36	3,5	63	13	4,5	3,4	07011080
UNF Nr. 10	32	4,1	70	15	6,0	4,9	07011100
UNF Nr. 12	28	4,65	80	16	6,0	4,9	07011120
UNF 1/4	28	5,5	80	17	7,0	5,5	07011130
UNF 5/16	24	6,9	90	20	8,0	6,2	07011140
UNF 3/8	24	8,5	100	22	9,0	7,0	07011150
UNF 7/16	20	9,9	100	22	8,0	6,2	07011160
UNF 1/2	20	11,5	100	22	9,0	7,0	07011170
UNF 9/16	18	13,0	100	22	11,0	9,0	07011180
UNF 5/8	18	14,5	100	22	12,0	9,0	07011190
UNF 3/4	16	17,5	110	25	14,0	11,0	07011210
UNF 7/8	14	20,5	125	25	18,0	14,5	07011230
UNF 1	12	23,3	140	28	18,0	14,5	07011250
UNF 1.1/8	12	26,5	150	28	22,0	18,0	07011270
UNF 1.1/4	12	29,5	150	28	22,0	18,0	07011280
UNF 1.3/8	12	32,5	170	30	28,0	22,0	07011290
UNF 1.1/2	12	36,0	170	30	28,0	22,0	07011300

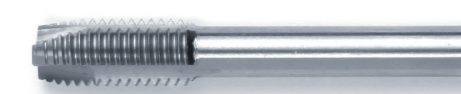

МАШИННЫЙ МЕТЧИК



ТЕХНИЧЕСКАЯ ИНФОРМАЦИЯ

Норма	DIN 2182	Вид отверстия	сквозное < 1.1/2xd
Резьба	UNF	Направление	правый
Материал	VHM	Класс точности	6h
Форма	Форма С	Обр. Материал	Сталь до 92 HRC

Машинный метчик ≤ 3/8 с утолщённым хвостовиком, 2-3 витка резьбы, с прямой канавкой

							Арт.-Нр.
UNF Nr. 4	48	2,4	56	11	3,5	2,7	07013040
UNF Nr. 5	44	2,7	56	11	3,5	2,7	07013050
UNF Nr. 6	40	3,0	56	12	4,0	3,0	07013060
UNF Nr. 8	36	3,5	63	13	4,5	3,4	07013080
UNF Nr. 10	32	4,10	70	15	6,0	4,9	07013100
UNF Nr. 12	28	4,65	80	16	6,0	4,9	07013120
UNF 1/4	28	5,5	80	17	7,0	5,5	07013130
UNF 5/16	24	6,9	90	20	8,0	6,2	07013140
UNF 3/8	24	8,5	100	22	9,0	7,0	07013150
UNF 7/16	20	9,9	100	22	8,0	6,2	07013160
UNF 1/2	20	11,5	100	22	9,0	7,0	07013170
UNF 9/16	18	13,0	100	22	11,0	9,0	07013180
UNF 5/8	18	14,5	100	22	12,0	9,0	07013190
UNF 3/4	16	17,5	110	25	14,0	11,0	07013210
UNF 7/8	14	20,5	125	25	18,0	14,5	07013230
UNF 1	12	23,3	140	28	18,0	14,5	07013250
UNF 1.1/8	12	26,5	150	28	22,0	18,0	07013270
UNF 1.1/4	12	29,5	150	28	22,0	18,0	07013280
UNF 1.3/8	12	32,5	170	30	28,0	22,0	07013290
UNF 1.1/2	12	36,0	170	30	28,0	22,0	07013300

МАШИННЫЙ МЕТЧИК



ТЕХНИЧЕСКАЯ ИНФОРМАЦИЯ

Норма	DIN 2182	Вид отверстия	глухое < 3xd
Резьба	UNF	Направление	правый
Материал	VHM	Класс точности	6h
Форма	Форма С / RSP 35°	Обр. Материал	Сталь до 92 HRC

Машинный метчик ≤ 3/8 с утолщённым хвостовиком, со спиральной канавкой 35 градусов, 2-3 витка резьбы

							Арт.-Нр.
UNF Nr. 2	64	1,85	45	5	2,8	2,1	07012020
UNF Nr. 3	56	2,1	50	5	2,8	2,1	07012030
UNF Nr. 4	48	2,4	56	5	3,5	2,4	07012040
UNF Nr. 5	44	2,7	56	5	3,5	2,7	07012050
UNF Nr. 6	40	3,0	56	6	4,0	3,0	07012060
UNF Nr. 8	36	3,5	63	8	4,5	3,4	07012080
UNF Nr. 10	32	4,1	70	8	6,0	4,9	07012100
UNF Nr. 12	28	4,65	80	9	6,0	4,9	07012120
UNF 1/4	28	5,5	80	10	7,0	5,5	07012130
UNF 5/16	24	6,9	90	12	8,0	6,2	07012140
UNF 3/8	24	8,5	100	12	9,0	7,0	07012150
UNF 7/16	20	9,9	100	22	8,0	6,2	07012160
UNF 1/2	20	11,5	100	22	9,0	7,0	07012170
UNF 9/16	18	13,0	100	22	11,0	9,0	07012180
UNF 5/8	18	14,5	100	22	12,0	9,0	07012190
UNF 3/4	16	17,5	110	25	14,0	11,0	07012210
UNF 7/8	14	20,5	125	25	18,0	14,5	07012230
UNF 1	12	23,3	140	28	18,0	14,5	07012250
UNF 1.1/8	12	26,5	150	28	22,0	18,0	07012270
UNF 1.1/4	12	29,5	150	28	22,0	18,0	07012280
UNF 1.3/8	12	32,5	170	30	28,0	22,0	07012290
UNF 1.1/2	12	36,0	170	30	28,0	22,0	07012300

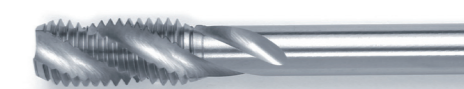



ШЕСТИГРАННЫЙ ХВОСТОВИК ФОРМА E

Круговой паз $\varnothing 4,8$ служит для блокировки и зажима хвостовика. Таким образом выпадывание метчика не возможно. Вид хвостовика и зажима выбирается производителем.



КОМБИ-БИТ-МЕТЧИКИ

с удлинённым шестигранным хвостовиком формы E

Комбинированные бит-метчики для метрических резьб от M3 до M10 предназначены для сверления и нарезки резьбы в коротких сквозных отверстиях (макс. 1х \varnothing). Используются бит-метчики в ручных аккумуляторных машинах для материалов до 600 Н/мм². Данный тип соответствует GSR-стандарту.



M3 M4 M5 M8 M10

ВСЕ С ОДИНАКОВЫМ 1/4" ШЕСТИГРАННЫМ ХВОСТОВИКОМ

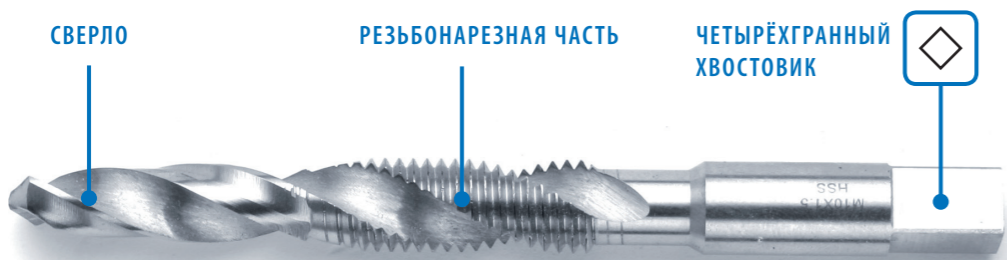

Комбинированные метчики производятся по заводскому стандарту. Они предназначены для сверления и нарезки резьбы одновременно, не меняя при этом инструмент. Они

могут быть использованы в стационарных сверльных машинах с переключаемыми скоростями для сквозных отверстий в материалах с прочностью до 600 Н/мм².

КОМБИНИРОВАННЫЕ МЕТЧИКИ

КОМБИ-БИТ-МЕТЧИКИ

Комбинированные бит-метчики производятся по заводскому стандарту. Они предназначены для сверления, нарезки резьбы и зенкования одновременно. Благодаря шестигранному хвостовику они могут

быть использованы во всех ручных дрелях с переключателем реверса. Они подходят для нарезки резьб с максимальной длиной отверстия 1х \varnothing в материалах с прочностью до 600 Н/мм².



M3 M4 M5 M6 M8



ПАТРОН

КОМБИНИРОВАННЫЕ МАШИННЫЕ МЕТЧИКИ

ТЕХНИЧЕСКАЯ ИНФОРМАЦИЯ



Норма	Заводской стандарт	Вид отверстия	сквозное
Резьба	M	Направление	правый
Материал	HSSE-G	Класс точности	6h
Обр. Материал	VA-Сталь		крестообразная заточка

					Арт.-Нр.
M 3	0,5	2,5	56	2,4	00331030
M 4	0,7	3,3	63	3,0	00331040
M 5	0,8	4,2	71	3,8	00331050
M 6	1,0	5,0	80	4,9	00331060
M 8	1,25	6,8	95	6,2	00331080
M 10	1,5	8,5	106	8,0	00331100
M 12	1,75	10,2	115	9,0	00331120

КОМБИ-БИТ МЕТЧИКИ

ТЕХНИЧЕСКАЯ ИНФОРМАЦИЯ



Норма	Заводской стандарт	Вид отверстия	сквозное < 1хd
Резьба	M	Направление	правый
Материал	HSS-G	Класс точности	6h
Обр. Материал	Сталь		

Комби-бит метчики для сверления, нарезки резьбы и зенкования с шестигранным хвостовиком 1/4" (DIN 3126) и крестообразной заточкой

					Арт.-Нр.
M 3	0,5	2,5	36	1/4"	04501130
M 4	0,7	3,3	39	1/4"	04501150
M 5	0,8	4,2	41	1/4"	04501170
M 6	1	5	44	1/4"	04501190
M 8	1,25	6,8	50	1/4"	04501210
M 10	1,5	8,5	59	1/4"	04501230

НАБОР КОМБИ БИТ МЕТЧИКОВ

ТЕХНИЧЕСКАЯ ИНФОРМАЦИЯ



инкл. 1/4" магнитный удлиннитель для бит-метчиков (DIN 3126)
в металлической кассете



Арт.-Нр.

M3 - M 10 00331400

